

MARINE CORPS DRILL AND CEREMONIES MANUAL

PART II: CEREMONIES

CHAPTER 17

PARADES

	<u>PARAGRAPH</u>	<u>PAGE</u>
GENERAL	17000	17-3
FORMATIONS	17001	17-3
COMMANDER OF TROOPS	17002	17-4
PREPARATION	17003	17-4
SEQUENCE OF EVENTS, PRE-PARADE SERENADE THROUGH THE ADJUTANT TAKING POST	17004	17-4
SEQUENCE OF EVENTS FOR FORMING A BATTALION AND LARGER UNITS .	17005	17-6
SEQUENCE OF EVENTS FOR PRESENTATION OF THE COMMAND	17006	17-8
SEQUENCE OF EVENTS TO MARCH IN REVIEW IN COLUMN FROM A BATTALION LINE, COMPANY LINE FORMATION.	17007	17-13
SEQUENCE OF EVENTS TO MARCH IN REVIEW IN COLUMN FROM A BATTALION LINE, COMPANY MASS FORMATION.	17008	17-16
SEQUENCE OF EVENTS TO MARCH IN REVIEW IN BATTALION COLUMN, COMPANY MASS FORMATION	17009	17-18
TO MARCH IN REVIEW, COMPANIES IN A COLUMN OF PLATOONS IN LINE	17010	17-21
REGIMENTAL PARADES	17011	17-22
BATTALION AND REGIMENTAL FORMATIONS	17012	17-25
STREET PARADES	17013	17-26

FIGURE

17-1	MOVEMENT OF THE BAND.	17-5
17-2	ADJUTANT MOVES TO POST	17-6
17-3	SOUND OFF	17-7
17-4	OFFICERS CENTER	17-9
17-5	POST MARCH.	17-11
17-6	RIGHT FACE.	17-14
17-7	MARCH IN REVIEW, COMPANIES IN COLUMN.	17-15

MARINE CORPS DRILL AND CEREMONIES MANUAL

		<u>PAGE</u>
17-8	COLUMN OF THREES, FROM THE RIGHT.	17-18
17-9	MARCH IN REVIEW, COMPANIES IN MASS.	17-19
17-10	MARCHING IN REVIEW, COMPANIES IN COLUMN OF PLATOONS ON LINE.	17-21
17-11	REGIMENTAL OFFICERS CENTER	17-23
17-12	REGIMENTAL MARCH IN REVIEW	17-24

MARINE CORPS DRILL AND CEREMONIES MANUAL

PART II: CEREMONIES

CHAPTER 17

PARADES

17000. GENERAL. The appearance and movement of troops in formation are the primary considerations of a ceremonial parade. The preparation, organization of troops, and the conduct of a ceremonial parade require familiarity with those chapters for platoon, company, battalion, and regimental drill as well as organizational and parade staff. Normally a parade consists of the following elements:

1. Pre-parade serenade by the band.
2. Forming the staff, and posting the adjutant.
3. March on and formation of the command (forming without a march on is optional).
4. Trooping the colors if appropriate for the type of ceremony.
5. "Sound Off" and trooping the line by the band.
6. The manual of arms.
7. Receiving reports and publishing orders by the adjutant.
8. Officer's center.
9. Presentation of the command and honors to the reviewing officer.
10. Presentation of awards, promotions, retirements, changes of command, relief and appointment of the sergeant major, etc.
11. March in review.
12. Additionally, bayonets may be fixed, if desired, and, at evening parade, retreat may be included as part of the ceremony.

17001. FORMATIONS

1. The battalion is formed per the procedures prescribed in chapter 11 and the regiment is formed per the procedures in chapter 12. The unit commander designates the formation for the parade.
2. The basic formations a commander may choose for battalion parades are:
 - a. Battalion line, company line. Used when space is available or when a larger front is desired for the line of troops.
 - b. Battalion line, company mass (extended mass). Used when the space available for the "front" for the line of troops is limited.

3. The basic formations a commander may choose for regimental parades are:

a. Regiment in line, battalions in line with companies in line or mass (extended mass) formation.

b. Regiment in line, battalions in mass (extended mass).

17002. COMMANDER OF TROOPS. The senior officer taking part in a ceremony is designated as the commander of troops. The commander of troops is responsible for the formation, presentation, and march in review. When a commander acts as the reviewing officer for the parade, the commander designates another officer as commander of troops.

17003. PREPARATION. The line on which troops are to form and along which they are to march is marked out or otherwise designated by the sergeant major or senior enlisted of the unit. The post of the reviewing officer, opposite the center of the line of troops, is marked on each flank with a dress guidon. Additionally, commander's posts, unit guide's posts, and turning points for the approaching the line of troops may also be marked. Paragraph 15007 of this Manual provides details for marking a parade field.

17004. SEQUENCE OF EVENTS, PRE-PARADE SERENADE THROUGH THE ADJUTANT TAKING POST

1. The sequence of events in this paragraph is the same for all parades, regardless of the size of the units participating. The sample LOI on the Marine Corps Drill website will include a sample narration woven into the sequence. Experience has proven this is the best way to keep the commander of troops, adjutant, narrator, etc., synchronized for the parade.

2. H-Hour-15 Minutes

a. The organization is formed in the assembly area. Troops are at parade rest; officers and noncommissioned officers have swords drawn, if so armed. There will be occasions when it will be desired or necessary to form the unit without a march on. In this case the battalion is formed at H-15 on the line of troops, alignment is obtained and the unit is placed at parade rest at which time the sequence continues as outlined in this Chapter.

b. The organizational/parade staff is in position near the reviewing stand.

c. For regimental parades, battalion adjutants take their position behind the line of troops, swords drawn and at parade rest.

d. Narrator introduces the band. The band begins pre-parade serenade.

NARRATOR: "LADIES AND GENTLEMEN, THE MUSIC FOR TODAY'S PRE-PARADE SERENADE IS PROVIDED BY THE MARINE _____ BAND UNDER THE DIRECTION OF _____ . THE DRUM MAJOR IS _____."

3. H-Hour-5 Minutes

a. The band moves to its position on the right of line, countermarches and halts. (See figure 17-1.)

→ b. The commander of troops forms the staff per chapter 14.

Enclosure (1)

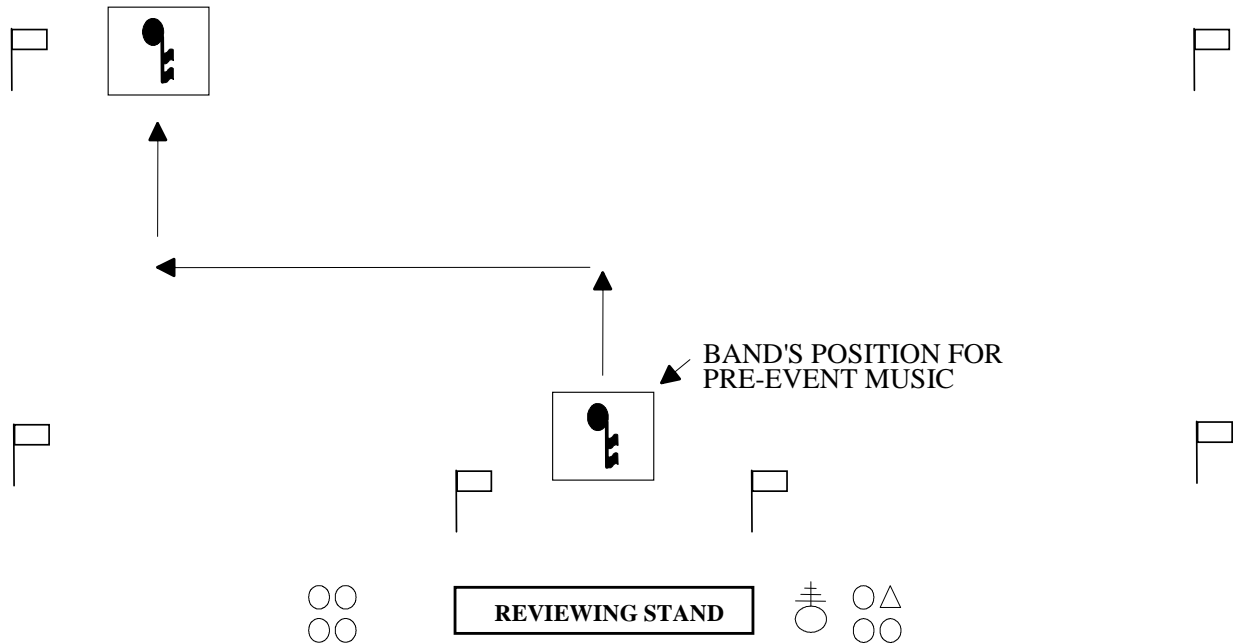

Figure 17-1.--Movement of the Band.

4. H-Hour

- a. Narrator makes opening remarks.

NARRATOR: "GOOD MORNING (EVENING), LADIES AND GENTLEMEN. ON BEHALF OF THE COMMANDING OFFICER (GENERAL), _____, WELCOME TO THE _____ CEREMONY. TODAY'S PARADE IS BEING EXECUTED BY THE OFFICERS AND MARINES OF _____."

(Optional) "LADIES AND GENTLEMEN, PLEASE RISE FOR THE INVOCATION BY COMMAND CHAPLAIN _____, UNITED STATES NAVY."

- b. Invocation is given.

(Note: After the invocation) "LADIES AND GENTLEMEN PLEASE BE SEATED."

- c. Commander of troops commands "TAKE YOUR POST."

d. The adjutant moves by the most direct route to a position on the line of march. (See figure 17-2.)

➔ **NOTE:** at this time, depending on the formation, the command may choose to have the narrator read verbiage similar to the following:

NARRATOR: (AS THE ADJUTANT MOVES INTO POSITION) "PRESENT DAY PARADES IN THE MARINE CORPS HAVE THEIR BASIS IN BOTH HISTORY AND TRADITION, THE MASSED FORMATION OF TROOPS ON ONE LONG LINE AT CLOSE INTERVAL, MADE POSSIBLE THE MASSING OF FIREPOWER FROM MUZZLE LOADED MUSKETS OF YESTERDAY. IN THOSE EARLY DAYS, THE LINE OF BATTLE WAS JUST THAT, A LINE OF TWO OR THREE RANKS, AND LOOKED MUCH LIKE THE PARADE FORMATION YOU WILL SEE TODAY. THE ADJUTANT FORMS THE LINE FOR BATTLE."

Enclosure (1)

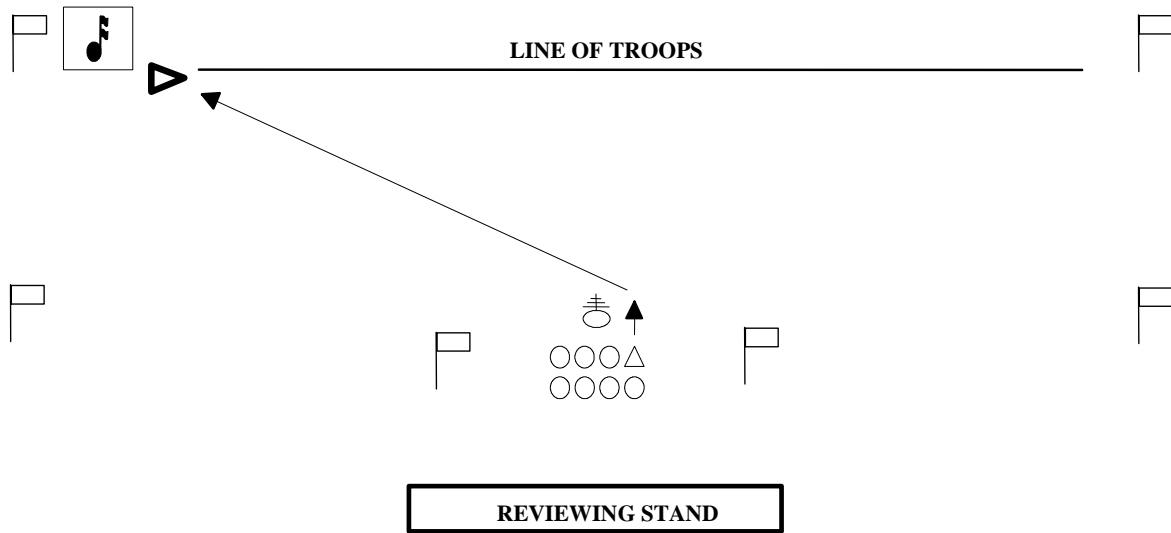

Figure 17-2.--Adjutant Moves to Post.

17005. SEQUENCE OF EVENTS FOR FORMING A BATTALION AND LARGER UNITS

1. To form a battalion for march on see chapter 11.
2. To form a regiment see chapter 12
3. Color Guard

a. If awards, retirements, etc., are a part of the parade the color guard will march onto the parade field with the battalion, when approaching its position on the line of march the color guard will execute a left turn, march forward to their position in the line of troops, mark time, halt and go to order colors. The color guard will execute all commands with the color company except that it will remain at the order during the manual of arms.

b. If no awards, retirements, etc., are a part of the parade and the commander wants to "troop the colors" the color guard would execute a left turn at the extreme left edge of the parade field. It then marches to a position on the left flank of the field, half way between the line of company commanders and the adjutant's position. The color guard executes a right turn and goes to order colors. (See paragraph 7306.)

4. Upon completion of forming the unit and if prescribed for the ceremony, the adjutant next commands "**Fix, BAYONETS.**" After fixing bayonets, or after posting the guide if bayonets are not fixed, the adjutant continues the sequence from paragraph 17005.5 or 17005.9 below as appropriate.

Note: If colors are to be marched on continue the sequence with paragraph 17005.5 below. If colors are not to be marched on skip to paragraph 17005.9.

5. Adjutant commands "**MARCH ON THE COLORS.**" The band plays appropriate music while the color guard, goes to the carry, marches from its position on the left flank, across the front of the battalion along a line parallel to the line of troops and midway between the adjutant and line of company commanders. Company

commanders and the company guide salute the colors as they pass their front. On reaching a point in front of the adjutant, the color guard executes a left turn to face the adjutant and halts, remaining at the carry.

6. Adjutant commands **"Present, ARMS."** The battalion executes present arms. The adjutant salutes the colors.

a. The color guard executes present arms from the carry.

→ b. The band plays either "To the Color" or the "National Anthem." The commander of troops, the staff and the organizational colors salute on the first note of the music and terminate the salute on the last note.

7. Adjutant commands **"Order, ARMS."** The command executes order arms. The color guard returns to carry colors.

8. Adjutant commands **"POST THE COLORS."** The color guard countermarches, moves to the line of troops on the left of the color company, countermarches to face the front, halts, and goes to order colors.

9. Adjutant commands **"Parade, REST"** and **"SOUND OFF."** The battalion, except for the commander of troops, the staff and adjutant go to parade rest. The band sounds off, marches down the line of troops, countermarches, marches back down the line of troops and returns to its position in formation. Once the band is back in position and has stopped playing; (Figure 17-3 depicts the movement of the band during sound off.)

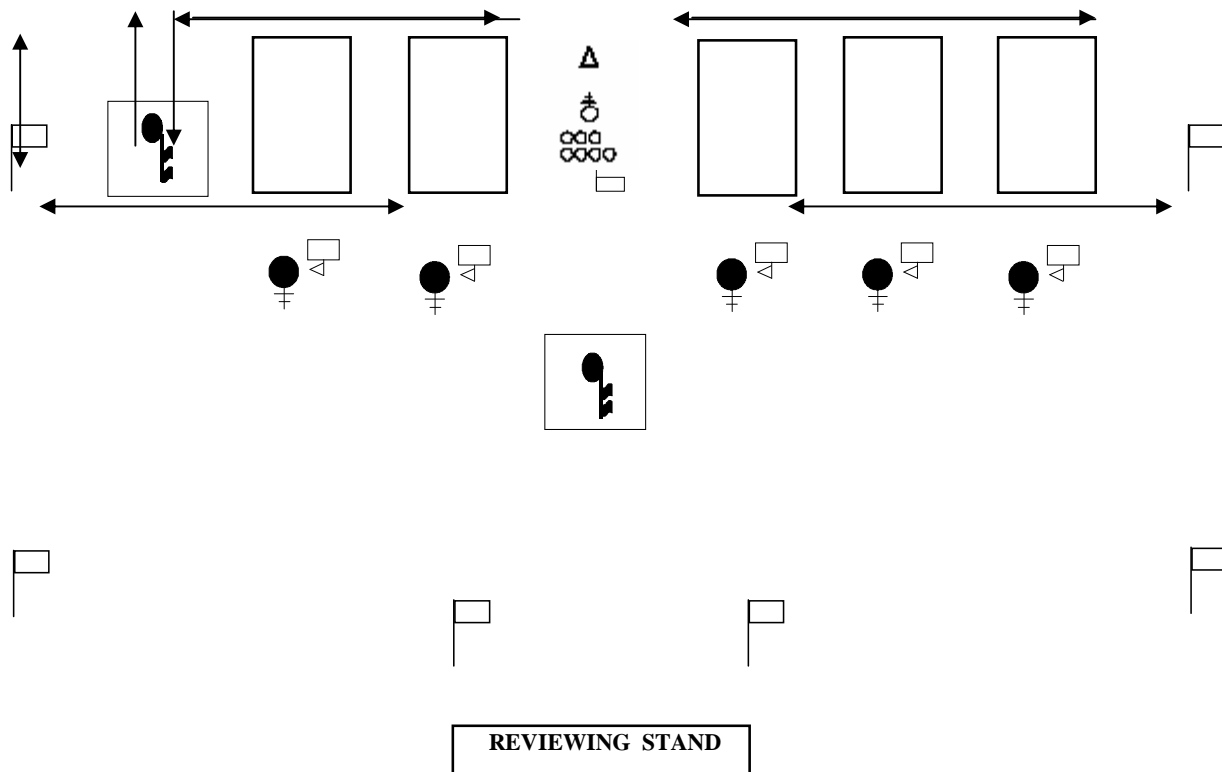

Figure 17-3.--Sound Off.

10. Adjutant commands **"Battalion, ATTENTION"** and **"Present, ARMS."** The battalion executes attention and present arms. The color guard riflemen execute present arms and the colors go to the carry. However, the commander of troops does not receive a salute from the organizational colors unless the commander of troops is the battalion commander or officer of higher rank. Once the battalion is at present arms the adjutant faces the commander of troops and reports.

17006. SEQUENCE OF EVENTS FOR PRESENTATION OF THE COMMAND

1. Adjutant reports **"SIR/MA'AM, THE PARADE IS FORMED."** The commander of troops returns the adjutant's salute.

2. Commander of troops commands **"TAKE YOUR POST."** The adjutant returns to carry swords and marches by the most direct route to the designated post in the staff, halts, faces the line of troops and goes to order sword.

→ 3. Commander of troops commands (only loud enough for the staff to hear) **"Staff, Draw, SWORD"** and **"Staff, Order, SWORD"** (omitted if not armed with swords). The commander of troops remains at carry sword. The commander of troops then exercises the battalion in the manual of arms.

4. Commander of troops commands **"Order, ARMS;" "Port, ARMS;" "Right Shoulder, ARMS;" "Port, ARMS;" "Left Shoulder, ARMS;" "Port, ARMS;"** and **"Order, ARMS."** The battalion executes the manual of arms on the orders of the commander of troops.

a. Company officers and noncommissioned officers execute carry swords of the first command of port arms and return to order swords on the final command of order arms.

b. The color guard remains at the order during the manual of arms.

5. After the manual of arms is completed the commander of troops directs the adjutant to **"RECEIVE THE REPORT, SIR/MA'AM."** The adjutant goes to carry sword and moves to a position 3 paces in front of the commander of troops, facing the line of troops.

6. Adjutant commands **"REPORT."** Company commanders, in succession, from right to left, salute the adjutant with their head and eyes to the front and report, **"___Company, All Present or Accounted For."** The adjutant turns his/her head towards the company commander reporting, but returns the head to the front when returning each company commander's salute. After the last company has reported, the adjutant faces the commander of troops and reports **"Sir/Ma'am, All Present or Accounted For."** The commander of troops returns the adjutant salute, returns to carry sword (the commander of troops remains at carry sword, except when saluting, during the execution of officers center and officers posts).

7. Commander of troops commands **"PUBLISH THE ORDERS."** The adjutant terminates the salute, faces the line of troops and publishes the orders.

8. Adjutant commands **"ATTENTION TO ORDERS."** (Most commands use the following "orders." However, they may be modified to retirement, change of command, relief and appointment orders, etc., at the desire of the commander.)

Enclosure (1)

Note: "Headquarters, ___ Battalion ___ Marines, (date), (month), (year), The Officer of the day today is (rank and name), The Officer of the day tomorrow is (rank and name). By order of (battalion commander's rank and name), United States Marine Corps (Reserve), Commanding."

9. Adjutant commands "**OFFICERS**"--"**CENTER**"--"**MARCH.**" (A sufficient pause between the above command is necessary for the officers and guides to execute the movements.) Figure 17-4 depicts movement for officers center. On the command "**OFFICERS**" the company commanders and platoon commanders go to carry sword, if so armed. The company guide goes to carry guidon.

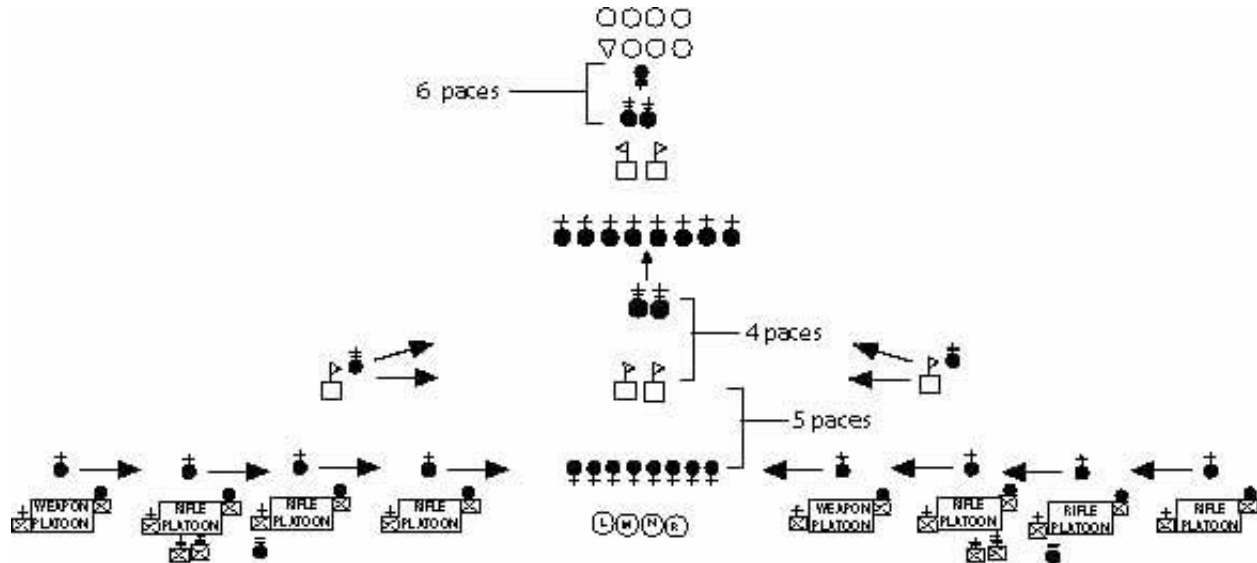

Figure 17-4.--Officers Center.

Note: If the parade is being conducted in conjunction with a review then officers center is omitted.

a. On the command "**CENTER.**"

(1) If in battalion line, company line, company commanders, platoon commanders and company guides face left/right towards the center of the parade field.

(2) If in a battalion line, company mass formation, company commanders and guides face left/right towards the center of the parade field. Platoon commanders take one step forward, halt and then face left/right towards the center of the parade field.

(3) Platoon guides stand fast.

b. On the command "**MARCH.**"

(1) The band starts playing.

(2) The adjutant returns by the most direct route to the designated position in the staff and goes to order sword.

(3) The platoon commanders and guides march directly to their positions in the center of the parade field halt and face left/right towards the commander of troops at close interval.

(4) The company commander's oblique slightly forward in order to form on a line approximately 4 paces in front of the line of guides.

→ 10. Once all officers and guides have halted and faced the commander of troops, the senior company commander commands, "**Officers, Forward, MARCH.**" As the ranks of officers and guides advance towards the commander of troops, alignment is maintained towards the center, with the officer in the center of the leading rank setting the step and direction.

11. As they approach the commander of troops the senior company commander commands "**Officers, HALT.**" The ranks of officers and guides are halted approximately 6 paces from the commander of troops and salute.

a. If armed with swords the officers and guides execute a four-count halt. On the first two counts, the officers and guides execute a halt. On the third count the officers execute the first count of present swords. For the fourth count the officers execute the second count of present swords and the company guides present guidons.

b. If not armed with swords, the officers and company guides execute a four-count halt. On the first two counts, the officers and guides execute a halt. On the third count all pause, and on the fourth count the officers execute a hand salute and the company guides present guidons.

→ c. The commander of troops returns the salute. The commander of troops terminates the salute on the same command which terminates those of the officers' party.

12. Commander of troops commands "**Carry, SWORD**" (If armed with swords) or "**Ready, TWO**" (If not armed with swords).

a. On the command "**Carry,**" the officers execute order swords, if so armed. The guides re-grasp the guidon as the first count of carry guidon. When not armed with swords on the command "**Ready,**" the officers stand-fast and guides re-grasp the guidon as the first count of carry guidon.

b. On the command "**SWORD (TWO)**" the officers go to carry swords, if so armed, and the guides go to carry guidon. If not armed with swords the officers cut their salute. The commander of troops then commands.

13. Commander of troops commands "**POST**"-"**MARCH.**" Figure 17-5 depicts post march.

a. On the command of "**POST,**" all officers and guides execute an about face.

b. On the command of "**MARCH,**" officers and guides step off and march back towards the battalion formation. Alignment is maintained towards the center, with the officer in the center of the leading rank setting the step and direction.

Enclosure (1)

17-10

Ch 1

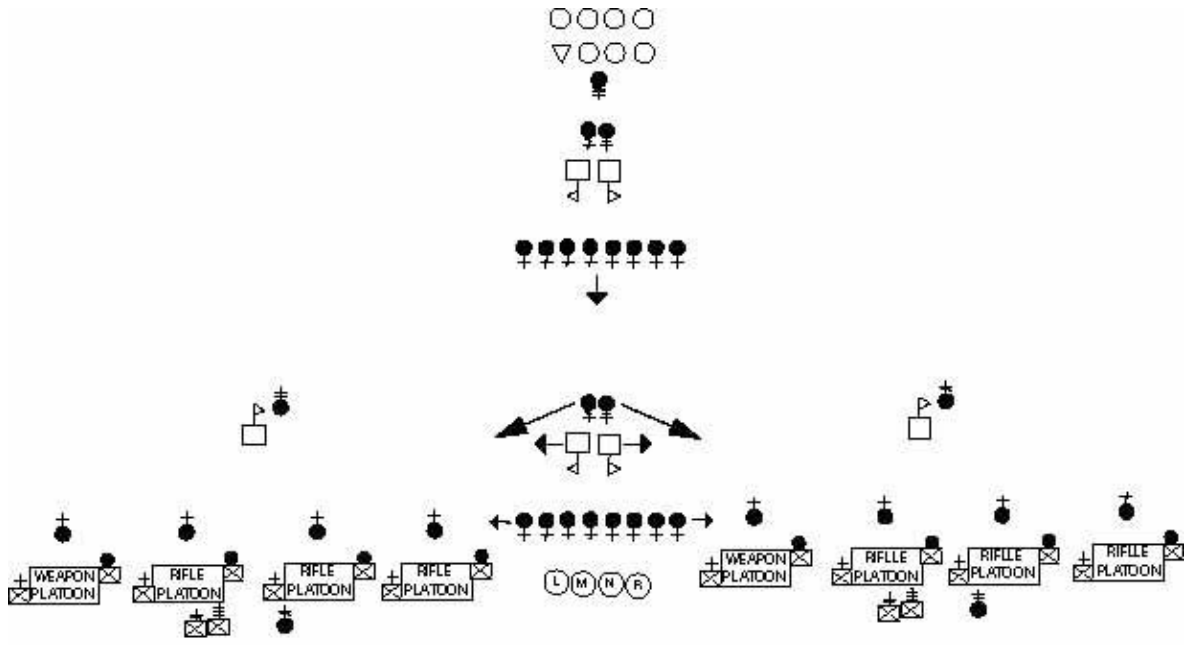

Figure 17-5.--Post March.

14. When the officers are nearing the battalion formation the senior company commander commands "**Officers, HALT;**" and "**POST--"MARCH."**" The officers are halted so that:

a. When in a battalion line, company line, and the rank of platoon commanders are 6 paces from the line of troops.

b. When in a battalion line, company mass, the rank of platoon commanders are 2 paces from the line of troops.

c. On the command of "**POST,**" all officers and guides face left/right in the direction of their companies.

d. On the command of "**MARCH,**" officers and guides step off in succession at 4-pace intervals. (The Marine at the head of each file steps off, then every fourth step the next Marine steps off so as to be in step with the music.) Then, by the most direct route, return to their posts, halt, face front and execute order swords.

→ (1) If in a company mass formation, upon reaching their platoons, the platoon commanders will execute one step to the right/left flank into their position, halt, about face and go to order sword.

(2) Guidon bearers step off with their company commander and when reaching their post, halt, face front and go to order guidon.

(3) Company commanders oblique inboard so that they are 1 pace in front of their guidon bearer upon reaching their post. They halt, face front and go to order swords.

e. When all officers and guides have returned to their posts, and gone to the order, the band stops playing. The commander of troops then, so only the staff can hear, commands.

Enclosure (1)

15. Commander of troops commands **"BOX THE STAFF."** (See paragraph 14002.3.)

a. The adjutant boxes the staff by giving the following commands;

(1) **"Staff, Carry, SWORD"** (if armed with swords).

(2) **"Staff, Left, FACE."**

(3) **"Staff, Column Right, MARCH"** (second column right is executed without command. Once each staff member has reached their new position they automatically mark time).

(4) **"Staff, HALT."**

(5) **"Staff, Right, FACE."**

(6) **"Staff, Order, SWORD"** (if armed with swords).

b. Once the staff is in its new position the commander of troops faces the reviewing area. The reviewing officer then takes position centered between the dress guidons at attention. The commander of troops, seeing the reviewing officer in position, faces the battalion.

Note: If the reviewing officer is a general or flag officer, or civilian that rates "honors" the following sequence will be used beginning with paragraph 17006.16. The procedures for honors and gun salutes are contained in chapter 22. If no musical or gun salutes are due to the reviewing officer skip to paragraph 17006.20.

NARRATOR: "LADIES AND GENTLEMEN, PLEASE RISE FOR HONORS TO (TITLE/RANK AND NAME OF THE PERSON TO RECEIVE HONORS)."

16. Commander of troops commands **"Present, ARMS."** The command executes present arms.

a. The color guard executes present arms from the order. If no musical or gun salute is fired the organizational colors salutes if appropriate. If musical or gun salutes are utilized the organizational colors salutes on the first note of music and returns to the carry on the last note of the music or last gun is fired.

b. Once the battalion is at present arms the commander of troops faces the reviewing area.

17. Commander of troops commands **"Staff, Present, SWORD (ARMS)."** The staff and commander of troops present swords. After honors, if any, the reviewing officer returns the salute of the commander of troops.

18. Commander of troops commands **"Staff, Order, SWORD (ARMS)."** The commander of troops and staff go to order swords. The commander of troops returns to carry sword and faces the battalion.

19. Commander of troops commands **"Order, ARMS."** The battalion executes order arms. The commander of troops then faces the reviewing area.

20. Note. At this time if:

a. The parade is being held as part of a review, refer to chapter 16 and follow that sequence of events.

b. The parade is being held as an awards/retirement ceremony, refer to chapter 18 and follow the sequence of events specified for the presentation of awards/retirement.

c. The parade is being held for a change of command ceremony refer to chapter 19 and follow the sequence of events specified for a change of command.

d. The parade is being held for a relief and appointment of the sergeants major refer to chapter 20 and follow the sequence of events specified for the relief and appointment of the sergeant major.

e. If the parade is being held for an activation/deactivation, or a joint activation/deactivation ceremony refer to chapter 21 and follow the sequence of events for the specific ceremony outlined there.

21. After completing one of the above sequences of events return to this Chapter and continue with the sequence of events for marching in review.

17007. SEQUENCE OF EVENTS TO MARCH IN REVIEW IN COLUMN FROM A BATTALION LINE, COMPANY LINE FORMATION

1. After completing the presentation of awards, retirements, etc., and the battalion is at attention, the commander of troops faces the reviewing officer.

→ 2. Reviewing officer commands "**MARCH THE COMMAND IN REVIEW.**" After exchanging salutes, the commander of troops commands "**Staff, Carry, SWORD,**" and then faces the line of troops.

3. Commander of troops commands "**PASS IN REVIEW**" and "**Right, FACE.**" While the battalion is being prepared to march in review band moves to its position on the line of march.

a. On the command "**PASS IN REVIEW,**" all personnel armed with sword will execute carry sword.

b. On the command of execution "**FACE,**" all hands face to the right. The platoon guides move to their position in front of the right squad. The platoon commanders move to their position at the head of their platoons. The company commanders and company guides then move to their positions at the head of their companies. (See figure 17-6.)

c. The color guard, on the command "**Right, FACE,**" goes to carry colors, executes a right turn, halts and remains at the carry.

4. Commander of troops commands "**Right Shoulder, ARMS.**" The battalion executes right shoulder arms. The commander of troops then glances in the direction of the band to ensure it is ready to march in review. The drum major signifies the band is ready by having halted the band and raising the mace in a high carry position.

Enclosure (1)

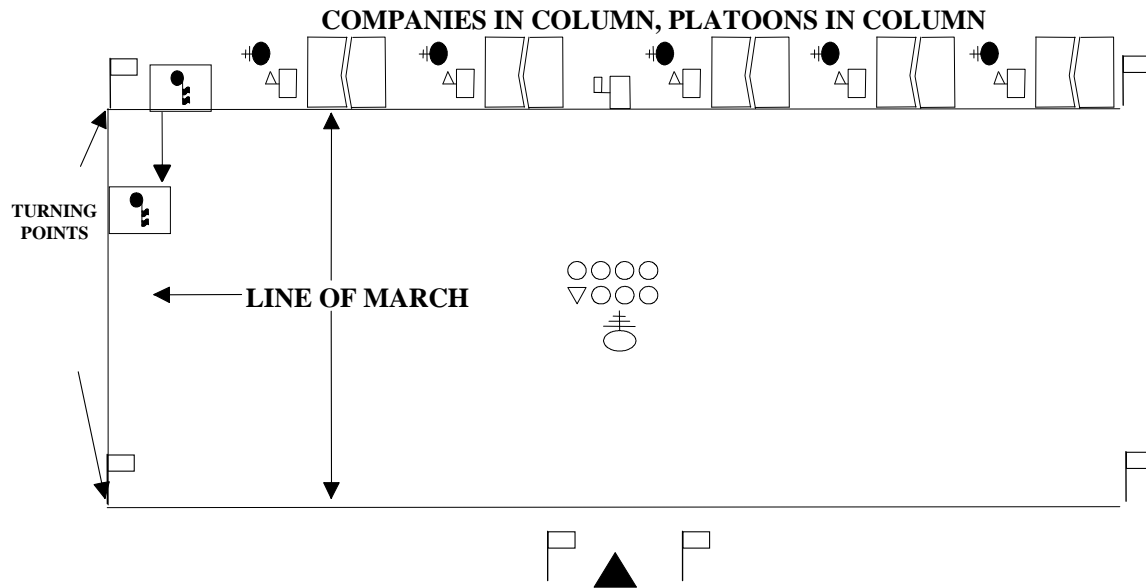

Figure 17-6.--Right Face.

- 5. Commander of troops commands **"Staff, Carry, SWORD"** and **"Forward, MARCH."** The entire battalion steps off and the band plays *"Semper Fidelis"*. The formation quickly adjusts its step so that the left foot strikes the deck in time with the heavy beat of the drum.
- a. The commander of troops and staff step off when the command of execution **"MARCH"** is given by the commander of troops. The commander of troops steps to the left in marching and picks up the half step. The staff executes a right turn from the halt, covers on the commander of troops and picks up the half step. When the staff has completed the turn the commander of troops commands **"Staff, Forward, MARCH."**
 - b. The commander of troops and staff marches down the line and execute two left turns in order to be positioned at the head of the column in front of the band. (See figure 17-7.)
 - c. The company commanders, as they approach each turning point give the command of **"Column Left, MARCH"** for themselves and the company guide. Platoon commanders give their platoons **"Column Left, MARCH"** in order to maintain their positions in the company column. (See figure 17-7.)
 - d. The color guard executes left turns at the turning points.
 - e. All column movements are made "inside" the line formed by the dress guidon. The platoon guides use the dress guidons as markers to set the direction of march for the platoon.
6. As the commander of troops, band, company commanders, platoon commanders and the color guard approach the reviewing area the command of eyes right will be given.

Enclosure (1)

17-14

Ch 1

a. As commander of troops and the staff approach the reviewing area the commander commands **"Staff, Eyes, RIGHT,"** as the reviewing area is cleared, **"Staff, Ready, FRONT."**

→ (1) The commander of troops and the staff continue to march down the line of troops to the end of the reviewing area, or other designated point, where they will turn out of the line of march and be positioned to observe the march in review (e.g., they may execute three right turns, see figure 14-8).

(2) The commander of troops, after the staff is halted, commands **"Staff, Return, SWORD,"** if so armed. The commander of troops gives the commands of **"Hand, SALUTE,"** and **"Ready, TWO,"** as the color guard passes the staff's position.

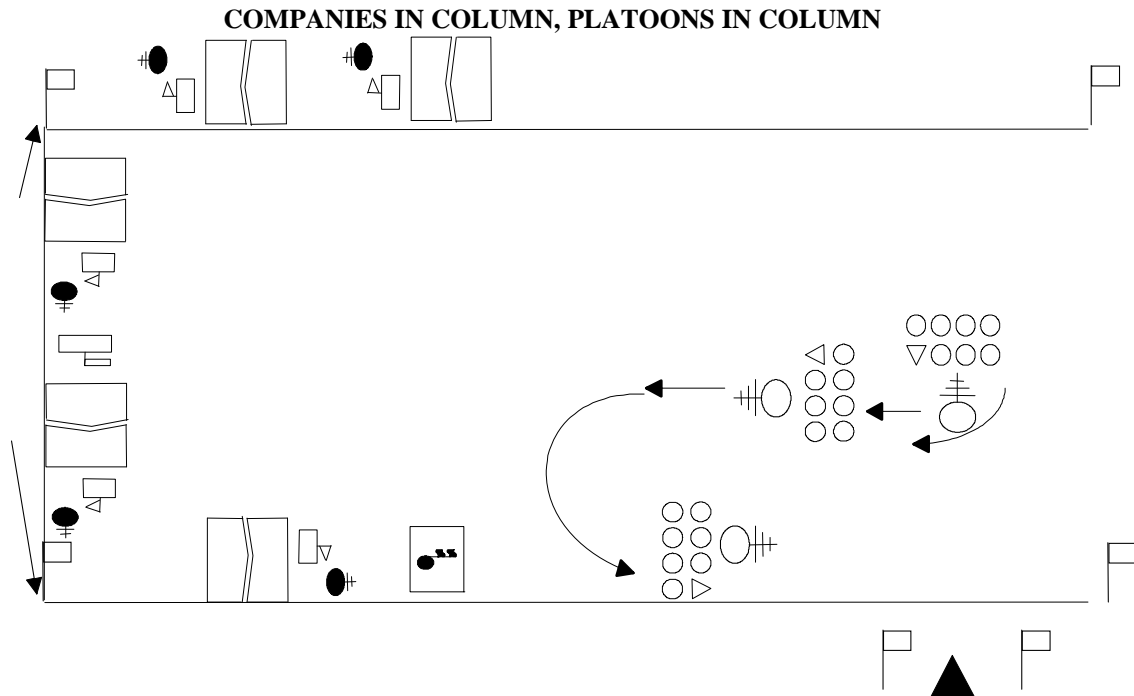

Figure 17-7.--March in Review, Companies in Column.

b. As the band passes the reviewing area the drum major executes an eyes right and salutes for the band. After clearing the reviewing area, the band is marched to a position approximately 30 paces from the reviewing area, centered on and facing the reviewing officer. The band continues to play march music during the march in review.

c. As each company commander approaches the reviewing area the commander gives the command of **"Eyes, RIGHT"** for themselves and the company guide. After passing the second dress guidon the company commander commands **"Ready, FRONT."** The company continues to march down the line of march and from the field.

d. Platoons execute **"Eyes, RIGHT"** on the command of their platoon commander. After the rear of the platoon has cleared the reviewing area the platoon commander then commands **"Ready, FRONT."**

Enclosure (1)

e. The color guard executes eyes right and ready front on command of the senior color bearer per paragraph 7109. The organizational colors salutes during eyes right if the reviewing officer rates such a salute.

7. If armed with swords, only the company commanders and platoon commanders execute a sword salute at eyes right. All other officers and enlisted personnel armed with swords, in the company/platoon formation, continue to march at carry sword.

→ 8. As the last company begins executing eyes right the band plays any special music requests, if required, immediately followed by the "Marines' Hymn." As the "Marines' Hymn" is being played the drum major faces the reviewing officer and salutes. The reviewing officer returns the salute. The band then picks up march music, marches forward, executes a left turn and marches from the field.

9. After the rear element of the command (normally the band) has passed the staff's position and exited the field, the commander of troops faces the reviewing officer, salutes and reports "Sir/Ma'am, The parade is concluded." After the salute is returned the commander of troops may:

- a. Draws sword with the staff and follow the battalion from the field.
- b. Dismiss the staff.

NARRATOR: "LADIES AND GENTLEMEN, THIS CONCLUDES TODAY'S CEREMONY. ON BEHALF OF THE COMMANDING OFFICER (GENERAL), OFFICERS AND MARINES OF _____, THANK YOU FOR YOUR ATTENDANCE."

10. After marching off of the parade ground following the march in review, the color guard and color company return the colors as prescribed in chapter 7. Companies march to their respective areas and are dismissed.

17008. SEQUENCE OF EVENTS TO MARCH IN REVIEW IN COLUMN FROM A BATTALION LINE, COMPANY MASS FORMATION

1. After completing the presentation of awards, retirements, etc., and the battalion is at attention, the commander of troops faces the reviewing officer.

→ 2. Reviewing officer commands "**MARCH THE COMMAND IN REVIEW.**" After exchanging salutes, the commander of troops commands "**Staff, Carry, SWORD,**" and then faces the line of troops.

3. Commander of troops commands "**PASS IN REVIEW,**" all personnel armed with swords will execute carry sword.

a. While the battalion is being prepared to march in review the band moves to its position on the line of march.

b. Company commanders, on the command to pass in review, go to carry sword and face their companies. The company commander of the right company in line begins the pass in review.

4. Company Commander commands "**Right Shoulder, ARMS.**"

- a. The company goes to right shoulder arms.

Enclosure (1)

b. When the company is at right shoulder arms the lead company commander glances in the direction of the band to ensure it is ready to march in review. The drum major signifies the band is ready by having halted the band and raising the mace in a high carry position. The company commander of the right company then commands;

5. Company Commander commands **"Column of Threes (Fours), Right Platoon, Column Right, MARCH."**

a. On the command of execution **"MARCH,"** by the company commander of the right company;

(1) The platoon on the right flank of the company executes a column right from the halt.

→ (2) The band steps off and plays *"Semper Fidelis"*. The formation quickly adjusts its step so that the left foot strikes the deck in time with the heavy beat of the drum.

(3) The company commander and company guide step off and march parallel to the line of troops. They execute a column left at the second change of direction to position themselves in front of the lead platoon of the company at the proper interval.

(4) The commander of troops steps to the left in marching and picks up the half step. The staff executes a right turn from the halt, covers on the commander of troops and picks up the half step. When the staff has completed the turn the commander of troops commands **"Staff, Forward, MARCH."** The commander of troops and staff marches down the line and execute two left turns in order to be positioned at the head of the column in front of the band. (See figure 17-7.)

b. The second and subsequent platoon commanders, seeing their platoons about to be uncovered by the platoon on the right command **"Column Right, MARCH"** so that the platoon is in step with and at the proper interval from the platoon to its front in the column. (See figure 17-8.)

c. Subsequent company commanders give the commands of **"Right Shoulder, ARMS"** and **"Column of Threes (Fours), Right Platoon, Column Right, MARCH"** in order to march their companies in review in step with and at the proper interval from the company to its front in the column.

d. The color guard executes carry colors when the company commander of the color company commands **"Right Shoulder, ARMS."** The color guard then makes those movements necessary to march in review at the proper interval from the color company.

e. The platoon commanders as they approach the first turning point give their platoons **"Column Left, MARCH."** (See figure 17-7.)

f. The color guard executes left turns at the turning points.

Enclosure (1)

17-17

Ch 1

g. All column movements are made "inside" the line formed by the dress guidons. The platoon guides use the dress guidons as markers to set the direction of march for the platoon.

h. The company commanders as they approach the second turning point give the command of "**Column Left, MARCH**" for themselves and the company guides. Platoon commanders give their platoons "**Column Left, MARCH**" in order to maintain their positions in the company column. (See figure 17-7.)

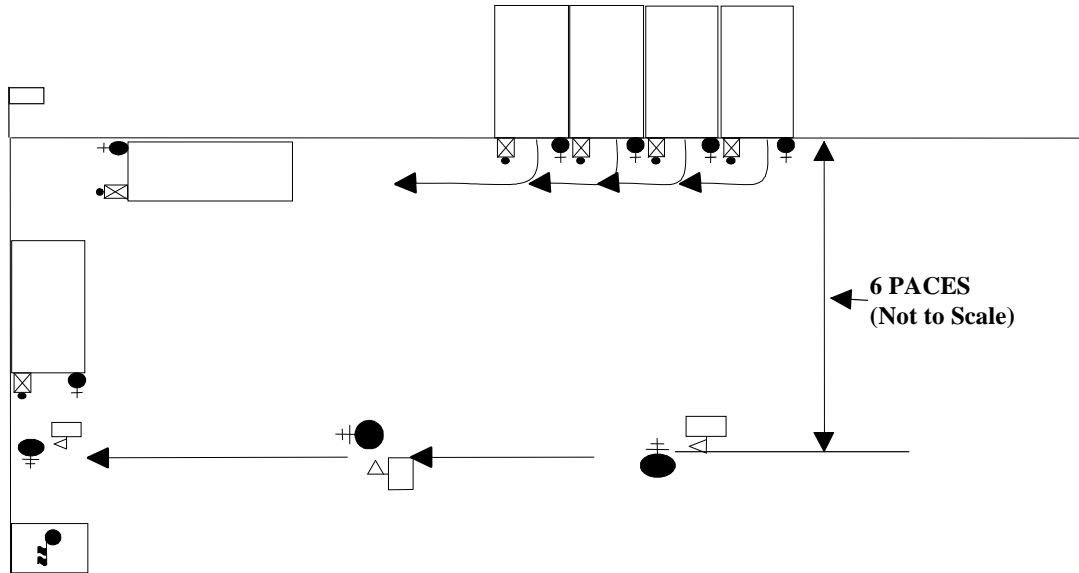

Figure 17-8.--Column of Threes, From the Right.

6. Refer to paragraph 17007.6 for the remainder of the sequence of events for the pass in review.

17009. SEQUENCE OF EVENTS TO MARCH IN REVIEW IN BATTALION COLUMN, COMPANIES IN MASS

1. After completing the presentation of awards, retirements, etc., and the battalion is at attention, the commander of troops faces the reviewing officer.
- 2. Reviewing Officer commands "**MARCH THE COMMAND IN REVIEW.**" After exchanging salutes, the commander of troops commands "**Staff, Carry, SWORD,**" and then faces the line of troops.
3. Commander of troops commands "**PASS IN REVIEW**" and "**Right Shoulder, ARMS.**" The battalion executes right shoulder arms. While the battalion is being prepared to march in review band moves to its position on the line of march.
 - a. On the command of "**PASS IN REVIEW**" all personnel armed with swords will execute carry sword.
 - b. The color guard, on the command of execution "**ARMS,**" goes to carry colors, executes a right turn, halts and remains at the carry.

Enclosure (1)

c. The commander of troops then glances in the direction of the band to ensure it is ready to march in review. The drum major signifies the band is ready by having halted the band and raising the mace in a high carry position. When the band and the battalion is prepared to march in review;

4. Commander of troops commands "**Column of Companies, Right Company, Right Turn-MARCH.**" The right company executes a right turn from the halt and picks up the half step. After the company has completed making the turn the company commander commands "**Forward, MARCH.**"

→ a. The band steps off and plays "*Semper Fidelis*". The formation quickly adjusts its step so that the left foot strikes the deck in time with the heavy beat of the drum.

b. The commander of troops and staff step off on the command of execution "**MARCH.**" The commander of troops steps to the left in marching and picks up the half step. The staff executes a right turn from the halt, covers on the commander of troops and picks up the half step. When the staff has completed the turn the commander of troops commands "**Staff, Forward, MARCH.**"

c. The commander of troops and staff marches down the line and execute two left turns in order to be positioned at the head of the column in front of the band. (See figure 17-7.)

d. The company commanders, as they approach each turning point give the command of "**Left Turn, MARCH**" and "**Forward, MARCH**" to march the company in review. All turning movements are made "inside" the line formed by the dress guidon. The guide of the right platoon of the companies use the dress guidons as markers to set the direction of march for the platoon. (See figure 17-9.)

e. The color guard executes left turns at the turning points.

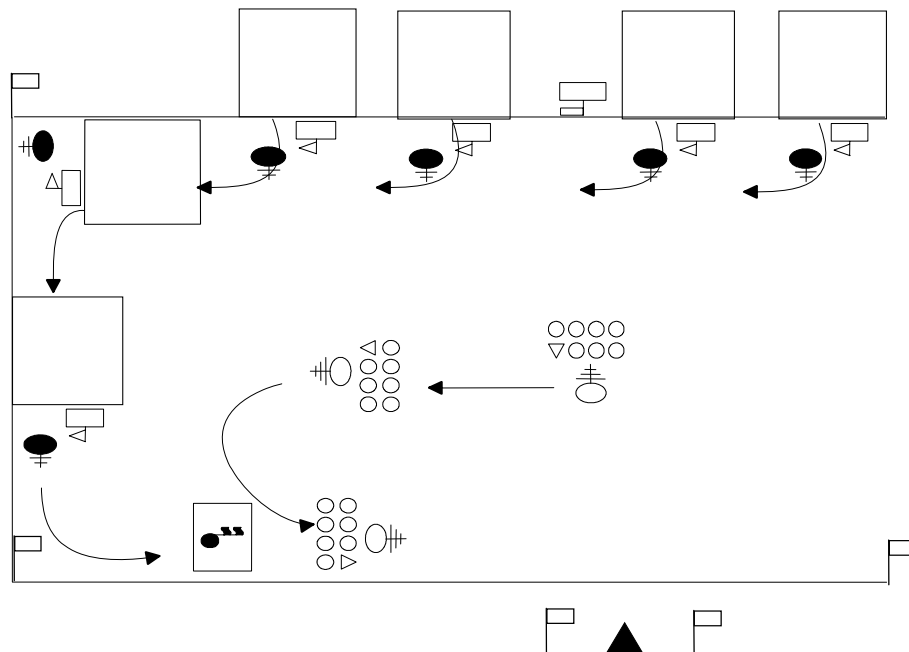

Figure 17-9.--March in Review, Companies in Mass.

Enclosure (1)

5. As the commander of troops, band, company commanders and the color guard approach the reviewing area the command of eyes right will be given;

a. As commander of troops and the staff approach the reviewing area the commander commands **"Staff, Eyes, RIGHT,"** as the reviewing area is cleared, **"Staff, Ready, FRONT."**

(1) The commander of troops and the staff continue to march down the line of troops to the end of the reviewing area, or other designated point, where three right turns are executed in order to place the staff in position to observe the march in review. (See figure 14-8.)

(2) The commander of troops, after the staff is halted, commands the staff to **"Staff, Return, SWORD,"** if so armed. The commander of troops gives the commands of **"Hand, SALUTE,"** and **"Ready, TWO,"** as the color guard passes the staff's position.

b. As the band passes the reviewing area the drum major executes an eyes right and salutes for the band. After clearing the reviewing area, the band is marched to a position approximately 30 paces from the reviewing area, centered on and facing the reviewing officer. The band continues to play march music during the march in review.

c. As each company commander approaches the reviewing area the Marine gives the command of **"Eyes, RIGHT."** The company executes eyes right on the command of the company commander. After the rear of the company has cleared the reviewing area the company commander commands **"Ready, FRONT."** The company continues to march down the line of march and from the field.

d. The color guard executes eyes right and ready front on command of the senior color bearer. The organizational colors salutes during eyes right if the reviewing officer rates such a salute.

e. If armed with swords, only the company commanders and the officers in the front rank of the company execute a sword salute at eyes right. All other officers and noncommissioned officers armed with swords, in the company/platoon formation, continue to march at carry sword.

→ 6. As the last company begins executing eyes right the band plays any special music requests, if required, immediately followed by the *"Marines' Hymn."* As the *"Marines' Hymn"* is being played the drum major faces the reviewing officer and salutes. The reviewing officer returns the salute. The band then picks up march music, marches forward, executes a left turn and marches from the field.

7. After the rear element of the command (normally the band) has passed the staff's position and exited the field, the commander of troops faces the reviewing officer, salutes and reports "Sir/Ma'am, The parade is concluded." After the salute is returned the commander of troops may:

a. Draw sword with the staff and follow the battalion from the field.

b. Dismiss the staff.

NARRATOR: "LADIES AND GENTLEMEN, THIS CONCLUDES TODAY'S CEREMONY. ON BEHALF OF THE COMMANDING OFFICER (GENERAL), OFFICERS AND MARINES OF _____ THANK YOU FOR YOUR ATTENDANCE."

Enclosure (1)

8. After marching off of the parade ground following the march in review, the color guard and color company returns the colors as prescribed in chapter 7. Companies march to their respective areas and are dismissed.

17010. TO MARCH IN REVIEW, COMPANIES IN A COLUMN OF PLATOONS IN LINE

1. The sequence of events to march in review in company column, platoons in line (see figure 17-10) is the same as specified in paragraphs 17008 and 17009 up through the first column left.
2. After making the initial column left, platoon commanders step to the left of the column and position themselves 6 paces front and centered on their platoons.
3. The company commander and company guide execute a left flank approximately 10 paces short of the second turn marker so as to be centered in front of the platoon in line.
4. The platoon commanders give their platoons the command of **"By the Left Flank, MARCH"** so that the platoon guide is marching down the line of march. The guide, after executing the flanking movement moves up to a position beside the first squad leader.
5. When passing the reviewing area the company commander gives the commands **"Eyes, RIGHT"** and **"Ready, FRONT"** for himself/herself and the company guide only.
6. Platoon commanders will give the commands **"Eyes, RIGHT"** and **"Ready, FRONT"** to their platoons.
7. After passing in review, and when reaching the designated spot (far enough away from the reviewing area so as not to interfere with following companies passing in review) the company returns to column formation, by executing a right flank and then executing a column left to depart the field.

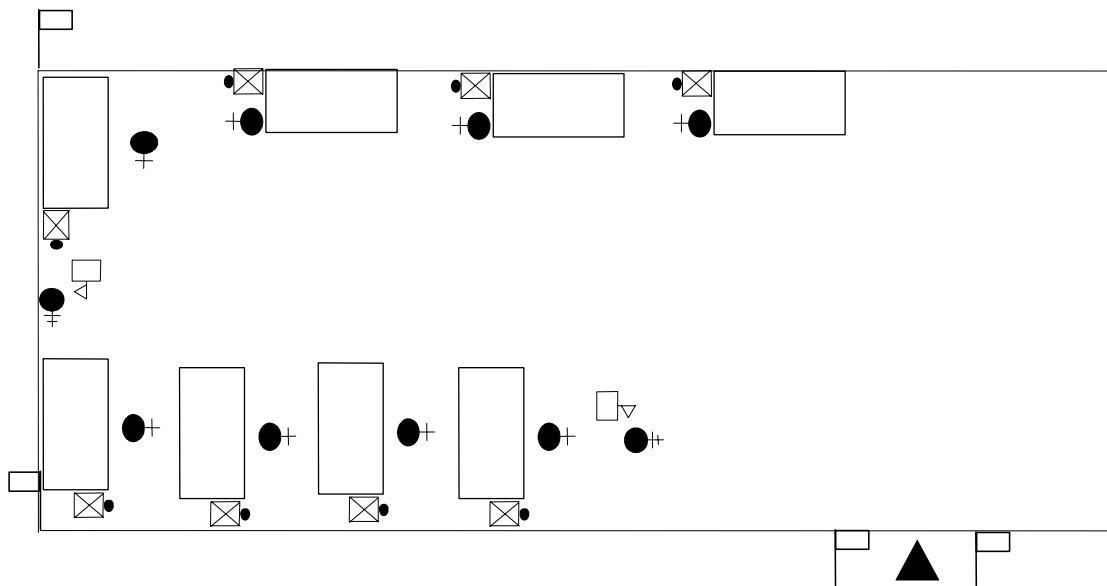

Figure 17-10.--Marching in Review, Companies in Column of Platoons on Line.

17011. REGIMENTAL PARADES. The regiment normally forms in line of battalions with companies in line or in mass formation to conduct ceremonial parades. The parade proceeds as for the battalion with the following exceptions:

1. Regiment is substituted for battalion in description.
2. Battalions and independent companies form the regiment as prescribed in chapter 10 and 11.
3. Battalions and independent companies execute movements on the command of their respective commanders. The battalion and independent company commanders make reports to the regimental adjutant.
4. When trooping the line, after "*Sound Off*," the band passes midway between the line of battalion commanders and the regimental adjutant.
5. During officers center, battalion commanders and staffs close to the center on the original line of battalion commanders. (See figure 17-11.) The battalion commanders remain centered on their staffs. Company commanders oblique forward to close on a line 4 paces behind the line of battalion commanders (and staffs if directed). Guidon bearers oblique forward to close on a line 4 paces behind the line of company commanders. Platoon commanders oblique forward to close on a line 4 paces behind the line of guidon bearers. After officers center, while posting, the staff moves as a unit with their battalion commander.
6. During the march in review, if the parade is being conducted with companies in line formation and after the band has repositioned, the commander of the right battalion or independent company commands "**Right, FACE**" and "**Right Shoulder, ARMS,**" and column of threes is formed. Remaining battalions and independent companies form column of threes and come to right shoulder arms on commands from their respective commanders in succession from right to left. When all units are at right shoulder arms, the commander of the right unit commands "**Forward, MARCH.**" The band steps off playing on this command. Commanders of succeeding units give similar commands to set their units in motion so as to follow at the prescribed distances.
7. During the march in review, if the companies are in mass formation and after the band has repositioned, the commander of the right battalion commands "**Right Shoulder, ARMS;**" and "**Column of Companies, Right Company, Right Turn, MARCH.**" Should an independent company be on the right, its commander commands "**Right Shoulder, ARMS;**" and "**Right Turn, MARCH.**" The band steps off playing with the right unit. Commanders of succeeding units give similar commands to set their units in motion so as to follow at the prescribed distances.
8. During the march in review, battalion commanders and their staffs initially march parallel to the line of troops and take position at the head of their battalions after the first change of direction. The commander of troops and the staff take position at the head of the band after the second change of direction. (See figure 17-12.)

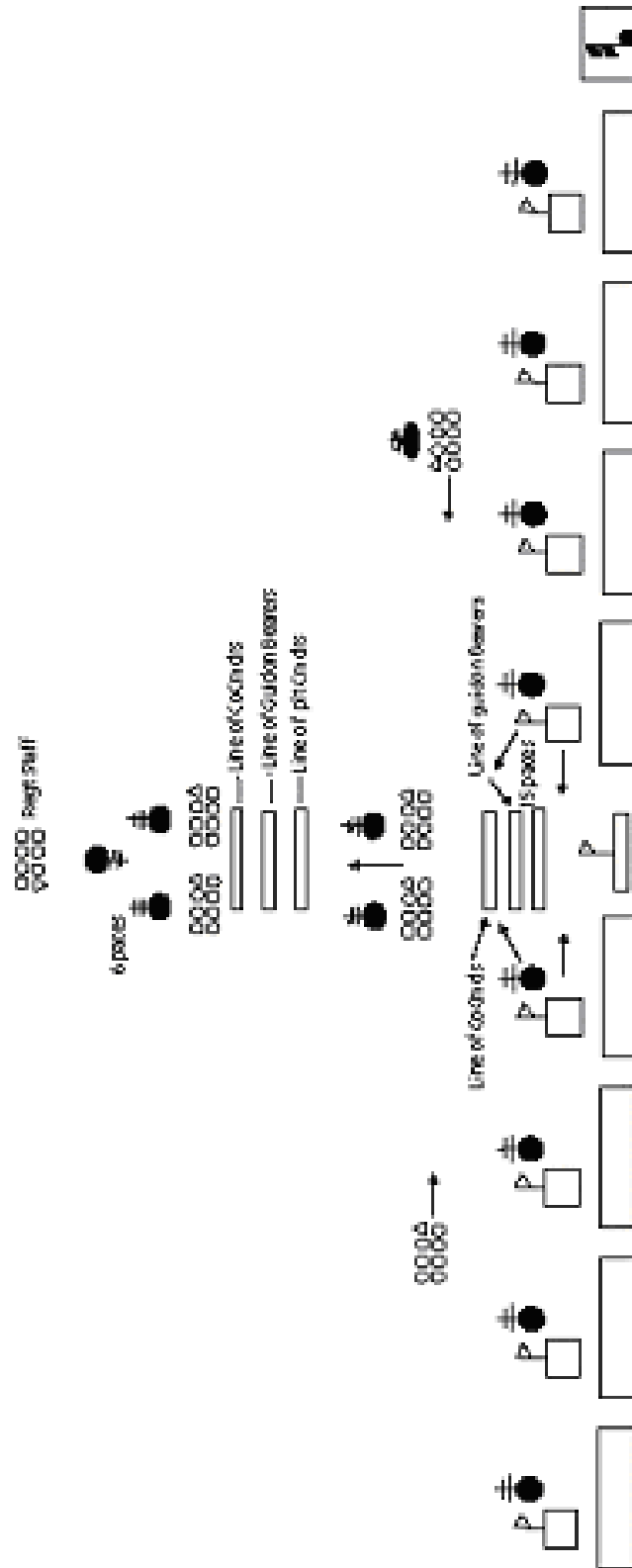

Figure 17-11.--Regimental Officers Center.

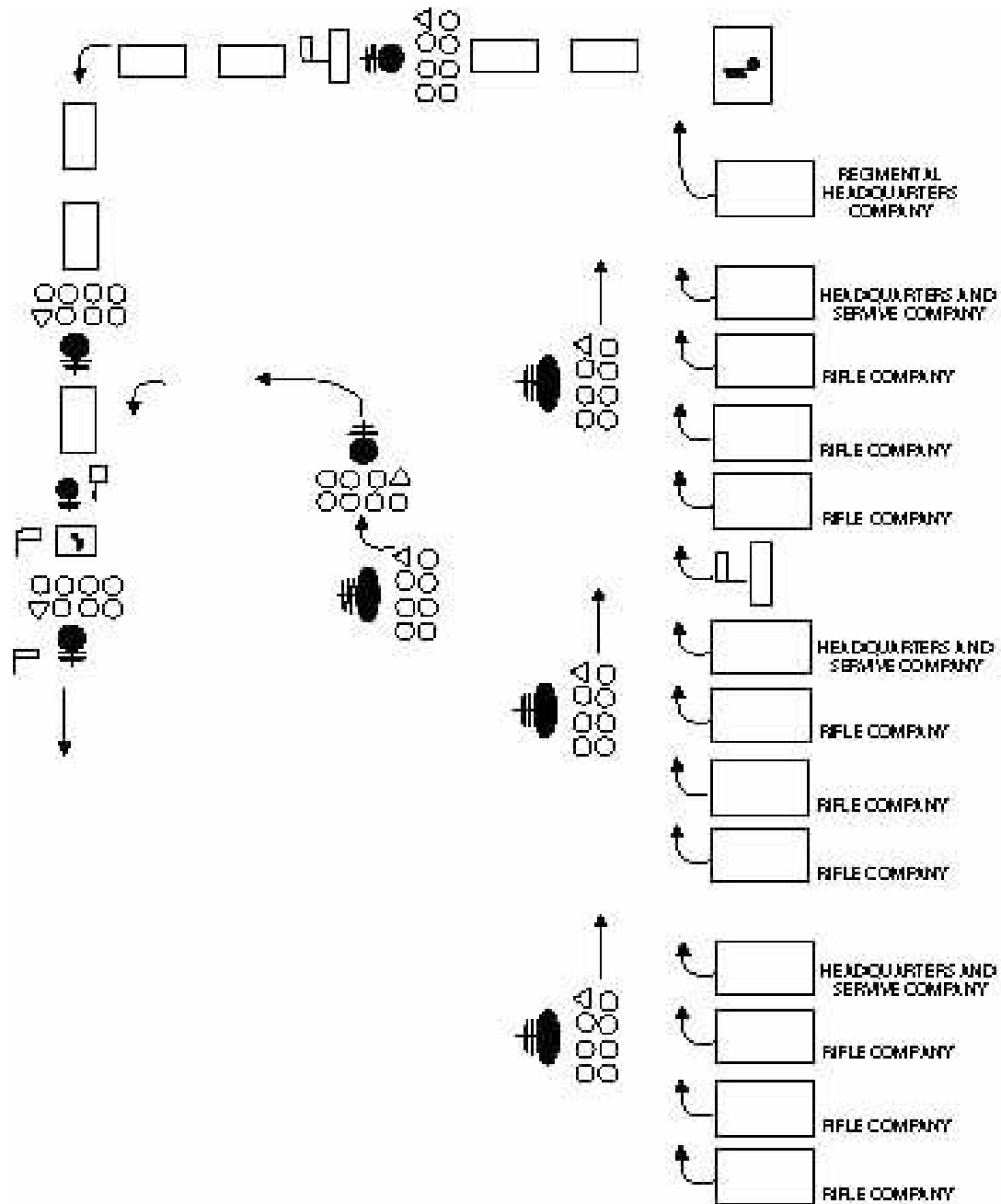

Figure 17-12.--Regimental March in Review.

9. Battalion commanders and their staffs execute eyes right in the same manner as the commander of troops and the staff. Companies march in review in mass formation, column of threes, or column of platoons in line executing changes in direction, flanking movements, and eyes right as appropriate in the same manner as in a battalion parade. After passing in review, only the regimental staff halts near the reviewing area and returns swords. The battalion commanders and their staffs continue to march down the line of march and lead their battalions from the parade field.

17012. BATTALION AND REGIMENTAL FORMATIONS

1. For occasions in which ceremony is desired, but the situation does not provide the opportunity or necessary space for maneuvering units as in a review or a parade, a battalion or regimental ceremonial formation may be conducted. One of several variations may be used according to the situation and type of ceremony desired.

2. One type of battalion (regimental) ceremonial formation is similar to that of a review except that the march in review is omitted. The battalion (regimental) commander acts as the reviewing officer and the executive officer (or other officer so appointed) acts as the commander of troops. Basically, the battalion or regiment forms in line with companies in line or companies in mass formation at "*Adjutant's Call*" for the formation in the same manner as for a review.

- a. For a morning formation including Morning Colors, after the battalion (regiment) is presented to the commander of troops, the commander of troops commands "**SOUND ATTENTION.**" The band sounds "*Attention*". The Commander of troops then commands "**PRESENT ARMS.**" All persons in formation render appropriate salutes. The band then plays the "*National Anthem*" to which the colors are raised while the "*National Anthem*" is played. Immediately following the "*National Anthem*" the band plays "*Carry On.*"
- b. For an evening formation including "*Retreat*", after the battalion (regiment) is presented to the commander of troops, the commander of troops commands "**SOUND ATTENTION.**" The band sounds "*Attention*". The Commander of troops then commands "**PRESENT ARMS.**" All persons in formation render appropriate salutes. The band then plays the "*Retreat*" followed immediately by the "*National Anthem*" to which the colors are lowered while the "*National Anthem*" is played. Immediately following the "*National Anthem*" the band plays "*Carry On.*"
- c. After the command is presented to the commander of troops, if morning/evening colors is not conducted, the commander of troops presents the command to the reviewing officer. If morning/evening colors are part of the ceremony, the commander of troops presents the command to the reviewing officer following the conduct of morning/evening colors.
- d. Presentation of decorations, promotions, retirements, etc., may then be conducted. The commander of troops then dismisses the battalion (regiment). The color guard and color company (battalion) return the colors.

3. Another type of formation is conducted in the same manner as a ceremonial parade, except that the march in review is omitted. The following additional modifications may be made:

- a. The band may "*Sound Off*" in place instead of marching. If evening colors is part of the formation, "*Retreat*" is sounded after the band's second "*Sound Off*," and the adjutant brings the command to attention and to present arms. The flag is lowered while the "*National Anthem*" is played. For a formation at morning colors, the procedure is similar, except after the second "*Sound Off*," the band sounds "*First Call*," then the adjutant brings the command to attention and present arms for the flag to be raised while the "*National Anthem*" is played. After colors, the adjutant may bring the troops to order arms and then dismiss the command, or while troops are still at present arms following colors, the adjutant presents the command to the commander of troops.
- b. The commander of troops presents the command to the battalion (regimental) commander. Then decorations, promotions, retirements, etc., may be presented.

Enclosure (1)

- c. On completion of the ceremony, the command is dismissed. The color guard and color company return the colors.
4. In any of the above ceremonial formations, the battalion (regimental) commander may act as both the commander of troops and the reviewing officer. In this case the following modifications are made:
 - a. The adjutant presents the command to the battalion (regimental) commander after the troops are formed. The presentation normally made to the reviewing officer is omitted.
 - b. During the presentation of decorations, promotions, retirements, etc., the adjutant performs those duties normally required of the commander of troops.

17013. STREET PARADES

1. A person designated as the Grand Marshal commands street parades. The grand marshal appoints a chief of staff and aides, and issues an order concerning the formation, movement and dismissal of the parade. This order includes:
 - a. The names of the staff officers and when and where they are to report to the marshal.
 - b. The assignment of organizations and their order in battalions and larger units, and the names and assignment of battalion commanders and marshals of larger units.
 - c. The streets upon which the battalions and larger units are to form, the direction their lines or columns face, where the right of line or head of column rests, and the width of the fronts of the subdivisions in column.
 - d. The times for each unit to complete it's forming and be ready to march.
 - e. The time and place at, and from, which the head of the parade will move, the line of march and the direction of guide.
 - f. Honors to be paid during the march.
 - g. Instructions for dismissal of the parade.
 - h. Instructions regarding uniform and equipment.
2. The grand marshal may review the parade at some point beyond the reviewing stand before its dismissal.
3. The order of precedence of units in street parades involving two or more services of the United States or of a foreign nation are the same as prescribed in paragraph 15001. Veterans and patriotic organizations parade in the order prescribed by the grand marshal.
4. The grand marshal marches at the head of the parade. The staff, chief of staff on the right, marches 1 1/2 paces to the rear in one or more ranks. Mounted police and a platoon of dismounted police who clear the way usually precede the grand marshal. The marshal of the first unit marches 24 paces to the rear of the staff of the grand marshal.

Enclosure (1)

a. Odd-numbered units are usually formed in streets to the right of the line of march, the first unit nearest the starting point. Even-numbered units are similarly formed on streets to the left of the line of march. Among formations which may be used for street parades are columns of threes (fours) abreast and mass formation. Transportation marches in single column or columns of twos, threes, or fours depending on the width of the street.

b. In long parades, rifles may be carried at sling arms with fixed bayonets.

MARINE CORPS DRILL AND CEREMONIES MANUAL

PART II: CEREMONIES

CHAPTER 18

PRESENTATION OF DECORATIONS AND INDIVIDUAL RETIREMENT

	<u>PARAGRAPH</u>	<u>PAGE</u>
GENERAL	18000	18-3
FORMATION	18001	18-3
SEQUENCE OF EVENTS FOR THE PRESENTATION OF AWARDS	18002	18-4
SEQUENCE OF EVENTS FOR RETIREMENTS	18003	18-8
SEQUENCE OF EVENTS FOR DECORATING UNIT COLORS	18004	18-11
COMBINED CEREMONIES	18005	18-13
BATTLE COLORS CEREMONY	18006	18-15

FIGURE

18-1	POSITIONS OF RETIREES AND AWARD RECIPIENTS.	18-4
18-2	PRECEDENCE OF AWARD RECIPIENTS.	18-5
18-3	COMMANDER OF TROOPS MOVES TO GET COLORS AND AWARD RECIPIENTS.	18-5
18-4	COLORS AND AWARD RECIPIENTS BROUGHT FORWARD	18-6
18-5	POSTING THE COLORS AND AWARD RECIPIENTS	18-8
18-6	RETIREES TAKE THEIR POSTS	18-9
18-7	PRECEDENCE FOR COMBINED AWARDS AND RETIREMENT CEREMONIES.	18-14

MARINE CORPS DRILL AND CEREMONIES MANUAL

PART II: CEREMONIES

CHAPTER 18

PRESENTATION OF DECORATIONS AND INDIVIDUAL RETIREMENT

18000. GENERAL

1. Ceremonies for the presentation of decorations and individual retirement shall be conducted as prescribed in this Chapter. They will include the following:

- a. The presentation of United States decorations.
- b. The decoration of organizational colors.
- c. The presentation of foreign decorations.
- d. The re-dedication of a unit's battle colors.
- e. The retirement of an individual or a group of any rank.

f. Throughout this Chapter, the term "sergeant major" will be used to reflect the actual billet of the unit sergeant major, or the senior enlisted representative present.

2. When practicable, the ceremony set forth below will be held when presenting individual and unit awards and decorations or upon retirement of individuals. The ceremony may be as simple as a formation of the unit affected, a review or a parade depending on the desires of the commander.

18001. FORMATION

1. The command is formed for the appropriate ceremony (e.g., unit formation, parade or review) per this Manual.

2. The color guard is not trooped, but marches on with the formation since the colors are brought forward for the ceremony.

3. Marines, Sailors and other service members receiving awards and decorations are formed as the last rank of the company to the color guard's left and march on with the unit. (See figure 18-1). They fall in according the rank of the decoration to be conferred, the highest ranking decoration on the right.

4. Marines, Sailors and other service members who are retiring sit in the reviewing stand with their families, since this parade is being held in their honor. (See figure 18-1.) When the time comes to effect their retirement, the retirees form to the left of the reviewing stand in a column, from front to rear as listed below, so that they are arranged by seniority, from right to left, when presented to the reviewing officer. They march on when the colors have halted and prior to the commander of troops reporting "**Person(s) to be Retired All Present.**" (See figure 18-5.)

a. Junior retiree, by grade, not receiving an award to senior retiree, by grade, not receiving an award.

b. Junior retiree, by grade, by award, not by rank for award only.

5. The sequence for the presentation of awards, effecting retirements and battle colors re-dedication begins after the commander of troops has presented the command to the unit commander and the command is back at order arms if a parade, or after trooping the line if a review. The commander of troops, having placed the command at attention and order arms, faces the reviewing area. Seeing that the reviewing officer is in position the commander of troops faces the command and begins the sequence of events to present awards per paragraph 18002, effect retirements per paragraph 18003, to decorate unit colors per paragraph 18004, conduct a combined ceremony per paragraph 18005, or re-dedicate a units battle colors per paragraph 18006.

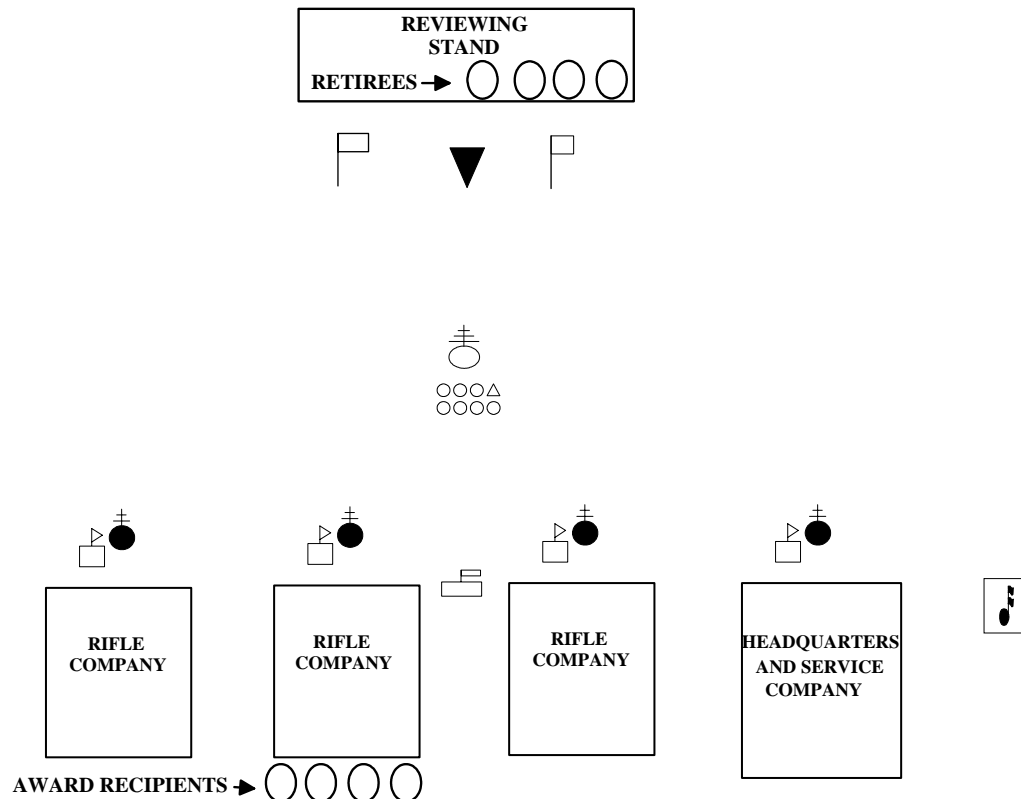

Figure 18-1.--Positions of Retirees and Award Recipients.

18002. SEQUENCE OF EVENTS FOR THE PRESENTATION OF AWARDS

1. Commander of troops commands **"Person(s) to be Decorated and All Colors, Center, MARCH."** On the command **"Colors,"** the color guard goes to carry colors and the staff goes to carry sword.

a. On the command **"Center,"** person(s) to receive awards and the staff execute a right face.

b. On the command **"MARCH,"** the staff steps off and moves forward approximately 8-10 paces, halts, executes a left face and goes to order sword.

c. The award recipients step off and march to a position 5 paces in front of and centered on the colors. (See figure 18-2.)

REVIEWING STANDS

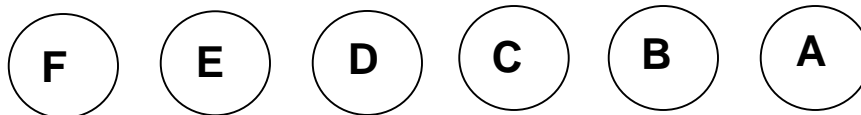

- A. Personal Decoration by order of precedence (senior recipient)
- B. Personal Decoration by order of precedence (junior recipient)
- C. Service Award by order of precedence (senior recipient)
- D. Service Award by order of precedence (junior recipient)
- E. Other Awards by order of precedence (senior recipient)
- F. Other Awards by order of precedence (junior recipient)

Figure 18-2.--Precedence of Award Recipients.

d. The commander of troops, once the staff has cleared, marches forward to the line of award recipients, halts 5 paces in front of them, salutes the colors, and faces about. (See figure 18-3.)

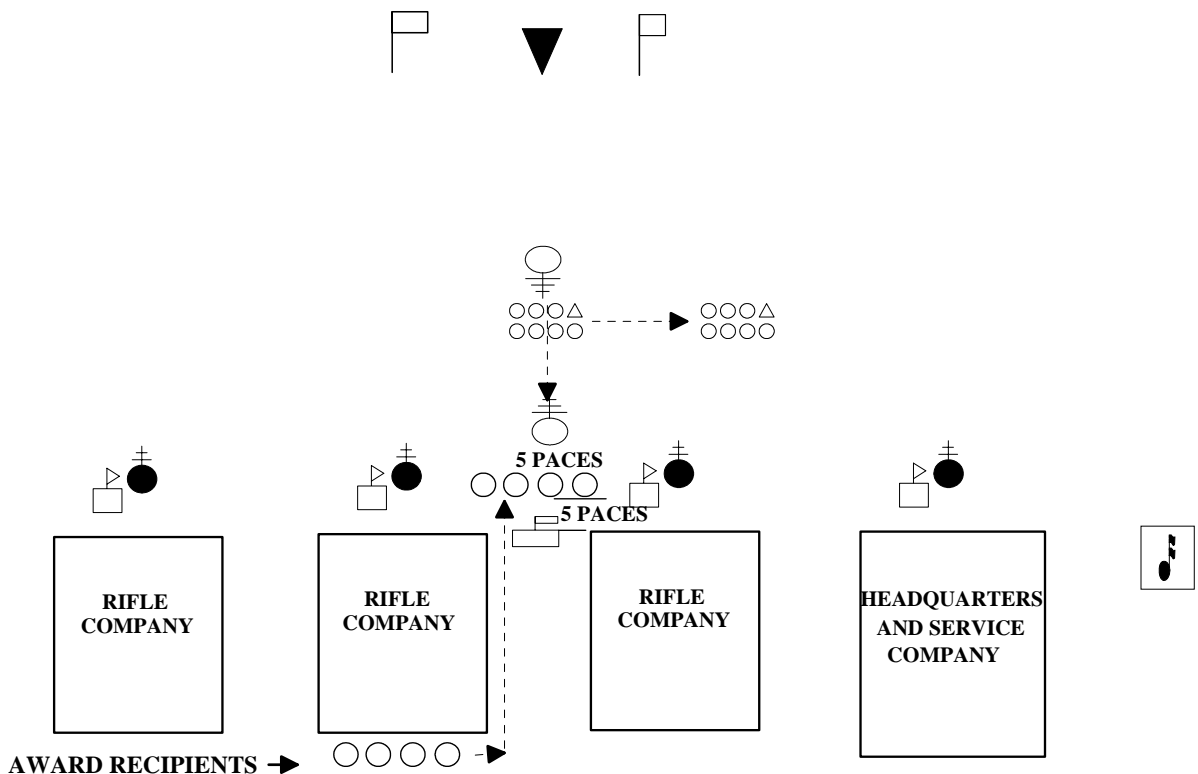

Figure 18-3.--Commander of Troops Moves to Get Colors and Award Recipients.

2. Commander of troops commands **"Forward, MARCH."**

a. The commander of troops, award recipients and color guard march forward towards the reviewing area. The commander of troops commands **"Detachment, HALT"** so that the detail is halted with the commander of troops approximately 10 paces in front of and centered on the reviewing officer. (See figure 18-4.) The color guard remains at the carry.

b. The adjutant commands the staff to carry swords, left face and marches the staff back to its position, where the staff halts, faces the reviewing area and goes to order sword on command of the adjutant. The commander of troops then salutes the reviewing officer and reports, **"Sir/Ma'am, Person(s) to be Decorated and All Colors are Present."** The commander returns the commander of troops' salute.

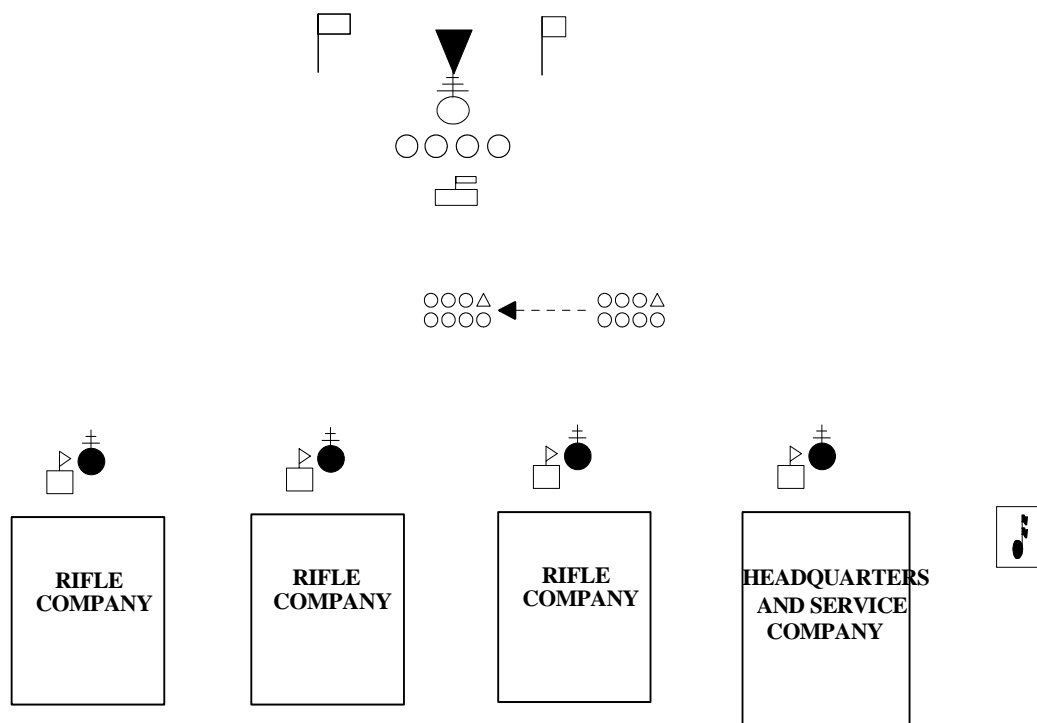

Figure 18-4.--Colors and Award Recipients Brought Forward.

- 3. Reviewing Officer commands **"PRESENT THE COMMAND."** The commander of troops returns to the carry, steps right in marching and moves to a position in front of the staff, saluting the colors as the Marine passes them, halts facing the line of troops.
- 4. Commander of troops commands **"Present, ARMS."** The unit executes. The commander of troops faces the reviewing area.
- 5. Commander of troops then commands **"Staff, Present, ARMS."** The commander of troops and staff execute present sword.

NARRATOR: "LADIES AND GENTLEMEN PLEASE RISE FOR HONORS TO OUR NATIONAL COLORS."

Enclosure (1)

a. The color guard riflemen execute present arms, from the carry upon command of the staff.

→ b. On the first note of the "National Anthem" or "To The Color" the award recipients and reviewing officer executes a hand salute and the organizational color bearer presents colors.

→ c. After the last note of the "National Anthem" or "To The Color" the organizational color bearer returns to the carry position. The award recipients and reviewing officer terminates their salute.

6. Commander of troops commands "**Staff, Order, SWORD.**" The commander of troops, staff, and color guard go to the order. The commander of troops then goes to carry sword and faces the line of troops.

NARRATOR: "LADIES AND GENTLEMEN, PLEASE BE SEATED."

7. Commander of troops commands "**Order, ARMS.**" The unit executes. The commander of troops then faces the reviewing area and goes to order sword.

8. The reviewing officer, assisted by the sergeant major now moves forward and presents the awards. As the reviewing officer arrives in front of each award recipient the narrator reads the award citation and the reviewing officer attaches the medal over the left breast pocket of the recipient.

a. When the medal is attached the reviewing officer and recipient shake hands. Immediately after shaking hands, the award recipient salutes the reviewing officer, who returns the salute.

b. The reviewing officer then moves to the next award recipient by stepping to the left in marching, taking approximately 1 1/2 steps, halts and faces the next recipient.

→ c. After the last award is presented the reviewing officer moves back to the reviewing area and the sergeant major departs the field.

→ 9. Commander of troops commands "**Staff, Carry, SWORD**" and "**POST THE COLORS.**" The commander of troops and staff execute carry swords. The color guard executes carry colors on command from the color sergeant.

10. Commander of troops commands "**Staff, Right, FACE**" and "**Staff, Forward, MARCH.**" The commander of troops and staff execute.

a. Color guard executes a countermarch and moves back to its position in formation, countermarches, halts and goes to order colors. (See figure 18-5.)

→ b. The commander of troops and staff march forward, per paragraph 14003.4, sufficiently for the colors to pass, halts, and executes a left face. When the colors have passed the commander of troops moves the staff back to its position, halts and executes a right face and goes to order sword on command of commander of troops. However, the commander of troops faces the line of troops, remaining at carry sword. When the color guard is in position, and at order colors, the commander of troops faces the reviewing area. (See figure 18-5.)

Enclosure (1)

c. The award recipients march to their position in the reviewing area, and form a line at normal interval, to the left of the reviewing officer. (See figure 18-5.)

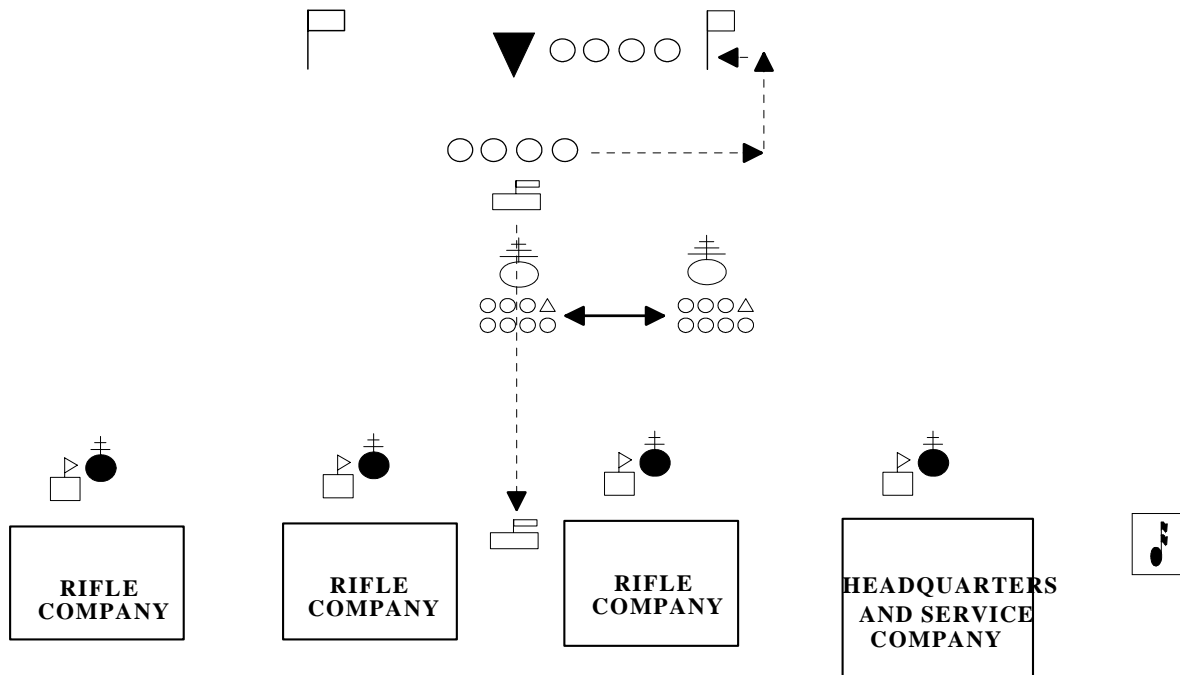

Figure 18-5.--Posting the Colors and Award Recipients.

11. The ceremony would then continue as prescribed for a review (see chapter 16), parade (see chapter 17) or unit formation. (e.g., the command be marched in review, dismissed, etc.)

18003. SEQUENCE OF EVENTS FOR RETIREMENTS

1. After the command has been presented to the reviewing officer, and while the commander of troops is giving the command of **"Order, ARMS,"** the retirees form to the left of the reviewing stand. The retirees form in a single file at twice the normal distance so that they will be extended interval when halted in front of the reviewing officer. This allows space for their spouses to stand at their left. They march on in reverse order. (See figure 18-6.)

2. Commander of troops commands **"Person(s) to be Retired and All Colors, Center, MARCH."** On the command **"Colors,"** the color guard goes to carry colors and the staff goes to carry sword.

a. On the command **"Center,"** the staff executes a right face.

→ b. On the command **"MARCH,"** the staff steps off and moves forward approximately 10 paces, halts, and executes a left face.

c. The commander of troops, once the staff has cleared, marches forward to the color guard, halts 10 paces in front of them, salutes the colors, and faces about.

Enclosure (1)

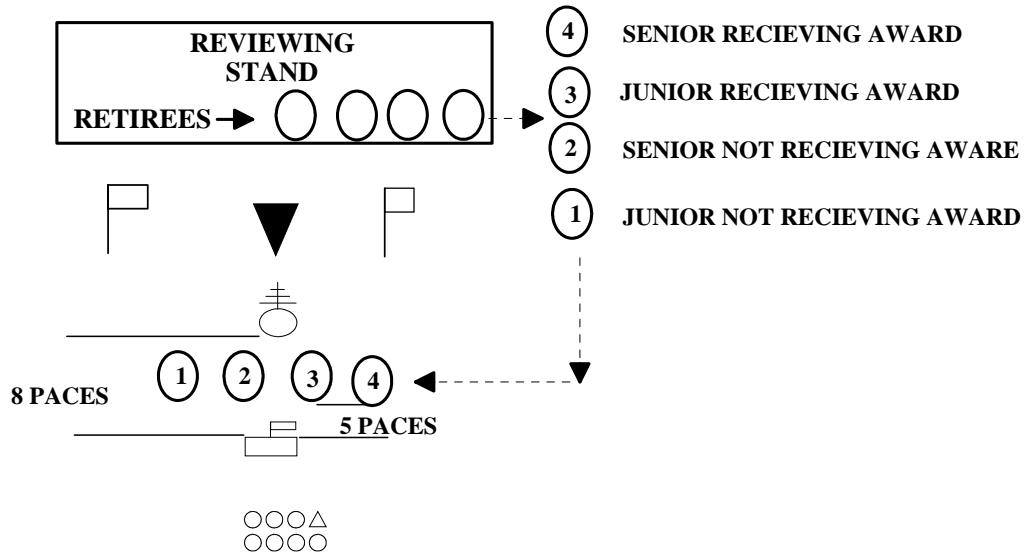

Figure 18-6.--Retirees take Their Posts.

3. Commander of troops commands **"Forward, MARCH."** The commander of troops and color guard march forward towards the reviewing area. The commander of troops commands **"Detachment, HALT"** so that the detail is halted with the commander of troops approximately 10 paces in front of and centered on the reviewing officer. (See figure 18-3.) The color guard remains at the carry.

➔ a. The adjutant commands left face and marches the staff back to its position, where the staff halts, faces the reviewing area and goes to order sword.

b. The retirees march forward, execute a column right, march to a position 5 paces in front of the color guard, halt and execute a right face. They will be at extended interval.

c. The commander of troops, once the retirees are in position, salutes the reviewing officer and reports **"Sir/Ma'am, Person(s) to be Retired and All Colors are Present."** The reviewing officer returns the commander of troops' salute.

➔ 4. Reviewing officer commands **"PRESENT THE COMMAND."** The commander of troops returns to the carry, steps right in marching and moves to a position in front of the staff, saluting the colors as he/she passes them, and halts facing the line of troops.

5. Commander of troops commands **"Present, ARMS."** The unit executes. The commander of troops faces the reviewing area.

➔ 6. Commander of troops then commands **"Staff, Present, ARMS."** The commander of troops and staff execute present sword.

NARRATOR: "LADIES AND GENTLEMEN PLEASE RISE FOR HONORS TO OUR NATIONAL COLORS."

a. The color guard riflemen execute present arms on the command of the staff, from the carry.

Enclosure (1)

- b. On the first note of the "*National Anthem*" or "*To The Color*" the retirees and reviewing officer executes a hand salute and the organizational color bearer presents colors.
 - c. After the last note of the "*National Anthem*" or "*To The Color*" the organizational color bearer returns to the carry position. The retirees and reviewing officer terminates their salute.
7. Commander of troops commands "**Staff, Order, SWORD.**" The commander of troops, staff, and color guard go to the order. The commander of troops then goes to carry sword and faces the line of troops.
8. Commander of troops commands "**Order, ARMS.**" The unit executes. The commander of troops then faces the reviewing area and goes to order sword.

NARRATOR: "LADIES AND GENTLEMEN, PLEASE BE SEATED."

9. The reviewing officer, assisted by the sergeant major now moves forward and presents the awards, if any, and effects the retirements.
- a. As the reviewing officer arrives in front of each retiree the narrator reads the award citation, if any, and the reviewing officer attaches the medal over the left breast pocket of the recipient.
 - b. The narrator then reads extracts from the retirement orders, (e.g., Transferred to the retired list (FMCR) after 20 years of service, Date of retirement, etc.). At this time each retiree is presented a national flag.
 - c. The reviewing officer then moves to the next retiree by stepping to the left in marching, taking approximately 1 1/2 steps, halts and faces the next recipient. After the last retirement has been effected, the reviewing officer moves back to the reviewing area and the sergeant major departs the field. (If spouses are to be recognized the sergeant major will remain and assist the reviewing officer). If spouses are not recognized the reviewing officer followed by the retirees may make remarks.
10. Once the last retirement order is read and if there will be recognition of the spouses and remarks by the reviewing officer and retirees, the commander of troops will come to the carry, face about and order parade rest. The commander of troops will then face about and give the staff parade rest.
11. Marines assigned to do so, now escort the spouses of the retirees to the left of their husband/wife, and stand behind the spouse they escorted.
- a. The narrator then reads the spouses citation (Optional).
 - b. After all spouses have been recognized the Marines assigned as escorts will return the spouses to their seats.
 - c. At this time the reviewing officer moves back to the reviewing area and the sergeant major departs the field. The reviewing officer followed by the retirees may make remarks at this time.
 - d. Once all remarks have been made the reviewing officer returns to the designated position in the reviewing area.

Enclosure (1)

e. The commander of troops, seeing the reviewing officer back in position, comes to attention, and goes to carry sword.

12. Commander of troops commands "**Staff, ATTENTION,**" faces about and commands "**(Size of Unit), ATTENTION.**" Commander of troops faces about and commands "**POST THE COLORS**" and "**Staff, Carry, SWORD.**" The commander of troops and staff execute carry swords. The color guard executes carry colors.

13. Commander of troops commands "**Staff, Right, FACE**" and "**Staff, Forward, MARCH.**" The commander of troops and staff execute.

a. Color guard executes a countermarch and moves back to its position in formation, countermarches, halts and goes to order color. (See figure 18-5.)

b. The commander of troops and staff march forward sufficiently as prescribed in paragraph 14003.4c through 14003.4f for the colors to pass, halts, does a left face and goes to order sword. When the colors have passed the commander of troops moves the staff back to its position, halts and executes a right face and goes to order sword. However, the commander of troops faces the line of troops, remaining at carry sword. When the color guard is in position, and at order colors, the commander of troops faces the reviewing area. (See figure 18-5.)

c. The retirees on command of the commander of troops march to their position in the reviewing area, and form a line at normal interval, to the left of the reviewing officer. (See figure 18-5.)

20. The ceremony would then continue as prescribed for a review (see chapter 16), a parade (see chapter 17) or unit formation. (e.g., the command be marched in review, dismissed, etc.)

18004. SEQUENCE OF EVENTS FOR DECORATING UNIT COLORS

1. Commander of troops commands "**All Colors, Center, MARCH.**" On the command "**Colors,**" the color guard goes to carry colors and the staff goes to carry sword.

a. On the command "**Center,**" the staff executes a right face.

b. On the command "**MARCH,**" the staff steps off and moves forward approximately 8-10 paces, as prescribed in paragraph 14003.4c through 14003.4f, halts, executes a left face and goes to order sword.

c. The colors being decorated step off and march to a position 5 paces in front of and centered on the color guard. (Note: This portion of the movement is only if the units receiving unit awards are subordinate to the parade unit (e.g., battalion colors being decorated at a regimental parade.) If the unit hosting the parade is also the unit receiving the award, then the unit colors remains in the color guard.

d. The commander of troops, once the staff has cleared, marches forward to the line of organizational colors, halts 5 paces in front of them, salutes the colors, and faces about.

2. Commander of troops commands "**Forward, MARCH.**"

a. The commander of troops, award recipients and color guard march forward towards the reviewing area. The commander of troops commands **"Detachment, HALT"** so that the detail is halted with the commander of troops approximately 10 paces in front of and centered on the reviewing officer. (See figure 18-4.) The color guard remains at the carry.

b. The adjutant commands the staff to carry swords, left face and marches the staff back to its position, where the staff halts, faces the reviewing area and goes to order sword. The commander of troops then salutes the reviewing officer and reports, **"Sir/Ma'am, All Colors are Present."** The reviewing officer returns the commander of troops' salute.

3. Reviewing officer commands, **"PRESENT THE COMMAND."** The commander of troops returns to the carry, steps right in marching and moves to a position in front of the staff, saluting the colors as he/she passes them, and halts facing the line of troops.

NARRATOR: "LADIES AND GENTLEMEN PLEASE RISE FOR HONORS TO OUR NATIONAL COLORS."

4. Commander of troops commands **"Present, ARMS."** The unit executes. The commander of troops faces the reviewing area.

5. Commander of troops then commands **"Staff, Present, ARMS."** The commander of troops and staff execute present swords.

a. The color guard riflemen execute present arms on the command of the staff, from the carry.

→ b. On the first note of the "National Anthem" or "To The Color" the reviewing officer executes a hand salute and the organizational color bearer, and colors being decorated, present colors.

→ c. After the last note of the "National Anthem" or "To The Color" the organizational color bearer returns to the carry position. The award recipients and reviewing officer terminates their salute.

6. Commander of troops commands **"Staff, Order, SWORD."** The commander of troops and staff, go to the order. The color guard returns to the carry. The commander of troops then goes to carry sword and faces the line of troops and commands.

7. Commander of troops commands **"Order, ARMS."** The unit executes. The commander of troops then faces the reviewing area and goes to order sword.

NARRATOR: "LADIES AND GENTLEMEN, PLEASE BE SEATED."

8. The reviewing officer, unit commander(s) and sergeant major now move forward to present the awards. As the reviewing officer arrives in front of the colors being decorated the narrator reads the award citation.

a. The organizational color bearer dips the colors forward sufficiently, without the colors touching the ground, to allow the reviewing officer to reach the streamer attachment set. The reviewing officer then attaches the streamer to the colors.

Enclosure (1)

b. The reviewing officer then moves to the next colors by stepping to the left in marching, taking approximately 1 1/2 steps, halts and faces the colors.

c. After the streamer is attached the reviewing officer and unit commander moves back to the reviewing area and the sergeant major departs the field.

d. Remarks if desired are made. If remarks are to be made the commander of troops will place the unit and staff at parade rest. After remarks are completed and the reviewing officer is back in the designated position, the commander of troops will bring the staff and the unit back to attention.

e. If no remarks are made, the commander of troops, seeing the reviewing officer back in position, goes to carry sword.

9. Commander of troops commands "**POST THE COLORS**" and "**Staff, Carry, SWORD.**" The commander of troops and staff execute carry swords.

10. Commander of troops commands "**Staff, Right, FACE**" and "**Staff, Forward, MARCH.**" The commander of troops and staff execute.

a. Color guard executes a countermarch and moves back to its position in formation, countermarches, halts and goes to order colors. (See figure 18-5.)

b. The commander of troops and staff march forward, all on command from the commander of troops, sufficiently for the colors to pass, halts, does a left face and goes to order sword. When the colors have passed the commander of troops moves the staff back to its position, halts and executes a right face and goes to order sword. However, the commander of troops faces the line of troops, remaining at carry sword. When the color guard is in position, and at order colors, the commander of troops faces the reviewing area. (See figure 18-5.)

11. The ceremony would then continue as prescribed for a review (see chapter 16), a parade (see chapter 17) or unit formation. (e.g., the command be marched in review, dismissed, etc.)

18005. COMBINED CEREMONIES

1. On occasion, it will be necessary to combine retirements, awarding personal decorations and unit awards in one ceremony. The ceremony would follow the sequence in paragraph 18002, with the following exceptions.

a. Award recipients and retirees either form behind the company to the left of the color guard, or in the reviewing stand. (See figure 18-1.) If personnel are marching from both locations the unit leader will coordinate in advance how they will march on and position themselves in front of the reviewing officer.

b. In order to bring forward the award recipients and retirees the commander of troops commands "**Person(s) to be Decorated, Retired and All Colors, Center, MARCH.**" When reporting to the reviewing officer the commander reports, "**Sir/Ma'am, Person(s) to be Decorated, Retired and All Colors are Present.**"

c. Spouses of retirees are not brought forward.

d. The formation for the colors receiving awards, person(s) being decorated and retired is depicted in figure 18-7. In those circumstances where an individual is both receiving a decoration and retiring, the Marine would be placed in the line by the precedence of the decoration. In this case the decoration is presented and the retirement is effected prior to moving to the next individual in rank. Use the following precedence for individuals as an example.

- (1) Unit decoration in order of precedence.
- (2) Individual receiving a decoration in order of precedence and retiring.
- (3) Individual receiving a decoration in order of precedence.
- (4) Senior individual retiring with no decoration.
- (5) Junior individual retiring with no decoration.

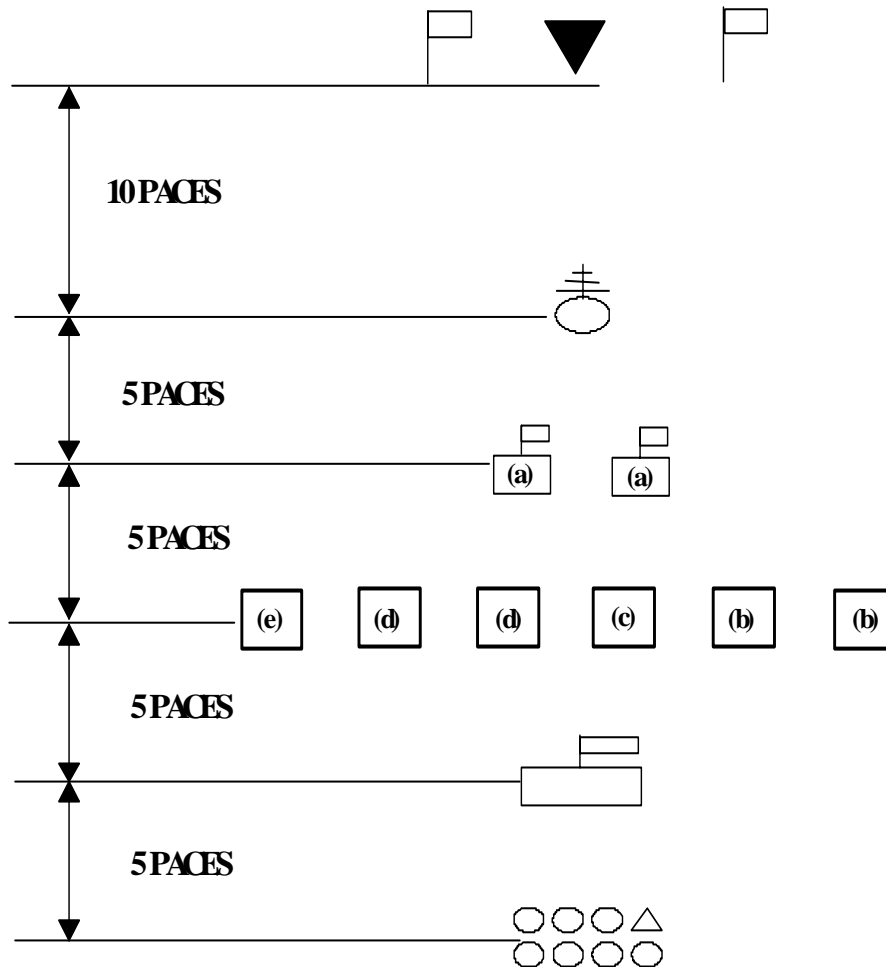

Figure 18-7.--Precedence for Combined Awards and Retirement Ceremonies.

e. The reviewing officer first awards the unit decoration, then the individual decorations and retirements.

f. When posting the colors, the unit colors receiving awards do not march forward until the person(s) receiving individual decorations and retiring have cleared their path. The award recipients and retirees march to their position in the reviewing area, and form a line at normal interval, to the left of the reviewing officer. (See figure 18-5.)

Note: Personnel in key billets who are called forward to receive an award will return to their position in formation once the award recipients have posted to the left of the reviewing officer.

18006. BATTLE COLORS CEREMONY

1. This ceremony follows almost exactly the same sequence used for decorating colors in paragraph 18004. The difference is that it is designed to re-dedicate a unit's organizational colors. This is normally done when celebrating a unit's anniversary or when commemorating a specific battle in which the unit participated.

a. Prior to the start of the ceremony when the colors are being delivered to the color guard the individual streamers designating the units honors are removed from the organizational colors streamer attachment set.

b. Each streamer is given to a designated Marine who will deliver the streamer to the reviewing officer during the presentation portion of the ceremony.

c. Person(s) designated to deliver the streamers will form up in the same manner as retirees per paragraph 18003.1 as shown in figure 18-6. They fall in chronological order of issuance, the oldest streamer presented at the front.

2. Commander of troops commands **"Colors to be Re-dedicated and All Colors, Center, MARCH."**

a. On the command **"Colors,"** the color guard goes to carry colors and the staff goes to carry sword.

b. On the command **"Center,"** the staff executes a right face.

c. On the command **"MARCH,"** the staff steps off and moves forward approximately 10 paces, halts, executes a left face and goes to order sword.

d. The commander of troops, once the staff has cleared, marches forward to the color guard, halts 5 paces in front of them, salutes the colors, and faces about.

3. Commander of troops commands **"Forward, MARCH."**

a. The commander of troops and color guard march forward towards the reviewing area. The commander of troops commands **"Detachment, HALT"** so that the detail is halted with the commander of troops approximately 10 paces in front of and centered on the reviewing officer. The color guard remains at the carry.

b. The adjutant commands the staff to carry sword, left face and marches the staff back to its position, where the staff halts, faces the reviewing area and goes to order sword. The commander of troops then salutes the reviewing officer and reports, "**Sir/Ma'am, Colors to be Re-dedicated and All Colors are Present.**" The reviewing officer returns the commander of troops' salute.

4. Reviewing officer commands, "**PRESENT THE COMMAND.**" The commander of troops returns to the carry, steps right in marching and moves to a position in front of the staff, saluting the colors as he/she passes them, and halts facing the line of troops.

5. Commander of troops commands "**Present, ARMS.**" The unit executes. The commander of troops faces the reviewing area.

NARRATOR: "LADIES AND GENTLEMEN PLEASE RISE FOR HONORS TO OUR NATIONAL COLORS."

6. Commander of troops then commands "**Staff, Present, ARMS.**" The commander of troops and staff execute present sword.

a. The color guard riflemen execute present arms, from the carry.

→ b. On the first note of the "*National Anthem*" or "*To The Color*" the reviewing officer executes a hand salute and the organizational color bearer presents colors.

→ c. After the last note of the "*National Anthem*" or "*To The Color*" the organizational color bearer returns to the carry position. The reviewing officer terminates their salute.

7. Commander of troops commands "**Staff, Order, SWORD.**" The commander of troops, staff, and color guard go to the order. The commander of troops then goes to carry sword, and faces the line of troops.

NARRATOR: "LADIES AND GENTLEMEN, PLEASE BE SEATED."

8. Commander of troops commands "**Order, ARMS.**" The unit executes. The commander of troops then faces the reviewing area and goes to order sword.

9. The reviewing officer assisted by the sergeant major now moves forward to re-attach the streamers. The organizational color bearer dips the colors forward sufficiently, without the colors touching the ground, to allow the reviewing officer to reach the streamer attachment set. The reviewing officer then attaches each streamer to the colors as the narrator reads the citation for the streamer.

a. As the citation for each streamer is read the designated person(s) with that streamer will march forward and present the streamer to the reviewing officer. Once the streamer is attached this person(s) will leave the reviewing area and move behind the reviewing stands.

4. Once all streamers are re-attached the ceremony will proceed in the same manner as those outlined in paragraph 18004.

Enclosure (1)

MARINE CORPS DRILL AND CEREMONIES MANUAL

PART II: CEREMONIES

CHAPTER 19

CHANGE OF COMMAND CEREMONY

	<u>PARAGRAPH</u>	<u>PAGE</u>
GENERAL	19000	19-3
OCCASION	19001	19-3
FORMATION	19002	19-3
SEQUENCE OF EVENTS FOR A CHANGE OF COMMAND WITHOUT PROMOTION, RETIREMENT OR AWARDS	19003	19-3
SEQUENCE OF EVENTS FOR A CHANGE OF COMMAND WITH PROMOTION AND/OR PRESENTATION OF AWARDS	19004	19-6
SEQUENCE OF EVENTS FOR A CHANGE OF COMMAND WITH PRESENTATION OF AWARDS AND/OR RETIREMENT	19005	19-8
HONORS FOR GENERAL OFFICERS AND HIGH RANKING CIVILIANS PARTICIPATING IN THE CHANGE OF COMMAND	19006	19-9

FIGURE

19-1	DELIVERING AND RETURNING THE COLORS.	19-5
------	--	------

MARINE CORPS DRILL AND CEREMONIES MANUAL

PART II: CEREMONIES

CHAPTER 19

CHANGE OF COMMAND CEREMONY

19000. GENERAL. Changes of command in the Marine Corps shall be conducted as prescribed in this Chapter. (The term "sergeant major" will reflect either the unit sergeant major or senior enlisted representative present.)

19001. OCCASION. When practicable, the ceremony set forth below will be held upon the change of command for an organization of battalion or squadron size, or larger units and directors of schools. The ceremony is normally a parade (see chapter 17), however, it may be a review or as simple as a formation of the unit affected.

19002. FORMATION

1. The command is formed for the appropriate ceremony (e.g., unit formation, review or parade) per chapter 16 and 17. When the selected ceremony reaches the point in time when the command is presented to the outgoing commander the sequence of events for the change of command as outlined in this Chapter will be followed.

2. The color guard is normally trooped as part of the sequence of events. However, if the incoming commander is being promoted at the parade or the outgoing commander is retiring or receiving an award during the parade, the color guard marches on with the formation and the colors are brought forward for the promotion/retirement/awards portion of the ceremony.

19003. SEQUENCE OF EVENTS FOR A CHANGE OF COMMAND WITHOUT PROMOTION, RETIREMENT OR AWARDS

1. The standard sequence for a change of command normally begins after the commander of troops has presented the command to the outgoing commander. On occasion, modifications to the normal sequence can take place, such as:

- a. The playing of "Honors," (or)
- b. "Trooping the Line" during a Review.

Note: In these cases, the commander of troops presents the command after completion of the scenarios described above.

2. The commander of troops, having placed the command at attention and order arms, faces the reviewing area. The incoming commander then takes the designated post in the reviewing area to the left and abreast of the outgoing commander. (See figure 19-1.)

3. Commander of troops commands "**Sergeant Major, Deliver the Colors to the Commanding Officer (General).**"

4. The sergeant major, who is positioned to the left of the reviewing stand, moves by the most direct route to the color guard, passing the commander of troops and staff on his/her own right.

a. Upon the commander of troop's command to the sergeant major, the color guard executes carry colors.

b. The sergeant major halts 1 pace in front of and centered on the color guard, and salutes the national colors. Once rendered, the Marine then takes one right step, while at the same time the organizational color bearer removes the organizational colors from the socket. The sergeant major grasps the organizational colors, (left hand at the base near the ferrule, right hand on the staff approximately eye level) and steps off to the right in marching.

c. The color guard remains at carry colors until the organizational colors is returned.

d. The sergeant major then marches to the reviewing area carrying the colors as close to the "carry colors" position as possible without a sling. The sergeant major passes the commander of troops and staff on his/her own right. The sergeant major halts approximately 2 paces in front of the outgoing commander. (See figure 19-1.)

5. Commander of troops commands "**Present, ARMS,**" as the sergeant major is approaching the staff, the commander of troops then faces the reviewing area.

6. Commander of troops commands "**Staff, Present, SWORD.**"

a. The staff executes. At this time the narrator will read the orders of the outgoing commander. The sergeant major then delivers the colors to the outgoing commander (the colors remaining in its most upright position), then executes one right step and salutes.

b. On the sergeant major's salute, the outgoing and incoming commanders face each other. At this time the narrator will read the orders of the incoming commander. The outgoing commander passes the colors to the incoming commander.

c. Both commanders then face front. The sergeant major cuts his/her salute and executes one right step. The incoming commander then returns the colors to the sergeant major.

d. The outgoing and incoming commanders then face each other, exchange salutes and handshakes, and exchange positions (right shoulder to right shoulder).

e. The sergeant major then steps off to the right as in marching and returns the colors to the color guard, passing the staff on his/her right. When arriving at the color guard the sergeant major halts centered on the color guard and returns the organizational colors. The sergeant major salutes steps to the right as in marching and moves by the most direct route from the field, passing the staff on his/her own right. (See figure 19-1.)

7. Commander of troops commands "**Staff, Order, SWORD,**" as the sergeant major is moving to return the organizational colors, the commander of troops and staff execute. The commander of troops faces the line of troops.

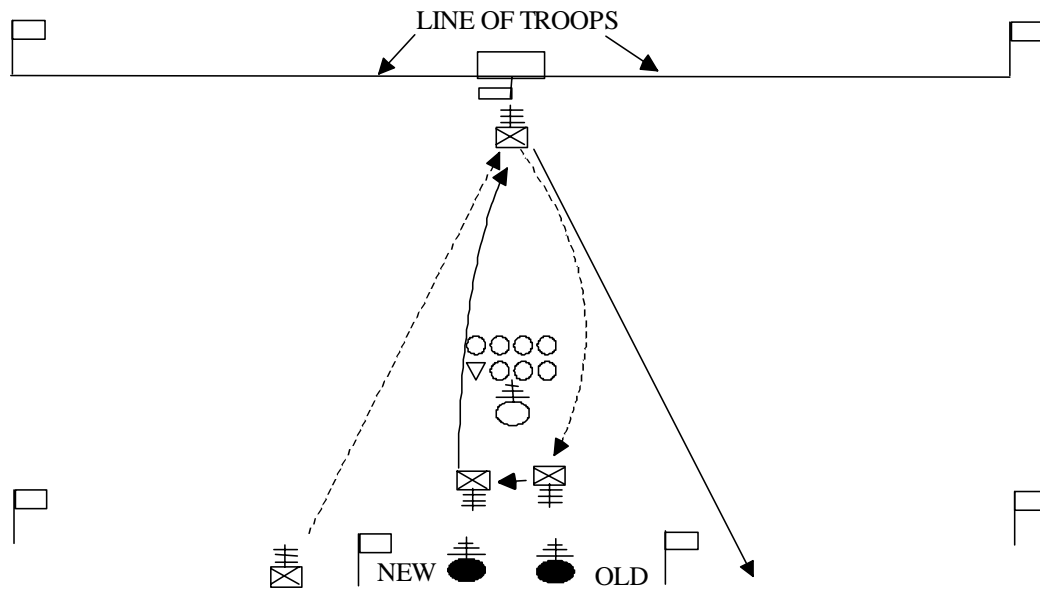

Figure 19-1.--Delivering and Returning the Colors.

8. Commander of troops commands **"Order, ARMS."** The unit executes order arms and/or carry sword.

a. The color guard remains at carry colors and receives the organizational colors from the sergeant major. The color guard then executes order colors. (If honors are to be played as the next sequence, the color guard will remain at carry colors.)

b. After the sergeant major has cleared the parade field the commander of troops will face the line of troops.

Note: If the incoming commander rates honors, continue with paragraph 19003.9. If the incoming commander does not rate honors continue with paragraph 19003.12.

9. Commander of troops commands **"Present, ARMS."** All execute, present arms/present sword.

10. Commander of troops commands (while facing the reviewing area) **"Staff, Present, SWORD."** The staff executes present sword.

NARRATOR: **"LADIES AND GENTLEMEN, PLEASE RISE FOR HONORS TO RANK AND NAME OF COMMANDER."** (The band plays appropriate honors and gun salutes are fired.)

Note: The organizational color bearer salutes on the first note and terminates on the last note (last gun) of honors. After honors are completed the narrator speaks.

NARRATOR: **"LADIES AND GENTLEMEN, PLEASE BE SEATED."**

11. Commander of troops commands **"Staff, Order, SWORD."** The commander of troops and staff execute. The commander of troops goes to carry sword and faces the line of troops.

12. Commander of troops commands **"Order, ARMS"** and **"Parade, REST."** The unit executes. The commander of troops then faces about.

13. Commander of troops commands **"Staff, Parade, REST."**

a. The staff and commander of troops execute.

b. The narrator then delivers a microphone (if available), to the outgoing commander. The commander makes remarks then passes the microphone to the incoming commander who makes his/her remarks. After the incoming commander's remarks the microphone is retrieved. Both commanders return to their positions in the reviewing area assuming the position of attention.

Note: If the reviewing officer or the senior officer present other than the commanders desire to make remarks, they will do so prior to the outgoing and incoming commanders.

14. Commander of troops commands **"Staff, ATTENTION."** The staff and commander of troops execute. The commander of troops goes to carry sword and faces the line of troops.

15. Commander of troops commands **"Battalion/Squadron, ATTENTION."** The unit executes. The commander of troops then faces the reviewing area.

16. Incoming Commander Commands

a. **"DISMISS THE COMMAND"** (or)

b. **"MARCH THE COMMAND IN REVIEW."**

Note: Follow remaining parade sequence for "Dismissing the Command" or "Pass in Review" as explained in chapter 17.

19004. SEQUENCE OF EVENTS FOR A CHANGE OF COMMAND WITH PROMOTION AND/OR PRESENTATION OF AWARDS

1. If the incoming commander is to be promoted as part of the ceremony, the colors are not trooped at the beginning of the parade sequence. The sequence of events begins after the change of command and the command has been presented to the "Promoting/Awarding Official," who is normally senior to both the incoming and outgoing commanders. After honors, if appropriate, (see paragraph 19003.9) are complete the unit is at order arms.

2. Commander of troops commands **"Officer to be Promoted, and All Colors, Center, MARCH."**

a. On the preparatory command **"Colors,"** the staff executes carry sword. On the command **"Center:"**

(1) The staff executes a right face, commander of troops commands **"MARCH,"** the staff marches 8-10 paces, halts, and executes a left face and goes to order sword all on command of the adjutant.

(2) The color guard executes carry colors.

(3) The commander of troops (once the staff has moved), marches to a point, 10 paces in front of the color guard, halts, salutes, and executes an about face.

b. On the command of execution **"MARCH:"**

(1) The commander of troops and the color guard step off and march forward to a point of approximately 10 paces in front of the promoting official. The commander being promoted then takes their position in front of the colors as described for retirees in chapter 18.

(2) As the color guard passes, the staff executes carry sword, left face and returns 8-10 paces to its previous position, executes a right face, and executes order sword all on command of the adjutant. The commander of troops salutes, and reports to the reviewing officer **"Sir/Ma'am, Officer(s) to be Promoted and All Colors are Present."**

3. Promoting official commands **"PRESENT THE COMMAND."** The commander of troops returns to carry sword, faces to the right as in marching, while passing the colors he/she executes present sword and returns to their position in the staff. Facing the line of troops.

4. Commander of troops commands **"Present, ARMS."** (Faces about and commands) **"Staff, Present, SWORD."** (The command is then presented for the *"National Anthem."*) After the last note;

5. After the last note, the commander of troops commands **"Staff, Order, ARMS."** Commander of troops executes carry sword, faces about and commands **"Order, ARMS."**

Note: As an option after the promotion or award is effected the "Promoting Official" may make remarks followed by the old and new commanders. Remarks are made at this time in place of remarks immediately following the passing of the organizational colors. If this option is used the commander of troops will place the command at **"Parade, REST"** until after the remarks then return the command to **"ATTENTION,"** and follow the remainder of the sequence below.

6. After the promotion or award is presented the reviewing officer moves back to the reviewing area and the sergeant major departs the field. The commander of troops, seeing the reviewing officer back in position goes to carry sword.

7. Commander of troops commands **"POST THE COLORS"** and **"Staff, Carry, SWORD."** The commander of troops and staff execute carry sword. The color guard executes carry colors.

8. Commander of troops commands **"Staff, Right, FACE"** and **"Staff, Forward, MARCH."** The commander of troops and staff execute.

a. Color guard executes a countermarch and moves back to its position on line of troops, countermarches, halts and goes to order colors. (See figure 18-4.)

b. The commander of troops and staff march forward sufficiently for the colors to pass, halts, does a left face and goes to order sword. When the colors have passed the commander of troops moves the staff back to its position, halts and

executes a right face and goes to order sword. However, the commander of troops faces the line of troops, remaining at carry sword. When the color guard is in position, and at order colors, the commander of troops faces the reviewing area.

9. Once the promotion or award is effected the outgoing commander takes his/her post in the reviewing area. The change of command then proceeds as described in paragraph 19003.16.

19005. SEQUENCE OF EVENTS FOR A CHANGE OF COMMAND WITH PRESENTATION OF AWARDS AND/OR RETIREMENT

1. If the outgoing commander is to receive an award and/or retire as part of the change of command ceremony, the colors are not trooped at the beginning of the parade ceremony. The sequence of events begins after the change of command and the commander of troops is facing the reviewing area. The "Retiring Official," who is normally senior to both the incoming and outgoing commanders takes his/her post in the reviewing area.

2. Commander of troops commands **"Officer(s) to be Retired, and All Colors, Center, MARCH."**

a. On the preparatory command **"Colors,"** the staff executes carry sword. On the command **"Center:"**

(1) The staff executes a right face, commander of troops commands **"MARCH,"** the staff marches 8-10 paces.

(2) The color guard executes carry colors.

(3) The commander of troops (once the staff has moved), marches to a point, 10 paces in front of the color guard, halts, salutes, and executes an about face.

b. On the command of execution **"MARCH:"**

(1) The commander of troops and the color guard step off and march forward to a point approximately 10 paces in front of the promoting official. The commander being retired then takes their position in front of the colors as described for retirees in chapter 18.

(2) As the color guard passes, the staff returns, as described in paragraph 14003.6, executes carry sword, left face and returns 8-10 paces to its previous position, and executes a right face and executes order sword. The commander of troops salutes, and reports to the reviewing officer **"Sir/Ma'am, All Officers to be Retired and All Colors are Present."**

3. Reviewing officer commands **"PRESENT THE COMMAND."** The commander of troops returns to carry sword, faces to the right as in marching while passing the colors he/she executes present sword and returns to their position in the staff, and facing the line of troops.

4. Commander of troops commands **"Present, ARMS."** (Faces about and commands) **"Staff, Present, SWORD."** (The command is then presented for the *"National Anthem."*)
5. After the last note, the commander of troops commands **"Staff, Order, ARMS."** Commander of troops executes carry sword, faces about and commands **"Order, ARMS."**
6. The award and/or retirement is affected per the procedures in chapter 18.

Note: As an option after the award or retirement is effected the "Retiring Official" may make remarks followed by the old and new commanders. Remarks are made at this time in place of remarks immediately following the passing of the organizational colors. If this option is used the commander of troops will place the command at **"Parade, REST"** until after the remarks then return the command to **"ATTENTION,"** and follow the remainder of the sequence below.

7. After the last award and/or retirement is effected the reviewing officer moves back to the reviewing area. The commander of troops, seeing the reviewing officer back in position, goes to carry sword.
8. Commander of troops commands **"POST THE COLORS"** and **"Staff, Carry, SWORD."** The commander of troops and staff execute carry sword. The color guard executes carry colors.
9. Commander of troops commands **"Staff, Right, FACE"** and **"Staff, Forward, MARCH."** The commander of troops and staff execute.

a. Color guard executes a countermarch and moves back to its position on the line of troops, countermarches, halts and goes to order colors. (See figure 18-4.)

b. The commander of troops and staff march forward sufficiently, as described in paragraph 14003.8b, for the colors to pass, halts, does a left face and goes to order sword. When the colors have passed the commander of troops moves the staff back to its position, halts and executes a right face and goes to order sword. However, the commander of troops faces the line of troops, remaining at carry sword. When the color guard is in position, and at order color, the commander of troops faces the reviewing area.

10. Once colors are returned to the line of troops, the outgoing and incoming commanders take their post in the reviewing area. The command is then marched in review or dismissed.

19006. HONORS FOR GENERAL OFFICERS AND HIGH RANKING CIVILIANS PARTICIPATING IN THE CHANGE OF COMMAND

1. It is not unusual for general officers and high ranking civilians to observe change of command ceremony as invited guests. Unless they are participating in the ceremony as the Promoting/Retiring Official, honors are not rendered since the outgoing and incoming commanders during their remarks recognize them. If participating the following procedures will be used.

a. When the selected ceremony reaches the point in time when the command is presented to the outgoing commander the command is instead presented to the general officer. The narrator would introduce the general officer by announcing.

NARRATOR: "LADIES AND GENTLEMEN, PLEASE RISE FOR HONORS TO _____"
(e.g., The Commanding General, Second Marine Division, Major General Smith).

b. The command is presented and honors are rendered.

NARRATOR: "LADIES AND GENTLEMEN PLEASE BE SEATED."

c. The general officer returns to his/her seat in the reviewing stand.

d. The command is then placed at the order and the commander of troops faces the reviewing area. The outgoing commander then moves to their position in the reviewing area and the change of command resumes its normal sequence.

e. The change of command then proceeds as outlined in paragraph 19003.

MARINE CORPS DRILL AND CEREMONIES MANUAL

PART II: CEREMONIES

CHAPTER 20

RELIEF AND APPOINTMENT OF THE SERGEANT MAJOR

	<u>PARAGRAPH</u>	<u>PAGE</u>
GENERAL	20000	20-3
OCCASION	20001	20-3
FORMATION	20002	20-3
SEQUENCE OF EVENTS FOR THE RELIEF AND APPOINTMENT CEREMONY WITHOUT AN AWARD, PROMOTION OR RETIREMENT	20003	20-3
SEQUENCE OF EVENTS FOR THE RELIEF AND APPOINTMENT CEREMONY WITH A PROMOTION AND/OR PRESENTATION OF AWARDS	20004	20-5
SEQUENCE OF EVENTS FOR THE RELIEF AND APPOINTMENT CEREMONY WITH PRESENTATION OF AWARDS AND/OR RETIREMENT	20005	20-7

FIGURE

20-1	SERGEANTS MAJOR TAKE POSITION	20-4
20-2	POSITION OF THE SERGEANTS MAJOR AFTER RELIEF AND APPOINTMENT	20-5

MARINE CORPS DRILL AND CEREMONIES MANUAL

PART II: CEREMONIES

CHAPTER 20

RELIEF AND APPOINTMENT OF THE SERGEANT MAJOR

20000. GENERAL. Ceremonies for relief and appointment of sergeants major in the Marine Corps shall be conducted as prescribed in this Chapter.

20001. OCCASION. When practicable, the ceremony set forth below will be held upon the relief of the old and appointment of the new sergeant major within units of battalion or squadron size and larger. The ceremony may be as simple as a formation of the unit affected a review or a parade. For example, if the old sergeant major is transferring then a formation or review is appropriate. If the old sergeant major is retiring then a retirement parade in conjunction with the relief and appointment ceremony is appropriate.

20002. FORMATION

1. The command is formed for the appropriate ceremony (e.g., unit formation, parade or review) per chapters 11, 12, 16 and/or 17.

2. If no award, promotion or retirement is effected as part of the ceremony then the colors will be trooped.

20003. SEQUENCE OF EVENTS FOR THE RELIEF AND APPOINTMENT CEREMONY WITHOUT AN AWARD, PROMOTION OR RETIREMENT

1. The sequence for the relief and appointment of the sergeants major begins after the commander of troops has presented the command to the unit commander and the command is back at order arms if a parade, or after trooping the line if a review.

2. Commander of troops commands **"Sergeants Major, Front and Center, MARCH."**

→ 3. The sergeants major moves from their seats in the reviewing stand to positions five paces in front of the reviewing area, the old sergeant major on the right. (See figure 20-1.) The old sergeant major will carry the sword of office in the unrigged carry position under the left arm as prescribed in figure 5-18.

Note: The old and new sergeants major will only exchange a noncommissioned officer's sword. The exchange of k-bar knives, swagger sticks, or any other form of symbolism, is expressly forbidden.

NARRATOR: SINCE 1875 NONCOMMISSIONED AND STAFF NONCOMMISSIONED OFFICERS HAVE CARRIED THE NONCOMMISSIONED OFFICER SWORD AS A SYMBOL OF THEIR ABILITY AND PRESTIGE AS ENLISTED LEADERS OF THE MARINE CORPS. THE SERGEANT MAJOR AS THE SENIOR ENLISTED LEADER AND ADVISOR IS THE KEEPER OF TRADITIONS FOR HIS/HER UNIT. TODAYS EMBLEMATIC PASSING OF THE SWORD OF OFFICE SIGNIFIES THE TRANSFER OF THIS SACRED TRUST FROM ONE SERGEANT MAJOR TO ANOTHER.

Enclosure (1)

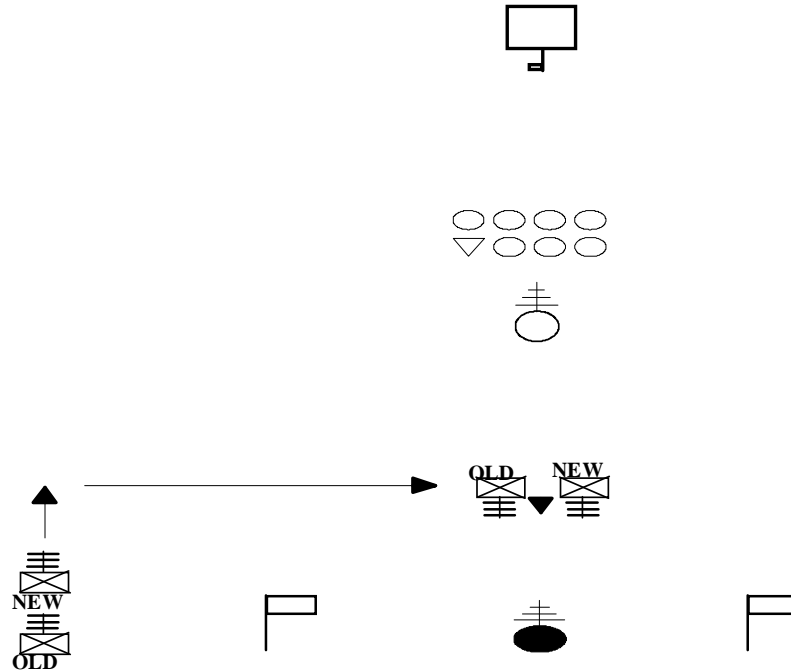

Figure 20-1.--Sergeants Major take Position.

4. Relief and Appointment

➔ **NARRATOR: READS THE ORDERS FOR THE OUTGOING SERGEANT MAJOR.**

- ➔ a. The old sergeant major then steps front and center of the unit commander, salute and reports **"Sir/Ma'am, Sergeant Major _____ reporting as the old sergeant major."** The unit commander returns the salute and states **"You are relieved."** The old sergeant major then yields the responsibility of his/her post by surrendering the sword of office to the unit commander, who places it at unrigged carry. The old sergeant major then moves to his/her new position approximately 3 paces to the left and abreast of the unit commander. (See figure 20-2.)

NARRATOR: READS THE ORDERS FOR THE INCOMING SERGEANT MAJOR.

- b. The new sergeant major then steps front and center of the unit commander, salutes and reports **"Sir/Ma'am, Sergeant Major _____ reporting as the new sergeant major."** The unit commander returns the salute and passes the sword to the new sergeant major, who assumes the unrigged carry. The unit commander then states **"TAKE YOUR POST."** The new sergeant major then moves to his/her position between the unit commander and old sergeant major. The staff noncommissioned officer/noncommissioned officer designated to retrieve the sword then moves behind the new sergeant major, takes the sword, places it at the unrigged carry and marches from the field. (See figure 20-2.)

5. Commander of troops commands **"Parade, REST."** The command executes parade rest. The commander of troops then faces the reviewing area.

6. Commander of troops commands **"Staff, Parade, REST."** The commander of troops, staff, color guard, unit commander and sergeants major execute parade rest. The

Enclosure (1)

microphone is delivered to the unit commander who makes their remarks. The microphone is then passed to the old sergeant major for remarks and then the new sergeant major for remarks. Once all remarks are completed the microphone is retrieved.

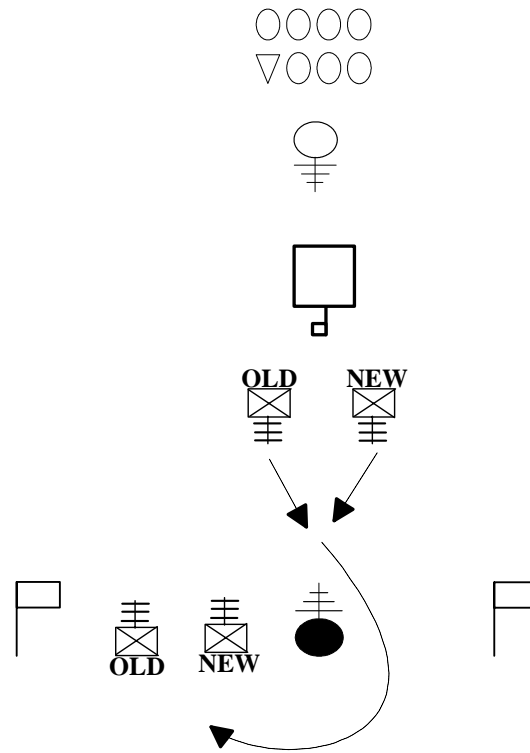

Figure 20-2.--Position of the Sergeants Major after Relief and Appointment.

7. Commander of troops commands "**Staff, ATTENTION.**" The commander of troops, staff, color guard, unit commander and sergeants major execute attention. The commander of troops then faces the line of troops.
8. Commander of troops commands "**Battalion, ATTENTION.**" The battalion executes attention. The commander of troops then faces the reviewing area.
9. The ceremony would then continue as prescribe for a review (see chapter 16), a parade (see chapter 17) or unit formation (e.g., the command is marched in review, dismissed, etc.).

20004. SEQUENCE OF EVENTS FOR THE RELIEF AND APPOINTMENT CEREMONY WITH A PROMOTION AND/OR PRESENTATION OF AWARDS

1. If the incoming sergeant major is to be promoted as part of the ceremony, the colors are not trooped at the beginning of the parade sequence. The sequence of events begins after the change of command and the command has been presented to the "Promoting Official." After honors, if appropriate, are complete the unit is at order arms.

2. Commander of troops commands **"Personnel to be Promoted, and All Colors, Center, MARCH."**

a. On the preparatory command **"Colors,"** the staff executes carry sword. On the command **"Center:"**

(1) The staff executes a right face, commander of troops commands **"MARCH,"** the staff marches, as described in paragraph 14003.c through 14003.f, 8-10 paces, halts, and executes a left face and goes to order sword.

(2) The color guard executes carry colors.

(3) The commander of troops (once the staff has moved), marches to a point, 10 paces in front of the color guard, halts, salutes, and executes an about face.

b. On the command of execution **"March:"**

(1) The commander of troops and the color guard step off and march forward to a point of approximately 10 paces in front of the promoting official. The person being promoted then takes his/her position in front of the colors as described for retirees in chapter 18.

(2) As the color guard passes, the staff returns to its position, as described in paragraph 14006, executes carry sword, left face and returns 8-10 paces to its previous position, returns to its position as described in paragraph 14006 executes a right face, and executes order sword. The commander of troops salutes, and reports to the reviewing officer **"Sir/Ma'am, Personnel to be Promoted and All Colors are Present."**

3. Promoting official commands, **"PRESENT THE COMMAND."** The commander of troops returns to carry sword, faces to the right as in marching, while passing the colors he/she executes present sword, returns to their position in the staff, and faces the line of troops.

4. Commander of troops commands **"Present, ARMS."** (Faces about and commands) **"Staff, Present, SWORD."** (The command is then presented for the "National Anthem.")

→ 5. After the last note, the commander of troops commands **"Staff, Order, ARMS."** Commander of troops executes carry sword, faces about and commands **"Order, ARMS."**

Note: As an option after the promotion or award is effected the "Promoting Official" may make remarks followed by the old and new sergeants major. Remarks are made at this time in place of remarks immediately following the passing of the sword of office. If this option is used the commander of troops will place the command at **"Parade, REST"** until after the remarks then return the command to **"ATTENTION,"** and follow the remainder of the sequence below.

6. After the promotion or award is presented the reviewing officer moves back to the reviewing area and the sergeants major post to the reviewing officers left. The commander of troops, seeing the reviewing officer back in position goes to carry sword.

7. Commander of troops commands **"POST THE COLORS"** and **"Staff, Carry, SWORD."** The commander of troops and staff execute carry swords. The color guard executes carry colors.

Enclosure

8. Commander of troops commands **"Staff, Right, FACE"** and **"Staff, Forward, MARCH."** The commander of troops and staff execute.

a. Color guard executes a countermarch and moves back to its position on line of troops, countermarches, halts and goes to order colors. (See figure 18-4.)

b. The commander of troops and staff march, as described in paragraph 14008, forward sufficiently for the colors to pass, halts, does a left face and goes to order sword. When the colors have passed the commander of troops moves the staff back to its position, halts and executes a right face and goes to order sword. However, the commander of troops faces the line of troops, remaining at carry sword. When the color guard is in position, and at order colors, the commander of troops faces the reviewing area.

9. The ceremony would then continue as prescribe for a review (see chapter 16), a parade (see chapter 17) or unit formation (e.g., the command is marched in review, dismissed, etc.).

20005. SEQUENCE OF EVENTS FOR THE RELIEF AND APPOINTMENT CEREMONY WITH PRESENTATION OF AWARDS AND/OR RETIREMENT

1. If the outgoing sergeant major is to receive an award and/or retire as part of the change of command ceremony, the colors are not trooped at the beginning of the parade ceremony. The sequence of events begins after the relief and appointment and the commander of troops is facing the reviewing area in paragraph 20004.2. The "Retiring Official," takes his/her post in the reviewing area.

2. Commander of troops commands **"Personnel to be Retired, and All Colors, Center."**

a. On the preparatory command **"Colors,"** the staff executes carry sword. On the command **"Center:"**

(1) The staff executes a right face, commander of troops commands **"MARCH,"** the staff marches 8-10 paces, halts, and executes a left face and goes to order sword.

(2) The color guard executes carry colors.

(3) The commander of troops (once the staff has moved), marches to a point, 10 paces in front of the color guard, halts, salutes, and executes an about face.

b. On the command of execution **"MARCH:"**

(1) The commander of troops and the color guard step off and march forward to a point approximately 10 paces in front of the retiring official. The sergeant major being retired then takes his/her position in front of the colors as described for retirees in chapter 18.

(2) As the color guard passes, the staff executes carry sword, left face and returns 8-10 paces, as described in paragraph 14003.c through 14003.f, to its previous position, and executes a right face and executes order sword. The commander of troops salutes, and reports to the reviewing officer **"Sir/Ma'am, Personnel to be Retired and All Colors are Present."**

3. Reviewing officer commands, "**PRESENT THE COMMAND.**" The commander of troops returns to carry sword, faces to the right as in marching, while passing the colors he/she executes present sword, returns to his/her position in the staff, and faces the line of troops.

4. Commander of troops commands "**Present, ARMS.**" (Faces about and commands.) "**Staff, Present, SWORD.**" (The command is then presented for the "*National Anthem.*")

5. After the last note, the commander of troops commands "**Staff, Order, ARMS.**" Commander of troops executes carry sword, faces about and commands "**Order, ARMS.**"

→ 6. The award and/or retirement is effected per the procedures in chapter 18.

Note: As an option the new sergeant major may make his/her remarks immediately following the post and relief. After the award or retirement is effected the "Retiring Official" may make remarks followed by the old sergeant major. This allows the old sergeant major the option of speaking last during his/her retirement ceremony. If this option is used the commander of troops will place the command at "**Parade, REST**" until after the remarks then return the command to "**ATTENTION,**" and follow the remainder of the sequence below.

7. After the last award and/or retirement is effected the reviewing officer moves back to the reviewing area, the sergeants major post to his/her left and the commander of troops, seeing the reviewing officer back in position, goes to carry sword.

8. Commander of troops command "**POST THE COLORS**" and "**Staff, Carry, SWORD.**" The commander of troops and staff execute carry sword. The color guard executes carry colors.

9. Commander of troops commands "**Staff, Right, FACE**" and "**Staff, Forward, MARCH.**" The commander of troops and staff execute.

a. Color guard executes a countermarch and moves back to its position on the line of troops, countermarches, halts and goes to order colors. (See figure 18-4.)

b. The commander of troops and staff march forward, as described in paragraph 14008, sufficiently for the colors to pass, halts, does a left face and goes to order sword. When the colors have passed the commander of troops moves the staff back to its position, halts and executes a right face and goes to order sword. However, the commander of troops faces the line of troops, remaining at carry sword. When the color guard is in position, and at order colors, the commander of troops faces the reviewing area.

10. Once colors are returned to the line of troops, the old and new sergeants major take their post in the reviewing area. The command is then marched in review or dismissed.

11. The ceremony would then continue as prescribe for a review (see chapter 16), a parade (see chapter 17) or unit formation (e.g., the command is marched in review, dismissed, etc.).

Enclosure (1)

MARINE CORPS DRILL AND CEREMONIES MANUAL

PART II: CEREMONIES

CHAPTER 21

ACTIVATION AND DEACTIVATION CEREMONY

	<u>PARAGRAPH</u>	<u>PAGE</u>
GENERAL	21000	21-3
ACTIVATION OF AN ORGANIZATION	21001	21-3
DEACTIVATION OF AN ORGANIZATION	21002	21-4
JOINT DEACTIVATION AND ACTIVATION CEREMONY	21003	21-6

FIGURE

21-1	RETIRE THE GUIDONS	21-5
21-2	COLORS CENTER.	21-8
21-3	POST THE GUIDONS	21-9

MARINE CORPS DRILL AND CEREMONIES MANUAL

PART II: CEREMONIES

CHAPTER 21

ACTIVATION AND DEACTIVATION CEREMONY

21000. GENERAL. On the occasion that Marine Corps organizations of battalion or squadron size and larger are activated or deactivated, the ceremonies in this Chapter will be used as guidelines. The term sergeant major refers to either the unit level sergeant major or the senior enlisted representative of the unit.

21001. ACTIVATION OF AN ORGANIZATION

1. The preferred ceremony for the activation of an organization is a parade. The troops are marched on as described in chapter 17.
2. The colors march on with the command and the national and organizational colors cased.
3. After presenting the command to the commander or officer activating the unit, the command is returned to the order.
4. Commander of troops commands **"All Colors, Center, MARCH."**

a. The commander of troops moves to bring the colors forward as described in paragraphs 18004.1 and 18004.2. When the colors are forward, the commander of troops salutes the commander and reports **"Sir/Ma'am, (Units designation) Colors are Present."**

b. The commander or officer activating the unit and sergeant major move forward to the color guard. As they approach the color guard the national and organizational color bearers take the colors from the sling and lowers them sufficiently for the commander, assisted by the sergeant major, to uncase the national and organizational colors. As the colors are uncased;

NARRATOR READS PERTINENT EXTRACTS FROM THE ORDERS ACTIVATING THE UNIT.

c. After the colors are uncased the color bearers returns them to the carry. The commander returns to his/her post and the sergeant major departs from the field.

5. Commander commands **"POST THE GUIDONS."** The guidon bearers march to a position in front of their respective company commanders. The company commanders will unfurl the guidons and the guidon bearers will return to their normal position 1 pace to the left and back of the company commanders.

Note: The company guidon bearers will begin the ceremonies and up to this point with their guidons furled.

6. Commander commands, **"PRESENT THE COMMAND."** The commander of troops conducts present the command as outlined in paragraph 18004.3.

a. Band plays *"National Anthem."*

b. After the command is presented and brought back to the order it is placed at parade rest and the commander or other officials deliver remarks.

c. After all remarks are completed, the command is brought to attention, the colors are posted and a march in review as described in chapter 17 conducted.

21002. DEACTIVATION OF AN ORGANIZATION

1. The preferred ceremony for the deactivation of an organization is a review. The troops are unarmed and formed prior to the review as described in paragraph 16006. During the review no awards are issued and the colors are not brought forward. While the line is being trooped the narrator would read the lineage, honors and brief history of the unit. After the commander has finished trooping the line, and the command is back at attention, the commander directs the commander of troops to "**MARCH THE COMMAND IN FINAL REVIEW.**" The command marches in review as described in chapter 17, however, after marching in review the command reforms on the line of troops. After the unit has reformed, the band, commander of troops and staff are returned to their original position.

2. Commander of troops commands "**All Colors, Center, MARCH.**" The commander of troops moves to bring the colors forward as described in paragraphs 18004.1 and 18004.2. When the colors are forward, the commander of troops salutes the commander and reports "**Sir/Ma'am, (Units designation) Colors are Present.**"

3. Commander commands, "**PRESENT THE COMMAND.**" The commander of troops moves to present the command as outlined in paragraph 18004.3.

a. Band plays "*National Anthem.*"

b. After the command is presented, brought back to the order and placed at parade rest, the commander or other officials deliver remarks.

4. After all remarks are completed the command is brought back to attention. The commander of troops then directs that the company/battery guidons be retired by commanding "**Retire, GUIDONS.**" (See figure 21-1.) On this command unit first sergeants move from their position in the formation by the most direct route and to a position 1 pace in front of and facing the guidon bearer. The guidon is passed to the first sergeant. After receiving the guidon the first sergeants face about and march by the most direct route to their designated position on either side of the reviewing area where guidon stands have been staged. They halt together, place the guidons in the stands, face about and return to their position in the formation.

5. Once the first sergeants have returned to their position in the formation the color guard goes to the carry. The commander and sergeant major move forward to the color guard. As they approach the color guard the national and organizational color bearers take the colors from the slings and lower them sufficiently for the commander assisted by the sergeant major, to case the national and organization's colors. As the colors are being cased;

**NARRATOR READS PERTINENT EXTRACTS FROM THE ORDERS DEACTIVATING THE ORGANIZATION.
(REFER TO UNITS MCBUL 5400 SERIES.)**

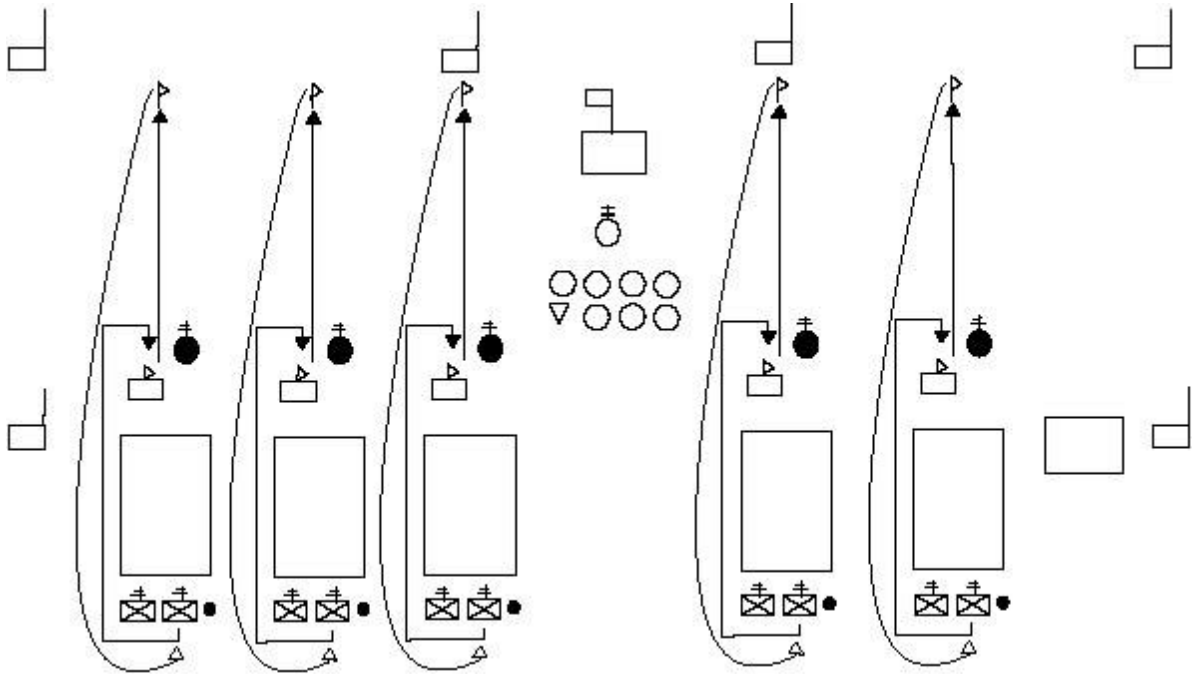

Figure 21-1.--Retire the Guidons.

6. When the colors are cased the national and organizational color bearer returns to the carry and the commander and sergeant major return to their posts.
7. Commander commands "**RETIRE THE COLORS.**" The color guard executes a countermarch and halts facing the line of troops.
 - a. The commander of troops then presents the command.
 - b. The color guard executes a right turn and marches from the field while the band plays martial music.
 - c. After the color guard has cleared the field the commander of troops brings the command to the order and faces the commander.
8. Commander commands "**DISMISS THE BATTALION.**"
9. The commander of troops and commander exchange salutes. The commander of troops then faces the line of troops and orders the company commanders to dismiss their companies. Salutes are exchanged between the company commanders and commander of troops. The commander of troops then dismisses the staff and the company commanders dismiss their companies, in sequence, from right to left.
10. The band plays "*Auld Lang Syne*" and retires from the field.
11. The narrator announces the end of the ceremony.

21003. JOINT DEACTIVATION AND ACTIVATION CEREMONY

1. On the occasion when two Marine Corps organizations of battalion or squadron size and larger are merged in to one larger organization, the ceremony in this Chapter will be used as a guideline.
2. The preferred ceremony for the activation of an organization is a parade. The troops are marched on as described in chapter 17 for a regimental parade.
3. The next higher headquarters of both merging units will conduct the parade and will normally be done using the procedures for a regimental formation as described in chapter 17.
4. The colors of the next higher unit will be used for the ceremony with those of the merging units uncased and massed behind the color guard per the procedures in chapter 7. The colors of the new unit to be formed by the merger will be cased and centered between the retiring colors in the mass colors formation. The colors will march on with the command.
5. The parade will be conducted as prescribed in chapter 17 up to the and including the presentation of the command and honors. After honors the commander of troops commands. **"All Colors, Center, MARCH."** On the command **"Colors,"** the color guard goes to carry colors and the staff goes to carry sword.
 - a. On the command **"Center,"** the staff executes a right face.
 - b. On the command **"MARCH,"** the staff steps off and moves forward 8-10 paces, halts, executes a left face and goes to order sword.
 - c. The colors being retired and the colors of the new unit step off and march to a position 5 paces in front of and centered on the color guard.
 - d. The commander of troops, once the staff has clear, marches forward to the line of organizational colors, halts 5 paces in front of them, salutes the colors, and faces about.
6. Commander of troops commands **"Forward, MARCH."**
 - a. The commander of troops, colors to be retired and uncased, and the color guard march forward towards the reviewing area. The commander of troops commands **"Detachment, HALT"** so that the detail is halted with the commander of troops 5 paces in front of and centered on the reviewing officer. (See figure 18-4.) The color guard remains at the carry. (See figure 21-2.)
 - b. The adjutant commands the staff to carry sword, left face and marches the staff back to its position, where the staff halts, faces the reviewing area and goes to order sword. The commander of troops then salutes the reviewing officer and reports **"Sir/Ma'am, all Colors are Present."** The commander returns the commander of troops' salute.
7. Commander commands, **"PRESENT THE COMMAND."** The commander of troops moves to present the command as outlined in paragraph 18004.3.
 - a. Band plays *"National Anthem."*

b. After the command is presented, brought back to the order and placed at parade rest, the commander of troops commands **"Retire, GUIDONS."** (See figure 21-1.)

c. On this command unit first sergeants move from their position in the formation by the most direct route and to a position 1 pace in front of and facing the guidon bearer. The guidon is passed to the first sergeant. After receiving the guidon the first sergeants faces about and march by the most direct route to their designated position on either side of the reviewing area where guidon stands have been staged. They halt together, place the guidons in the stands, face about and remain at their position in front of the guidons (except the first sergeant of the Headquarters and Service Company of the left battalion who will return to his/her normal position in the formation.)

Note: These will be double guidon stands with an empty side (left) for the retired guidon and the guidon for the newly activated unit pre-staged on the right. The guidon for the newly activated unit will be furled.)

8. At this time simultaneously, the organizational colors of the merging units will be retired.

a. The commanders from both deactivating units will step forward and assisted by the sergeant major will case their organizational colors. As they approach the color guard the organizational color bearer takes the colors from the sling and lowers it sufficiently for the commander, assisted by the sergeant major, to case the organization's colors. As the colors are cased; **NARRATOR READS PERTINENT EXTRACTS FROM THE ORDERS DEACTIVATING THE UNITS.**

b. The band plays "*Auld Lang Syne*" as the colors are cased.

c. After the colors are cased the color bearer returns them to the carry and then passes the colors to the sergeant major. The sergeants major march from the field with the cased colors followed by the color bearer. The commanders return to their post.

9. Once the colors are cased the unit may be placed at parade rest and remarks made by the reviewing officer and/or the commanding officers of the two units that have been deactivated. Following remarks the old commanders return to their seats. After these remarks the unit is brought back to attention.

10. The commander or officer activating the unit and sergeant major move forward to the color guard. As they approach the color guard the organizational color bearer takes the cased colors from the sling and lowers it sufficiently for the commander, assisted by the sergeant major, to uncase the organization's colors. As the colors are uncased;

NARRATOR READS PERTINENT EXTRACTS FROM THE ORDERS ACTIVATING THE UNIT.

After the new organizational color is uncased the color bearer returns it to the carry. The commander returns to his/her post and the sergeant major departs from the field.

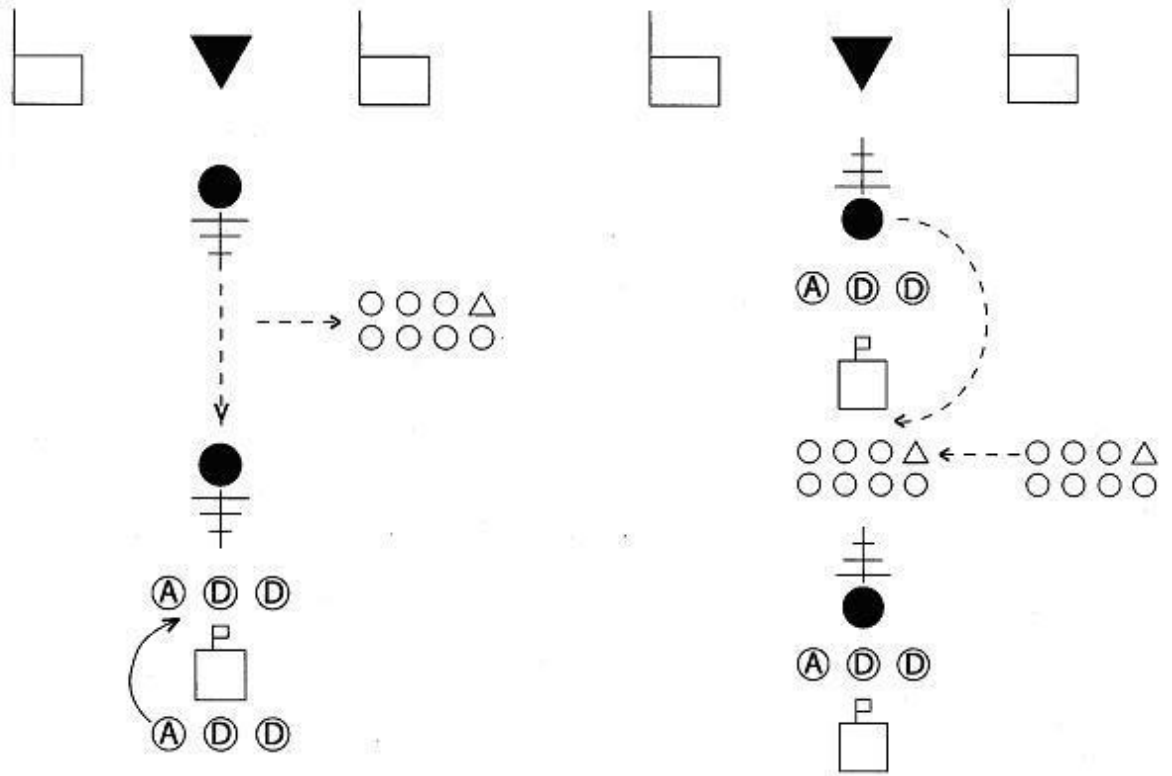

Step 1 - Colors Brought Forward

Step 2 - COT and Staff Re-center, Present the Command

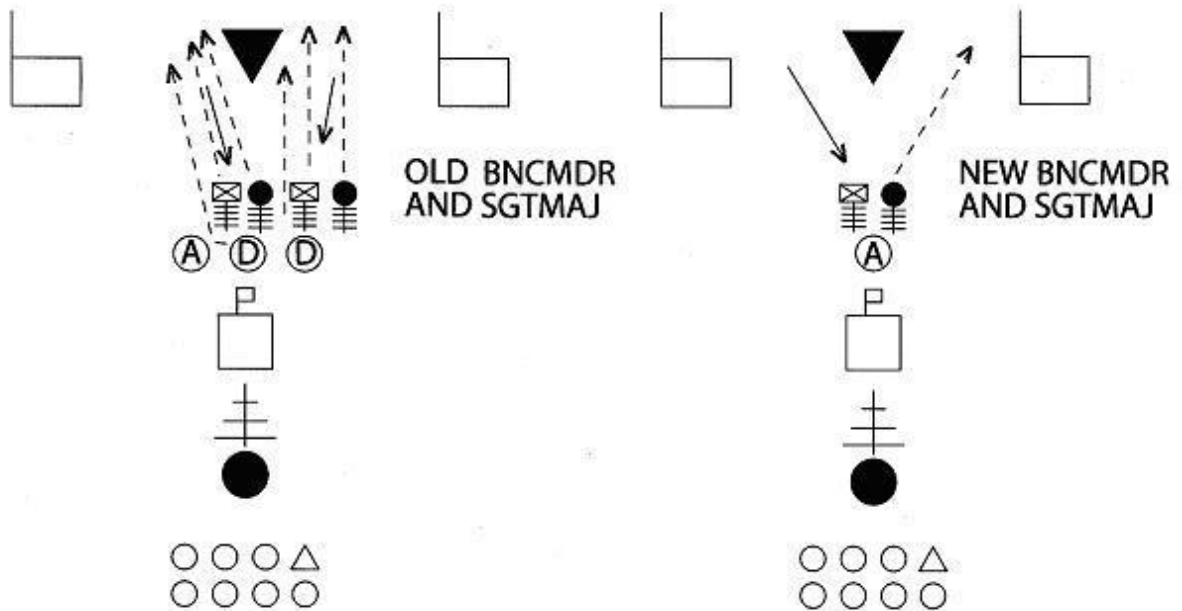

Step 3 - Retiring Colors of the Deactivated Unit

Step 4 - Colors of the Activated Unit Uncased

Figure 21-2.--Colors Center.

11. Commander commands **"POST THE GUIDONS."** The first sergeants face about and remove the new unit guidons from their position in the stand, unfurl it and march together by the most direct route to a position directly in front of the appropriate guidon bearer. (See figure 21-3.) They will pass the new guidon to the guidon bearer and then return to their normal position in the formation.

Note: At the start of this ceremony the two deactivating units each have a Headquarters and Service Company. Once the merger has occurred and the new unit activated the Headquarters and Service Company of the right battalion becomes the new Headquarters and Service Company.

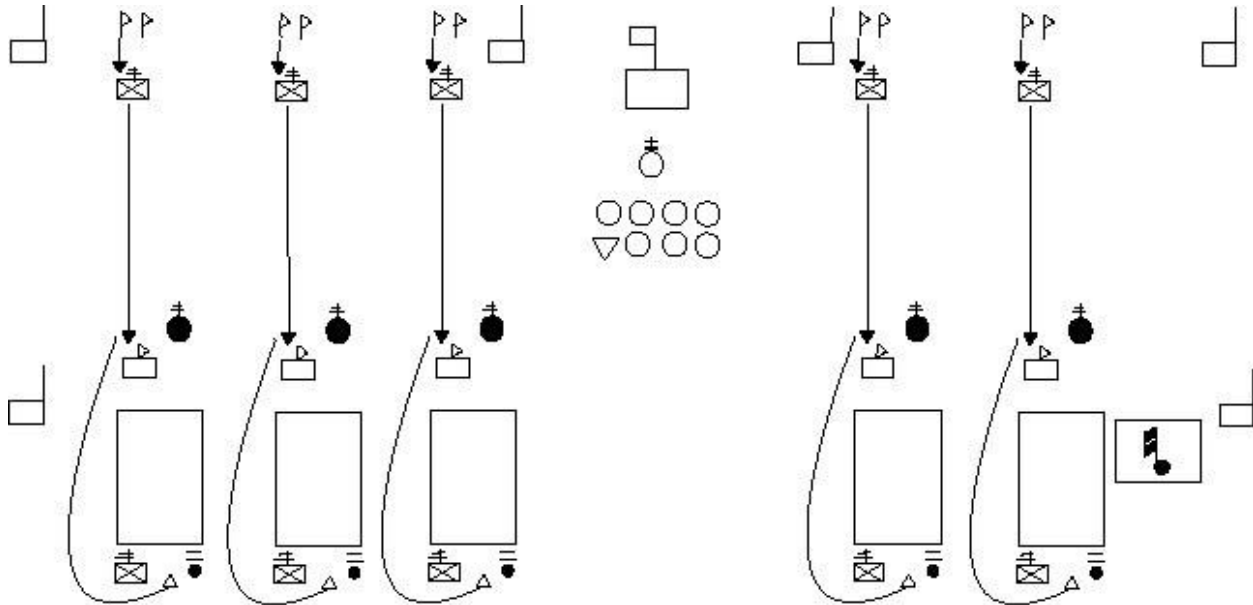

Figure 21-3.--Post the Guidons.

12. Commander commands **"PRESENT THE COMMAND."**

a. The commander of troops will present the command as outlined in paragraph 17006. After the command is presented and brought back to the order it is placed at parade rest and the new commander delivers remarks.

b. After all remarks are completed the command is brought to attention and the colors are posted. The new unit's organizational colors will follow the color guard back to the line of troops and when the color guard countermarches, the organizational colors will march around and resume its position in the formation behind the color guard.

13. At this point the command will march in review as described in chapter 17.

MARINE CORPS DRILL AND CEREMONIES MANUAL

SECTION II: CEREMONIES

CHAPTER 22

HONORS

	<u>PARAGRAPH</u>	<u>PAGE</u>
PRESCRIBED HONORS	22000	22-3
RENDERING HONORS TO PERSONAGES ARRIVING FOR OFFICIAL VISITS ASHORE	22001	22-3
RENDERING HONORS TO PERSONAGES DEPARTING AFTER OFFICIAL VISITS ASHORE	22002	22-7
ESCORT OF HONOR	22003	22-8
ADDITIONAL HONORS	22004	22-8
GUN SALUTE	22005	22-8
HONORS FOR OFFICIAL VISITS OF UNITED STATES OFFICERS (ARTICLE 1035)	22006	22-11

FIGURE

22-1	HONORS MATRIX	22-11
------	-------------------------	-------

MARINE CORPS DRILL AND CEREMONIES MANUAL

SECTION II: CEREMONIES

CHAPTER 22

HONORS

22000. PRESCRIBED HONORS

1. See *U.S. Navy Regulations* for tables of prescribed honors to be rendered afloat.
2. Except as set forth below, the same salutes, honors, and ceremonies, insofar as practicable, are rendered in connection with official visits to Naval stations and Marine Corps posts and bases as are rendered on similar visits to Navy ships.
3. Normally, a unit other than the interior guard will be detailed as the honor guard at shore-based establishments.
 - a. For a personage who merits a full guard, the honor guard will usually consist of at least two platoons of riflemen, a band and colors.
 - b. If sufficient personnel are not available to meet this requirement, the full guard will consist of not less than one platoon of riflemen.
 - c. For a personage who merits the guard of the day, the honor guard will consist of one platoon of riflemen.
 - d. The band and colors will not be included unless the guard consists of at least two platoons.
4. The following elements required in honors afloat are omitted when rendering honors ashore:
 - a. Manning the rail.
 - b. Piping alongside or over the side.
 - c. Side boys.
5. Only persons who are entitled honors and actually participate in any of the ceremonies described in chapter 15 will be accorded honors during the ceremony. If several persons rate honors are participating in the same ceremony then normally only the senior will receive honors. The exception to this is during a change of command when multiple honors may be appropriate.
6. The senior person participating has the option of differing honors to another that is also participating. Also, a person entitled to honors may differ a gun salute and elect instead to receive only musical honors.

22001. RENDERING HONORS TO PERSONAGES ARRIVING FOR OFFICIAL VISITS ASHORE

1. See *U.S. Navy Regulations* for the appropriate musical honors, gun salutes and display of personal or national flags.

2. Officers and noncommissioned officers will normally be armed with the sword for these ceremonies. At such locations where the sword is not required, or available, those individuals will be armed with the pistol. Personnel so armed will execute the hand salute in lieu of present sword, and during the inspection of the honor guard, will execute inspection arms as the personage halts at their position.

3. The commanding officer, senior officer present, or the representative of either, is the host and participates in the ceremony described herein. The commander ascertains from the visiting personage whether he/she desires to inspect the honor guard, or to pass around the honor guard as in a review, or to do neither. The commander also ascertains from the visiting personage whether, following any of the three alternatives above, he/she desires the honor guard to march in review, or does not so desire. The commander then advises the personage of the action to be taken in the ceremony.

4. Prior to the arrival of the visiting personage, the honor guard will form on line at normal interval and at closed ranks. Platoon commanders are 6 paces in front of and centered on their platoons. The band takes position to the right of and on line with, the honor guard. The colors are posted in the center of the formation, excluding the band, and on line with the honor guard. Commander of the honor guard is 12 paces in front of and centered on the color guard.

→ 5. The band sounds attention upon appearance of the visiting personage, and the honor guard is called to attention. The host welcomes the personage and escorts him/her to a position directly in front of and facing the commander of the honor guard, and takes his/her position to the left of the personage. The distance of this position from that of the commander of the honor guard will depend on local conditions, but it should be sufficient to permit the band and honor guard to pass in review. If sufficient space is not available to permit the march in review, the host will so inform the personage. The commander of the honor guard then executes carry sword, faces about and commands **"Present, ARMS."** and the honor guard goes to present arms. The commander of the honor guard then faces about again and presents sword.

6. As the commander of the honor guard executes present sword, the band plays the appropriate honors. If a gun salute is to be fired, it is begun immediately after the last note of the music. During rendering of honors and the firing of the gun salute, all observers in the vicinity of the honor guard formation stand at attention facing the personage, or if he/she is not in view, toward the honor guard formation. Observers in uniform shall salute during the playing of musical honors and the firing of the gun salute.

7. If a personal flag or a foreign national flag is to be displayed during the visit, it is hoisted at the first note of the music. If a foreign national flag is to be displayed during the gun salute, it is hoisted or unfurled at the sound of the first gun salute and hauled down, or furled, at the sound of the last gun salute. If the personage merits display of the national flag during the gun salute, it is not necessary to display another ensign if one is already flying from the flagstaff of the installation.

8. On completion of musical honors or the gun salute, the commander of the honor guard executes carry sword, faces about and commands **"Order, ARMS,"** and the honor guard goes to order arms. The commander of the honor guard then faces about again, executes present sword, and reports **"Sir/Ma'am, the honor guard is formed."**

Enclosure (1)

9. If the personage desires to inspect the honor guard, the host escorts the personage to a position 3 paces in front of the position of the commander of the honor guard.

a. The commander of the honor guard then executes carry sword, faces about and commands **"PREPARE FOR INSPECTION."**

b. The platoon commanders go to carry sword, face their platoons, and from right to left command **"Open Ranks, MARCH."** The platoon executes open ranks and the platoon commander moves to verify alignment as described in paragraph 9016. After verifying alignment the platoon commander moves to a position 1 pace to the right of and 3 paces in front of the guide, halts, faces down the front rank and commands **"Ready, FRONT"** and **"COVER."** The platoon commander then takes 1 step forward, halts, so that he/she is now 3 paces in front of the guide, faces right and goes to order sword.

c. When all platoons have opened ranks and the platoon commanders are in position 3 paces in front of the guide, facing front, the commander of the honor guard faces about, executes present sword, and reports **"Sir/Ma'am, the honor guard is prepared for your inspection."**

d. The commander of the honor guard then guides the personage, accompanied by the host and others of the official party, through the inspection, remaining at carry sword. The inspection commences at the right front of the band and proceeds along the line of platoons. As the personage halts in front of the platoon commander, the platoon commander executes present sword, and after being personally inspected, goes to carry sword, takes position on the right of the personage, and precedes the personage throughout the inspection of the platoon.

e. The band begins playing as soon as the commander of the honor guard, the personage and the party step off in the direction of the band.

f. Each member of the platoon will execute the movements to inspection arms for their weapon as the personage to be honored approaches, regardless of whether this personage halts and faces him directly or not. If the personage does not halt, and after the last member of the official party has passed the Marine's position, each member of the honor guard will execute port arms and order arms without command.

g. Upon completion of the inspection of the Marine's platoon, the platoon commander, having led the personage down the rear of the last squad executes a column left and halts 3 paces in front of the guide to receive the inspection critique. The platoon commander exchanges salutes with the personage, permits the personage and host to pass in front of the platoon, faces to the left and commands **"Close Ranks, MARCH."** The platoon executes close ranks as described in paragraph 9017 and the platoon commander moves to a position 6 paces in front of, and centered on the platoon, halts, facing front, and goes to order sword.

h. The inspecting party renders salutes as they pass in front of the colors, but not when passing to the rear of the colors.

i. After completing the inspection of the platoon(s), the inspecting party passes around the rear of the formation and the right flank of the band. The commander of the honor guard executes a column left and moves to a position 3 paces in front of the right flank of the band and halts facing front. The personage receiving the honors halts in front of and facing the commander of the honor guard. Salutes are exchanged and the personage, host and other members of the inspecting party step off to their next position to receive the march in

review. When the personage and the party have cleared his/her path, the commander of the honor guard steps off and returns to his/her post halts facing front and goes to order sword.

j. The band stops playing.

10. If the personage does not desire to inspect, but merely to pass around the honor guard, the host, after the commander of the honor guard has reported **"Sir/Ma'am, the honor guard is formed,"** escorts the personage directly toward the right front of the band. The commander of the honor guard executes carry sword, faces to the right as in marching, and proceeds to a point where he/she joins the personage and host, and troops the line.

a. The band begins playing.

b. The order of precedence for the inspecting party, from left to right as they march down the line is: personage, host, and commander of the honor guard.

c. The commander of the honor guard guides the personage along the front of the band, across the front of the honor guard between the front rank and platoon commanders.

d. The inspecting party then passes along the left flank and rear of the honor guard and around the right flank of the band. The commander of the honor guard executes a column left and moves to a position 3 paces in front of the right flank of the band and halts facing front. The personage receiving the honors halts in front of and facing the commander of the honor guard. Salutes are exchanged and the personage, host and other members of the inspecting party step off to their next position to receive the march in review. When the personage and the party have cleared his/her path, the commander of the honor guard steps off and returns to his/her post, halts facing front and goes to order sword.

e. The band stops playing.

11. If the personage desires the honor guard to pass in review only, or to pass in review following an inspection or pass around, he/she will command the commander of the honor guard to **"March the Guard in Review, Sir."**

a. The commander of the honor guard executes carry sword, faces about and commands **"PASS IN REVIEW."** The band then changes direction on the line of march and halts.

b. The commander of the honor guard then commands **"Right, FACE."** The guard executes. The platoon commanders go to carry sword and move to their position at the head of their platoons.

c. The commander of the honor guard then commands **"Right Shoulder, ARMS."** The guard executes. The color guard goes to carry colors executes a right turn and halts.

d. The commander of the honor guard then moves to a position behind the band and at the head of the column of troops formed by the guard.

e. The commander of the honor guard then commands **"Forward, MARCH."** The band and guard step off simultaneously and marches in review. The commander of the honor guard salutes and executes eyes right without command, when 6 paces from the host and visiting personage, and without command terminates the salute and eyes right when 6 paces past the host and visiting personage.

f. Platoon commanders give their platoons the command of **"Eyes, RIGHT"** when 6 paces from the host and visiting personage. Platoon commanders will give their platoons the command of **"Ready, FRONT"** when the last element of the platoon is 6 paces past the host and visiting personage.

→ g. The drum major and the color guard execute eyes right and salute when 6 paces from the host and visiting personage and then execute ready front when 6 paces past the host and visiting personage

h. After the band has passed the position of the host and visiting personage the band executes three column left movements so as to position themselves in front of and facing the host and visiting personage and approximately 12 paces from the left flank of the marching units. The band continues to play and marches from the field following the last marching unit of the honor guard to pass in review.

i. The commander of the honor guard, after passing in review, continues to march down the line of march and leads the honor guard from the field to a designated area and dismisses the guard.

12. If the personage does not desire to have the honor guard pass in review, the commander of the honor guard executes carry sword, faces about and commands **"Present, ARMS."** The honor guard executes present arms. The commander of the honor guard then faces the visiting personage and executes present sword. When the personage returns the salute the commander of the honor guard executes carry sword, faces the honor guard and commands **"Order, ARMS."** The honor guard goes to the order. The commander of the honor guard then faces the visiting personage and goes to order sword. The honor guard remains at attention until the visiting personage has departed. At that time the honor guard is dismissed.

13. The conduct of honor guard ceremonies as outlined above may be modified by commanders when the nature of the ground or exceptional circumstances require such changes.

14. Procedures for the conduct of a joint service honor guard will be as directed by the service commander charged with the conduct of the ceremony.

15. The conduct of honor guard ceremonies at Marine Barracks, Washington, DC. will be conducted as prescribed by the Commandant of the Marine Corps.

22002. RENDERING HONORS TO PERSONAGES DEPARTING AFTER OFFICIAL VISITS ASHORE

1. Honors are rendered upon the departure of a personage entitled to honors in the same manner in which they were rendered upon arrival with the following exceptions:

a. Generally, if the personage inspected the honor guard upon arrival, the host advises him/her that another inspection on departure is not expected.

b. The honor guard will not pass in review.

c. Honors do not commence until the personage has completed their personal farewells.

d. If a gun salute is to be fired, it will begin just prior to the time the personage leaves the area where honors are rendered.

Enclosure (1)

e. If a personal or foreign national flag has been flown during the visit, it will be hauled down upon the last note of musical honors, if no gun salute is fired, or when the last gun is fired.

22003. ESCORTS OF HONOR

1. Escorts of honor are detailed to receive and escort civilian and military persons of high rank. Troops ordered to this duty are selected for their military appearance, bearing and superior discipline.
2. The escort is formed in line opposite the place where the person to be honored is to present himself/herself. The band forms on the flank of the escort in the direction toward which the escort is to march. The escort is brought to attention upon the appearance of the person to be honored. When he/she has taken the position from which he/she will receive the honors, the escort is brought to present arms, and honors due his/her rank are rendered. Upon completion of the honors, the escort is brought to order arms.
3. Ordinarily, the person so honored will, upon completion of the honors, inspect the escort. The escort then forms in column and takes up the march. The honored person with their staff or retinue, take position in the rear of the column. When the personage leaves the escort, the Marine again forms in line; and when he/she has taken position from which to receive them, honors are rendered as upon his/her arrival.
4. When the position of the escort is a considerable distance from the point where the person to be honored is received--where a court yard or wharf intervenes--a double line of sentries, facing inboard, is posted from that point to the escort. These sentries salute as the honored personage passes their individual positions. In this case, an officer is detailed to accompany the honored personage from the place of reception to the escort.

22004. ADDITIONAL HONORS. For prescribed honors due vessels passing close aboard, dignitaries embarked in boats passing close aboard, and ships passing Washington's tomb, see *U.S. Navy Regulations*.

22005. GUN SALUTE

1. Organization
 - a. The number of guns used will be per local SOP.
 - b. The size of the gun crew will be per local SOP.
2. Positioning the Gun for a Salute
 - a. When selecting a position ensure there is no flammable material in front of the gun line.
 - b. Lay all howitzers on line.
 - c. Ensure all personnel are kept a safe distance from the front of the gun line.
 - d. Sight the gun line so that it points away from buildings and the ceremony area.

e. Distance between howitzers will of course be dependent on space provided. However, optimum distance between howitzers is 12 paces.

f. Weapons will be at "center-T" and cradle locking strut removed.

g. Lunette will be in the up position.

3. Conduct of the Gun Salute

a. At the proper time the battery gunnery sergeant will march the battery on line 3 paces to the rear of the guns. Individual sections will not march past their respective gun. When the third gun is almost in position the battery gunnery sergeant will give "**Mark Time, MARCH**" and "**Battery, HALT.**" While marking time give the sections enough time to cover between their respective trails before giving "**HALT.**" After giving the battery "**HALT,**" the battery gunnery sergeant will face the battery opposite the direction of fire and receive the report from the section chief. Once the report has been given the battery gunnery sergeant will execute an about face and wait for the officer in charge/noncommissioned officer in charge to center himself/herself and receive the report.

Note: At this time the battery gunnery sergeant should be standing at the actual center of the battery.

b. The officer in charge/noncommissioned officer in charge and the timer will march on in the most direct manner to the battery gunnery sergeant. (Note: The timers position is one pace to the left and 1 pace to the rear of the officer in charge/noncommissioned officer in charge. Use whatever supplementary drill procedures necessary to ensure that is where the Marine is when the officer in charge/noncommissioned officer in charge executes his/her facing movement to receive the report.) After the battery gunnery sergeant reports the battery is formed, the officer in charge/noncommissioned officer in charge commands "**TAKE YOUR POST.**" The battery gunnery sergeant will move 1 pace to the right (opposite the timer) and 1 pace to the rear of the officer in charge/noncommissioned officer in charge. The battery gunnery sergeant will then face in the same direction as the officer in charge/noncommissioned officer in charge. (The direction of fire.) After the officer in charge/noncommissioned officer in charge, timer and battery gunnery sergeant are in place they are commanded as the "**Staff**" ("**Staff, ATTENTION;**" "**Staff, Parade, REST;**" etc.). At this time all commands are coming from the officer in charge/noncommissioned officer in charge.

c. The officer in charge/noncommissioned officer in charge commands "**POST,**" at this time the sections will execute an about face. The officer in charge/noncommissioned officer in charge then commands "**MARCH,**" and all sections will march in the most direct manner to their respective positions. Once the Marines are in place, still facing in the direction of fire, the section chiefs in gun order will command "**Ready, FACE.**" The Marines face inboard.

d. The officer in charge/noncommissioned officer in charge commands "**LOAD**" and the loader will load a round. The breeches will be closed in gun order and the loader then comes back to the position of attention.

(Note: This only occurs on the first round, after that loading will occur as quickly as possible.)

e. If there is a substantial amount of time the officer in charge/noncommissioned officer in charge may give "**Parade, REST.**" When "*Ruffles and Flourishes*" is sounded the crew must be at attention.

f. On the last note of "*Ruffles and Flourishes*" the first round is fired. The timer starts the stopwatch on the first round. For most salutes, rounds must be fired every 5 seconds. That means on every 5-second mark a round must sound. In order for this to happen you must compensate. The officer in charge/non-commissioned officer in charge may either use hand and arm signals to fire each weapon or use verbal commands. (Example: Drop of the arm or "**NUMBER __ FIRE.**") When using the verbal command do not use the traditional "Stand-by Fire" use "**NUMBER __ FIRE.**" Normally the timer must command "**TIME**" every 3 seconds after a round has fired. To make this easy, use every 3, 8, 13, 18, 23, 28, 33, 38, etc, seconds. It is on these seconds the timer would command "**TIME**" to have a round go off at 5, 10, 15, 20, 25, 30, 35, 40, etc., seconds.

g. After firing a round loading is automatic. Loader will keep loading until rounds stop firing. This is in case of a misfire. The procedure for loading is as follows; the section chief will fire the round and open the breech, the loader will catch the sleeve with the right hand give it to the ammo man and at the same time receive a prepared round from the ammo man and load it. The cycle is continuous.

h. It is the responsibility of the battery gunnery sergeant to count each round to ensure the proper amount of rounds is fired. The battery gunnery sergeant will, at a normal tone, count out loud to the officer in charge/noncommissioned officer in charge every round as well as marking them on a piece of paper. After the second to last round the Marine will command to the battery "**LAST ROUND.**"

i. After the last round is fired the officer in charge/noncommissioned officer in charge will command "**Battery, Hand, SALUTE**" or "**Staff, Hand, SALUTE,**" and "**Staff, Ready TWO**" or "**Battery, Ready TWO.**" After the hand salute the officer in charge/noncommissioned officer in charge commands "**UNLOAD.**" All breeches are cleared using the unloading procedure discussed above.

j. After unloading is complete the officer in charge/noncommissioned officer in charge commands "**POST,**" the battery Marines do whatever movement necessary to face opposite the direction of fire. Then the officer in charge/noncommissioned officer in charge commands "**MARCH,**" the battery Marines march back to their original 3 paces behind the gun line.

k. The officer in charge/noncommissioned officer in charge calls the battery gunnery sergeant to "**Center,**" and turns the battery over to the Marine. The officer in charge/noncommissioned officer in charge then faces and leave the area in the most direct manner.

l. Then the battery gunnery sergeant will either dismiss the battery or march them off in the most direct manner.

Note: Sometimes the battery will perform in conjunction with the ceremony and everyone may have to remain in position until the ceremony is over. When the battery is actually part of the ceremony and there is more of the ceremony to be conducted after the gun salute, the officer in charge/noncommissioned officer in charge will wait until the ceremony is concluded to march off.

4. Jams and Misfires

a. If a weapon jams or misfires that weapon is out of action for the rest of the ceremony. The ammo man of that gun will evenly distribute that gun's ammunition smartly and quickly. After the ammunition is distributed the ammo man will return to his/her position on the gun.

b. When a weapon jams or misfires during a ceremony it is now time to fall on your training. When the jam or misfire occurs the section chief will command **"MISFIRE."** As soon as the next section chief hears **"MISFIRE"** the Marine will fire without command. This must be done quickly to make up for any lost time.

22006. HONORS FOR OFFICIAL VISITS OF UNITED STATES OFFICERS (ARTICLE 1035)

Officer	Uniform	Gun Salute		Ruffles and Flourishes	Music	Guard	Side Boys
		Arrival	Departure				
Chairman, Joint Chiefs of Staff	Full Dress	19	19	4	General's or Admiral's March	Full	8
Chief of Staff, U.S. Army	Full Dress	19	19	4	General's March	Full	8
Chief of Naval Operation	Full Dress	19	19	4	Admiral's March	Full	8
Chief of Staff, U.S. Air Force	Full Dress	19	19	4	General's March	Full	8
Commandant of the Marine Corps	Full Dress	19	19	4	Admiral's March	Full	8
Commandant of the Coast Guard	Full Dress	19	19	4	Admiral's March	Full	8
General of the Army	Full Dress	19	19	4	General's March	Full	8
Fleet Admiral	Full Dress	19	19	4	Admiral's March	Full	8
General of the Air Force	Full Dress	19	19	4	General's March	Full	8
Generals	Full Dress	17	17	4	General's March		8
Admirals	Full Dress	17	17	4	Admiral's March	Full	8
Naval or other military governor, commissioned as such by the President within the area of his or her jurisdiction	Full Dress		17	4	General's or Admiral's March	Full	8
Vice Admiral or Lieutenant General	Full Dress		15	3	General's or Admiral's March	Full	8
Rear Admiral or Major General	Full Dress		13	2	General's or Admiral's March	Full	6
Rear Admiral (lower half) or Brigadier General	Full Dress		11	1	General's or Admiral's March	Full	6

Figure 22-1.--Honors Matrix.

MARINE CORPS DRILL AND CEREMONIES MANUAL

PART II: CEREMONIES

CHAPTER 23

MARINE CORPS BIRTHDAY CAKE CUTTING CEREMONY

	<u>PARAGRAPH</u>	<u>PAGE</u>
GENERAL	23000	23-3
SEQUENCE OF EVENTS FOR THE MARCH ON	23001	23-3
READING THE MESSAGES AND CUTTING THE CAKE	23002	23-10
SEQUENCE OF EVENTS FOR THE MARCH OFF AND CONCLUSION OF THE CEREMONY	23003	23-12
VARIATIONS	23004	23-15
RECOMMENDED PERSONNEL ASSIGNMENTS	23005	23-16

FIGURE

23-1	PARTICIPANTS STAGED	23-3
23-2	MUSIC'S MOVEMENTS	23-4
23-3	ADJUTANT, DRUMMERS AND TRUMPETERS MOVEMENTS	23-5
23-4	MARCH ON OF GENERAL OFFICERS AND ESCORTS	23-6
23-5	MOVEMENTS OF THE COMMANDING GENERAL (OR COMMANDING OFFICER) AND GUEST OF HONOR	23-7
23-6	MOVEMENTS OF THE COLOR GUARD	23-9
23-7	MOVEMENTS OF THE CAKE	23-10
23-8	MOVING THE CAKE IN ORDER TO CLEAR THE LINE OF MARCH	23-13
23-9	MARCH OFF OF COLOR GUARD, COMMANDING GENERAL, GUEST OF HONOR AND GENERAL OFFICERS	23-13
23-10	MOVEMENTS OF THE ESCORTS DURING THE MARCH OFF	23-14
23-11	MOVEMENTS OF THE DRUMMERS AND TRUMPETERS DURING THE MARCH OFF	23-15

PART II: CEREMONIES

CHAPTER 23

MARINE CORPS BIRTHDAY CAKE CUTTING CEREMONY

23000. GENERAL. The following procedure is prescribed as a guide for the conduct of the Marine Corps Birthday Cake Cutting Ceremony. It is outlined on the basis of a Marine Corps post commanded by a general officer. At post where no general officer is present, and a staff noncommissioned officer, enlisted or unit balls, modifications may be made as necessary to meet local conditions. Rehearsals must be conducted to ensure that the ceremony proceeds smoothly and precisely.

23001. SEQUENCE OF EVENTS FOR THE MARCH ON

1. H-Hour-15 Minutes. All participants in the ceremony are formed at the entrance to the ballroom. (See figure 23-1.) All bars, if any, will close.

CEREMONY LOCATION

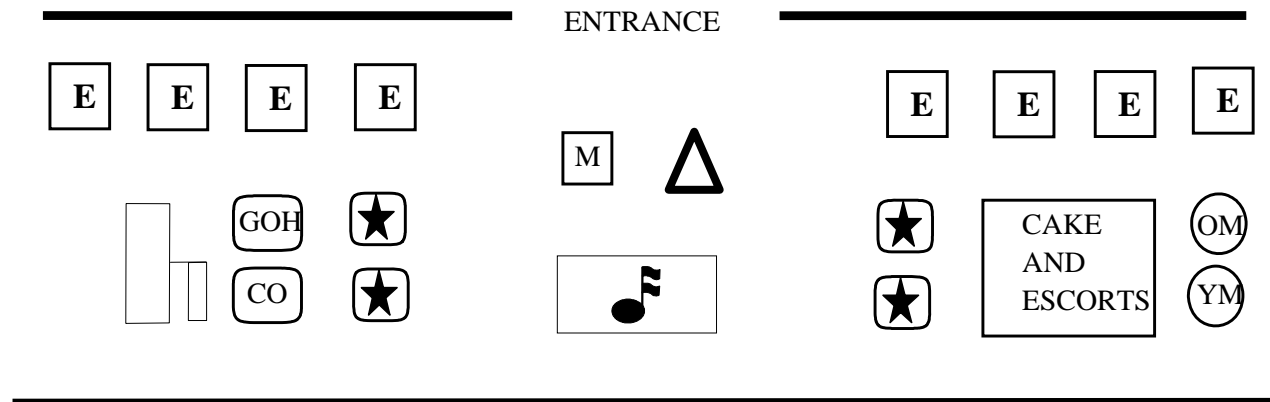

LEGEND

- | | | |
|------------------|--------------------|------------------------------|
| = ESCORT | = GENERAL OFFICER | = ADJUTANT |
| = GUEST OF HONOR | = OLDEST MARINE | = DRUM & TRUMPET
DETAIL ← |
| = CO/CG | = YOUNGEST MARINE | = MUSIC |
| | = NARRATOR/LECTURN | = COLOR GUARD |

→ Figure 23-1.--Participants Staged.

Enclosure (1)

2. H-Hour-5 Minutes

- a. Bugler moves to position centered on the dance floor and sounds "Attention," followed by "Officers Call" (or "First Sergeant's Call" at staff noncommissioned officer/enlisted balls) and then departs the floor and returns to a position with the drummers and trumpeters. (See figure 23-2.)
- b. The escorts draw swords and go to parade rest.

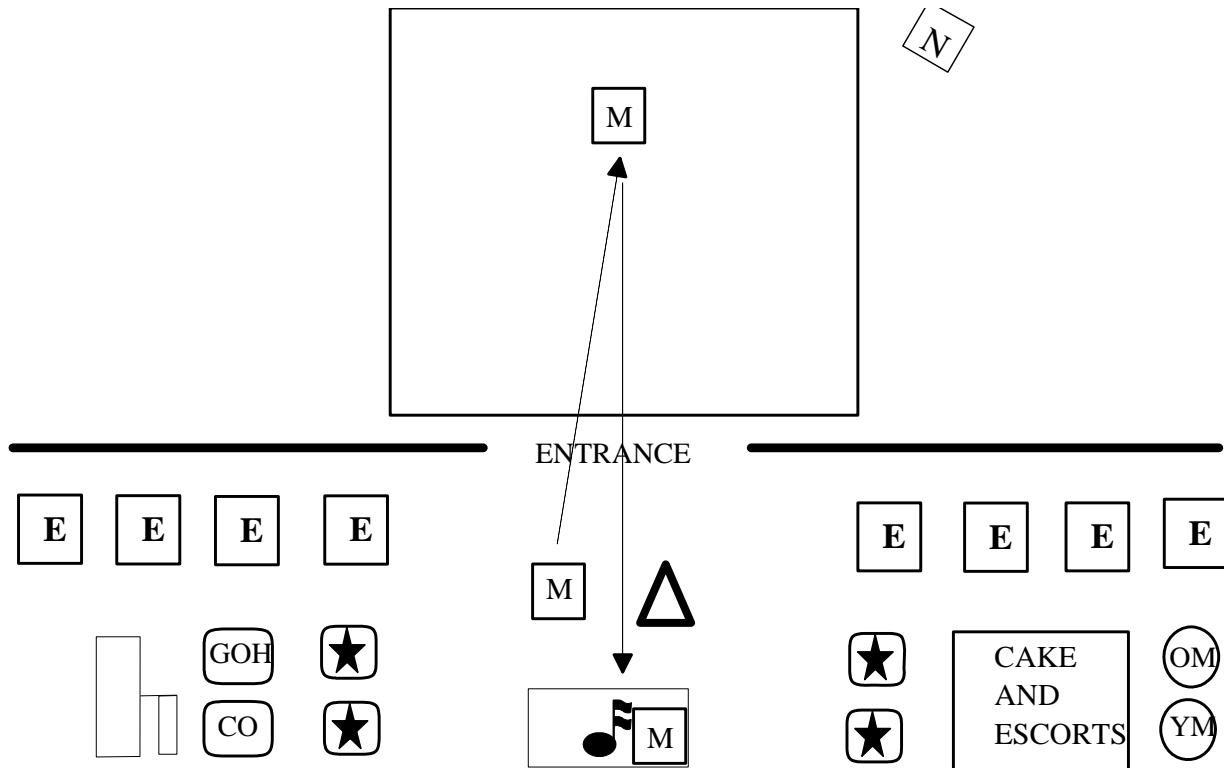

Figure 23-2.--Music's Movements.

NARRATOR: "GOOD EVENING LADIES AND GENTLEMEN, WELCOME TO THE UNITS NAME BALL CELEBRATING THE # OF BIRTHDAY (e.g., 221ST) BIRTHDAY OF OUR CORPS. (INVOCATION OPTIONAL) PLEASE RISE AS NAME OF CHAPLAIN DELIVERS THE INVOCATION." Chaplain delivers the invocation.

NARRATOR: "LADIES AND GENTLEMEN PLEASE BE SEATED AS THE CEREMONY IS ABOUT TO BEGIN."

3. H-Hour. The adjutant moves to a position at the far end of the dance floor from the entrance, halts faces the entrance, and draws sword. (See figure 23-3.)

- 4. Adjutant commands "SOUND ATTENTION." Drum and trumpet detail sounds "Attention." Escorts execute attention without command.
- 5. Adjutant commands "SOUND ADJUTANT'S CALL." Drum and trumpet detail sounds "Adjutant's Call."

Enclosure (1)

- a. Immediately after "Adjutants Call" the drum and trumpet detail plays "French Foreign Legion." Drum and trumpet detail marches down a cleared lane to the far end of the dance floor, countermarches in front of the adjutant, and followed by the adjutant, marches back to the main entrance, countermarches again, and halts. Drum and trumpet detail then moves sufficient distance left or right to clear the entrance doorway.
- Note: If the ballroom is too small for the drum and trumpet detail to remain on the dance floor, or if they are part of the main band, then they would march off the dance floor.
- b. The adjutant moves to a position behind the cake. The march is ceased on command of the drum major. (See figure 23-3.)

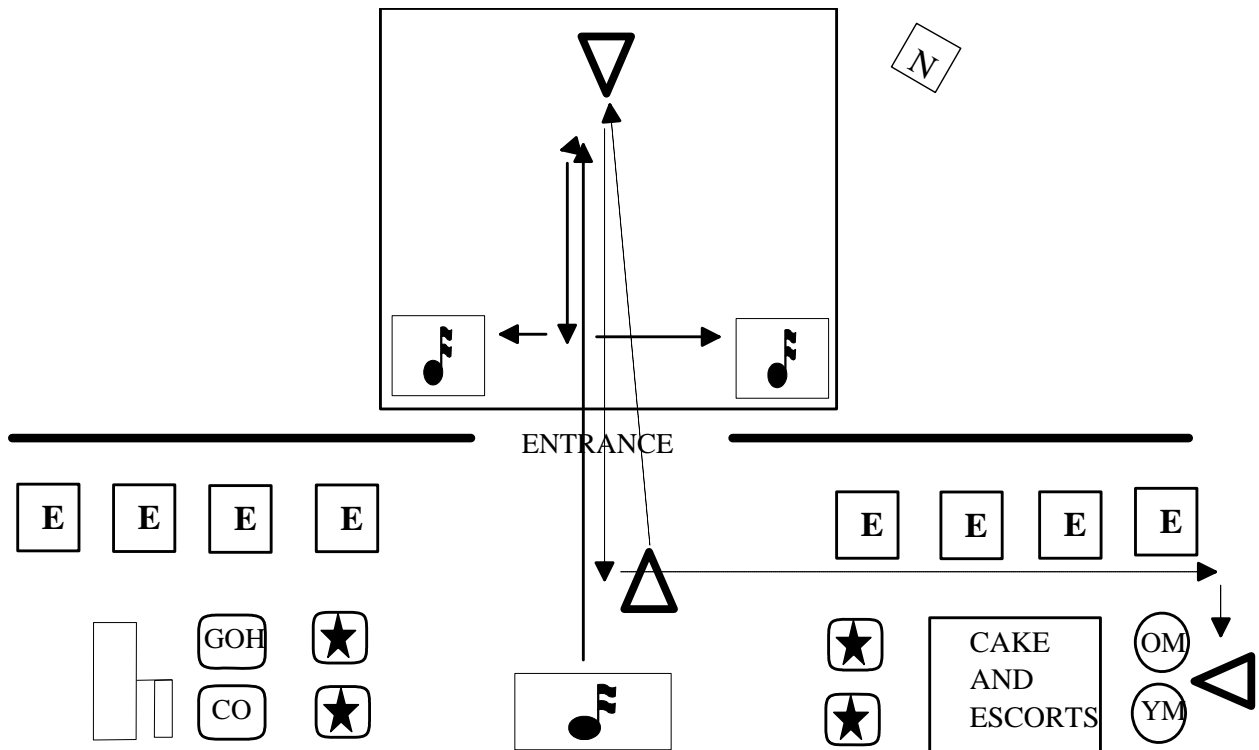

Figure 23-3.--Adjutant, Drummers and Trumpeters Movements.

6. Senior escort commands "**Forward, MARCH.**"

- a. Band commences playing "*Semper Fidelis.*"
- b. The two senior escorts (1st pair) enter the ball room together and march to their position at the far end of the dance floor, halt, face outboard, march forward to their position (4-8 paces) halt, face about and go to order swords.
- c. The remainder of the escorts step off by twos (2nd pair, 3d pair, etc.) from senior to junior, at 4-pace intervals and move to their position on the

Enclosure (1)

dance floor in the same manner as the lead escorts, the two lines forming the two long sides of a hollow rectangle. (See paragraph 23005 for the recommended composition of escorts.)

d. Once all escorts are in position and at order sword, general officers, if present, enter the ball room in pairs from the main entrance, march down the line of escorts to their position at the far end of the dance floor, halt and face the entrance thus forming the third side of the rectangle.

e. Two spaces are left open in the center of the line of general officers. When all are in position the band stops playing. (See figure 23-4.)

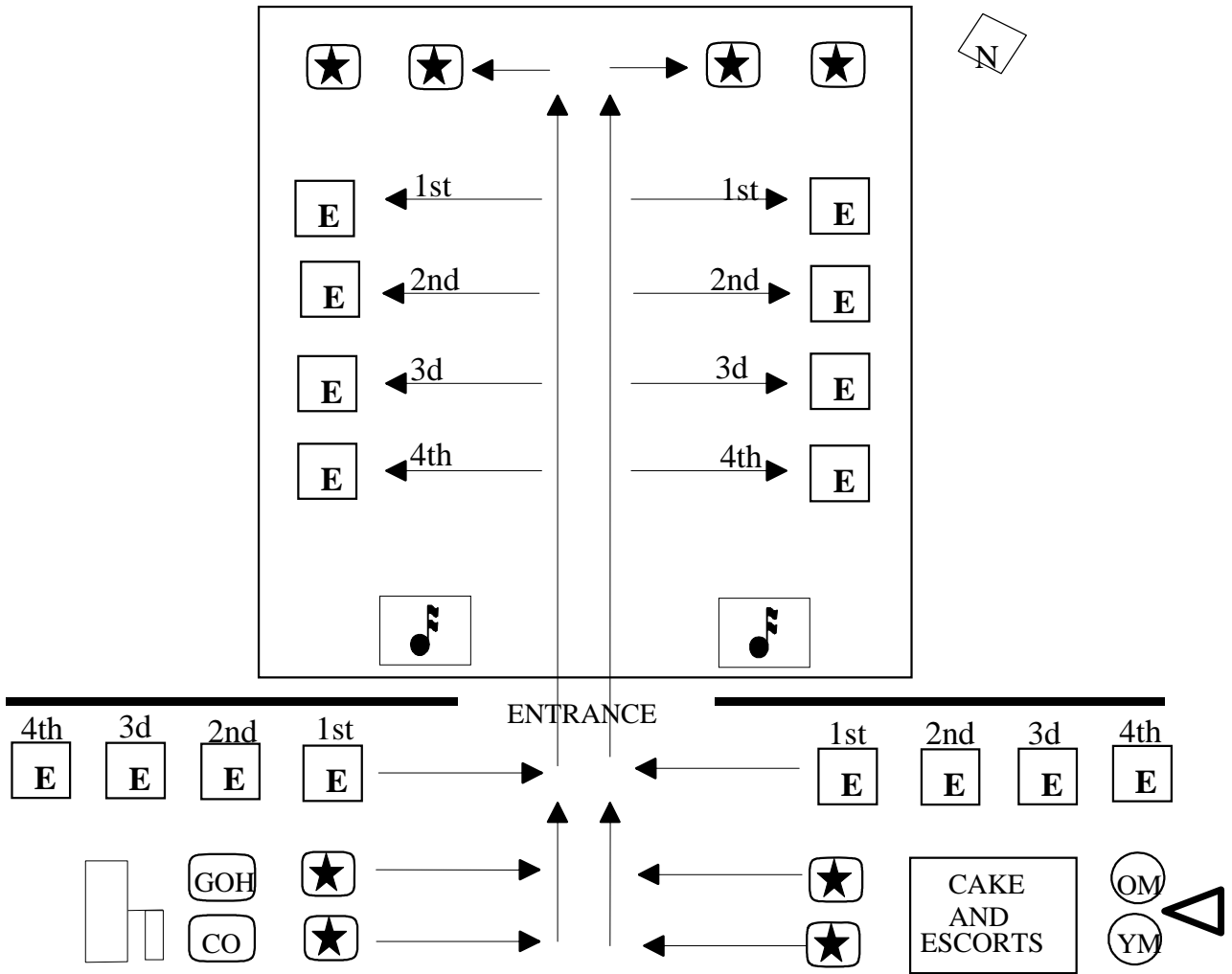

Figure 23-4.--March on of General Officers and Escorts.

→ f. Band sounds "Attention." The commanding general (see note) and the guest of honor enter the ballroom together and move to a position centered between the line of escorts and halt. (See figure 23-5.)

Enclosure (1)

NARRATOR: "LADIES AND GENTLEMEN PLEASE RISE FOR HONORS TO THE COMMANDING GENERAL (GUEST OF HONOR AND COMMANDING OFFICER) AND REMAIN STANDING FOR THE MARCH ON OF THE COLORS, THE "NATIONAL ANTHEM" AND THE ENTRY OF THE TRADITIONAL BIRTHDAY CAKE."

Note: At a ball where neither the guest of honor nor the escort rate musical honors then the narrator makes the above statement but no musical honors are rendered. The escorts simply **"Present, ARMS."** In this case the line of general officers would be omitted.)

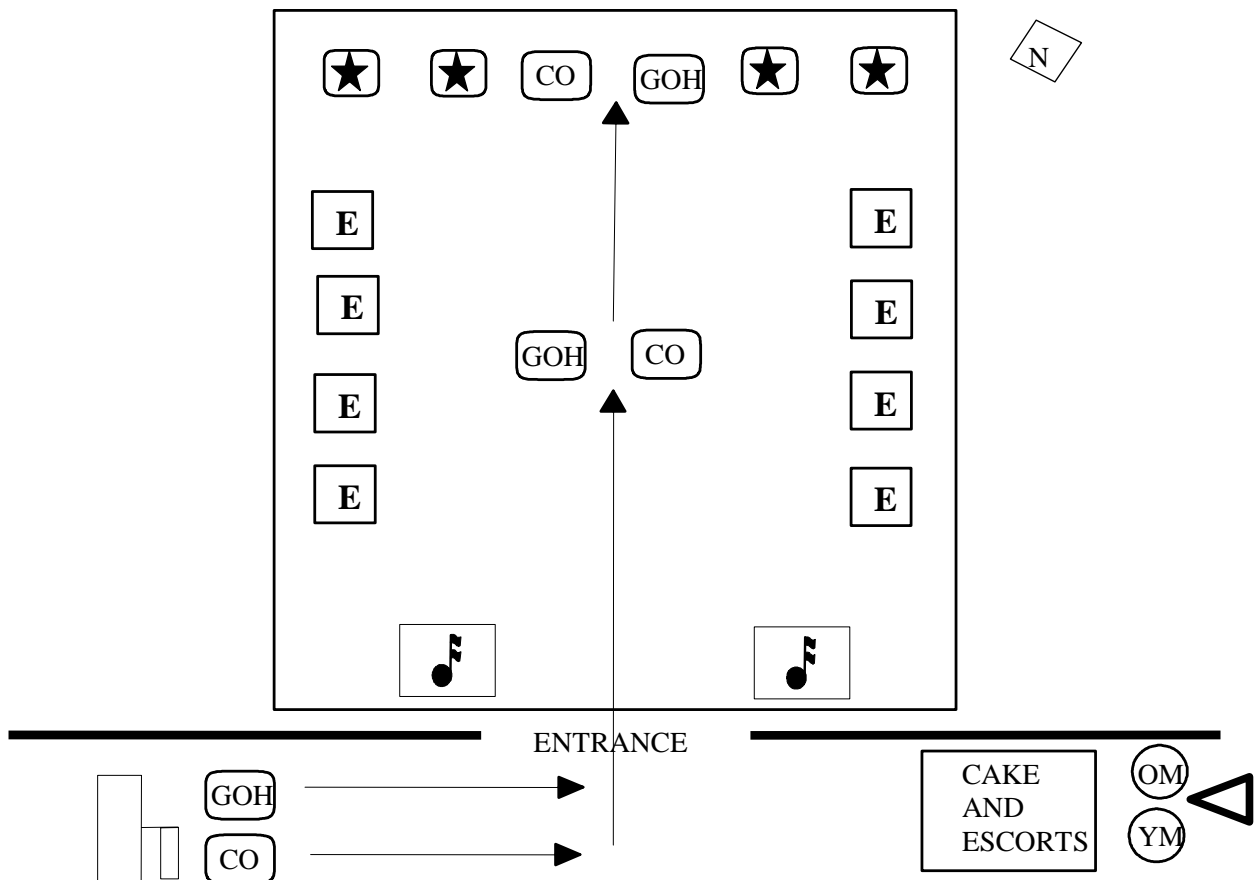

Figure 23-5.--Movements of the Commanding General (or Commanding Officer) and Guest of Honor.

7. The senior escort commands **"Present, SWORD."** The escorts execute present sword. The band plays appropriate musical honors. The commanding general (or commanding officer) and the guest of honor return the salute if covered. After the last note of honors the commanding general (or commanding officer) and guest of honor terminate their salute.

8. The senior escort commands **"Order, SWORD."** The escorts execute order sword. The commanding general (or commanding officer) and guest of honor move to their positions in the line of general officers, halt and face about. (See figure 23-5.) When both are in position.

- 9. Band sounds "*Attention.*" The color guard enters the ballroom at the carry and marches to a point halfway down the line of escorts, halts and remains at the carry (see figure 23-6).
10. The senior escort commands "**Present, SWORD.**" The escorts present sword.
- a. Commanding general (or commanding officer), guest of honor and general officers, if covered, salute on the first note of the music.
- b. The color guard riflemen execute present arms from the carry on the command of present sword by the senior escort. The band then plays the "*National Anthem.*" The organizational colors presents on the first note of the music and returns to the carry on the last note.
- c. Commanding general (or commanding officer), guest of honor and general officers, if covered, cut their salute on the last note of the music.
11. The senior escort commands "**Order, SWORD.**" The escorts order sword.
- a. The color guard riflemen return to the carry. The color guard then marches forward to the far end of the dance floor, countermarches and marches back down the line of escorts to their position by the main entrance, countermarches, halts and goes to the order. The color guard then separates by executing sufficient left and right steps for the cake and escorts to enter the ballroom. (See figure 23-6.) Once the color guard is in position.
- b. Band sounds "*Attention.*"
- c. The band then plays the "*Marines Hymn*" (slow version) and the cake escorts (see paragraph 23005.3 for the recommended composition of the cake escorts) enter the ballroom. Between them they push a serving cart on which are placed the birthday cake, a Marine sword (officer or noncommissioned officer), two plates, three forks and napkins. The oldest and youngest Marine present, and adjutant follow the cake. The escorts slowly roll the cake to a position in front of the commanding general (or commanding officer), halt, take one side step and face inboard toward the cake. (See figure 23-7.) The band stops playing.

NARRATOR: "LADIES AND GENTLEMEN PLEASE BE SEATED."

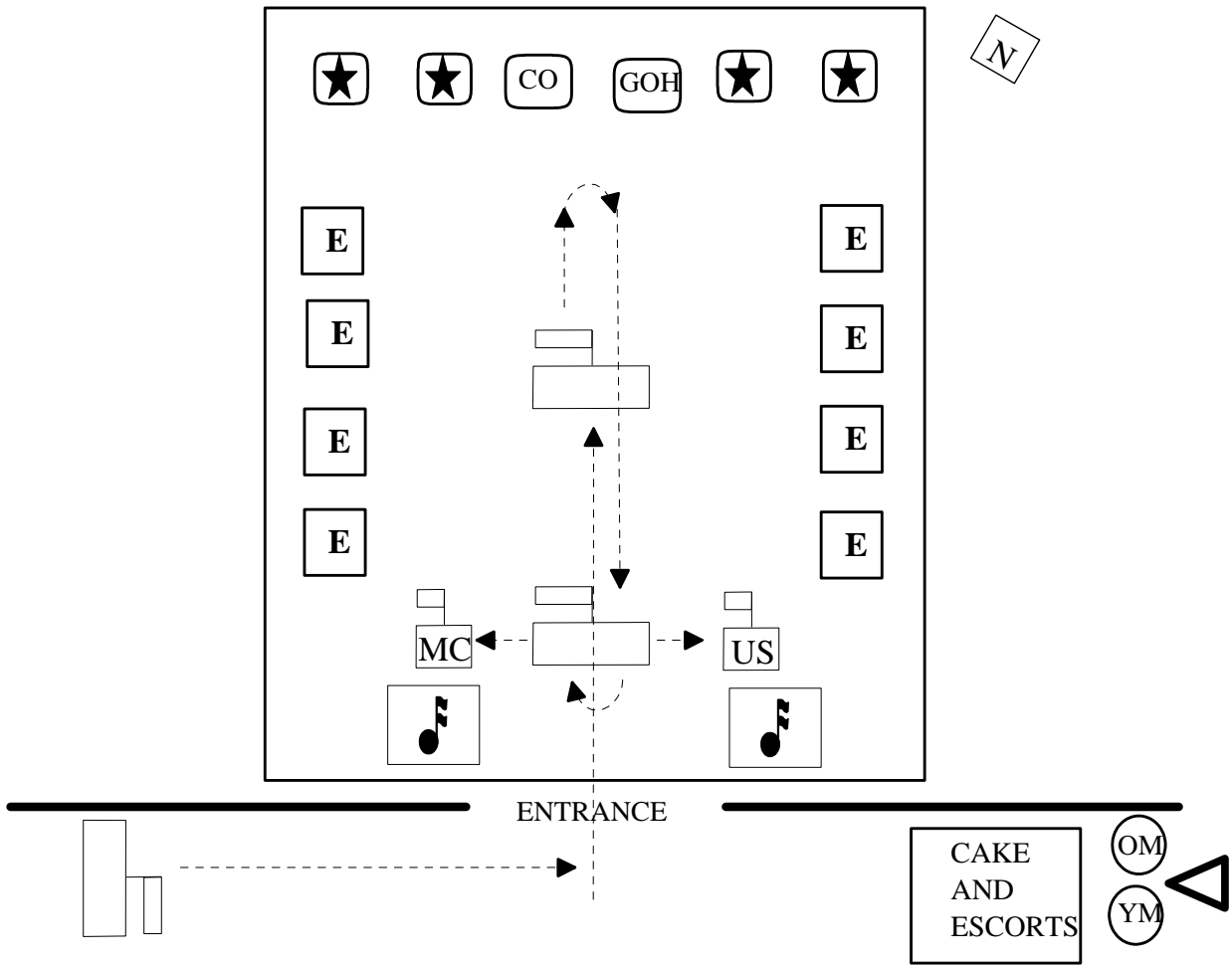

Figure 23-6.--Movements of the Color Guard.

12. The senior escort commands **"Parade, REST."** All escorts, cake escorts, color guard, band, general officers and guest of honor execute.

a. The adjutant remains at attention, faces about goes to order sword, and moves the sword into the position for reading documents described in chapter 5. The adjutant carries the scroll under the left arm in the same manner as a cased sword would be carried.

b. The adjutant then unfurls the scroll containing General Lejeune's Message and prepares to read it after the narrator has read the introductory statement.

Note: In particularly large formations or facilities where the adjutant may be hard to hear and/or a wireless microphone is not available, the narrator may read General Lejeune's Message. In that case the adjutant would remain at carry sword during the reading of the message.

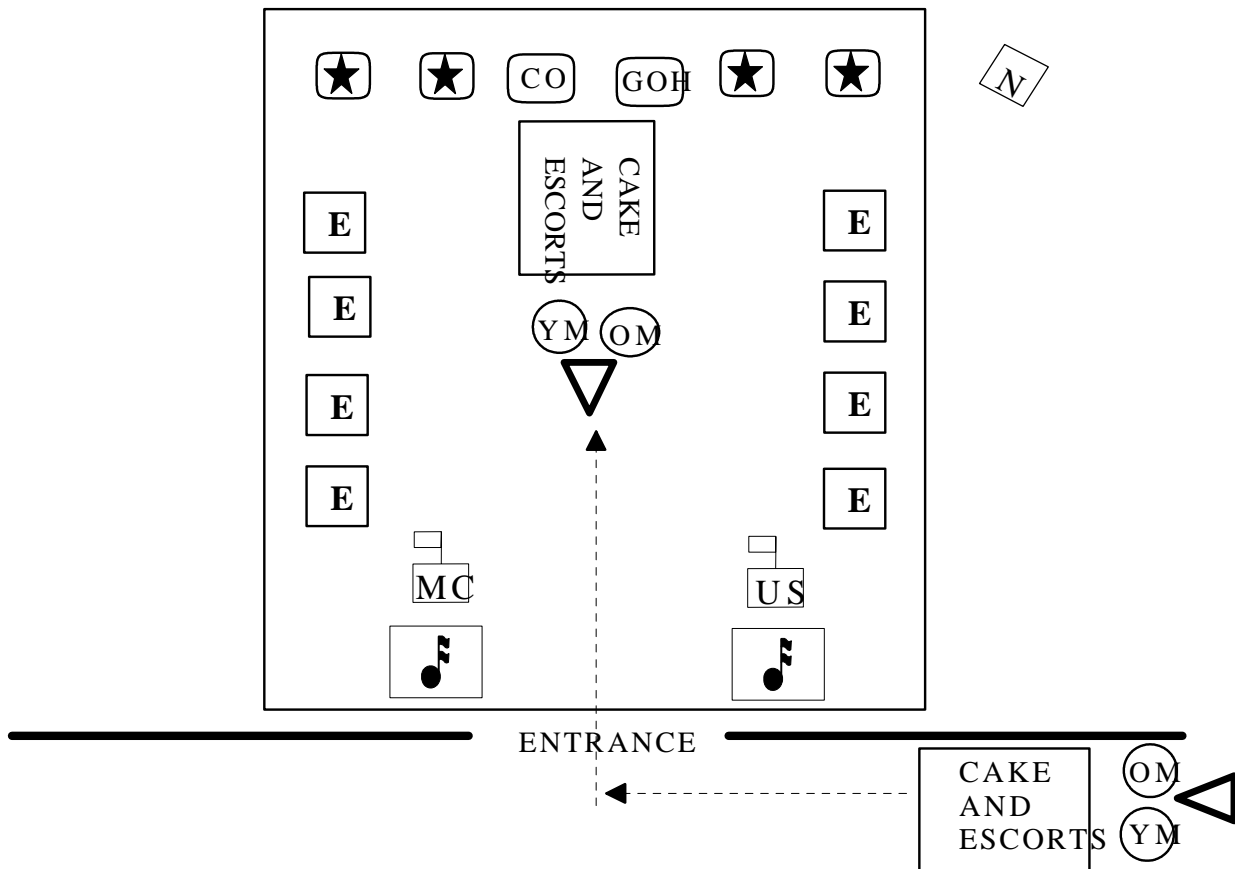

Figure 23-7.--Movements of the Cake.

23002. READING THE MESSAGES AND CUTTING THE CAKE

1. The narrator begins this portion of the ceremony by reading the introductory statement to General Lejeune's traditional birthday message.

NARRATOR: "ON NOVEMBER 1ST, 1921, JOHN A. LEJEUNE, 13TH COMMANDANT OF THE MARINE CORPS, DIRECTED THAT A REMINDER OF THE HONORABLE SERVICE OF THE CORPS BE PUBLISHED BY EVERY COMMAND, TO ALL MARINES THROUGHOUT THE GLOBE, ON THE BIRTHDAY OF THE CORPS. SINCE THAT DAY, MARINES HAVE CONTINUED TO DISTINGUISH THEMSELVES ON MANY BATTLEFIELDS AND FOREIGN SHORES, IN WAR AND PEACE. ON THIS BIRTHDAY OF THE CORPS, THEREFORE, IN COMPLIANCE WITH THE WILL OF THE 13TH COMMANDANT, ARTICLE 38, UNITED STATES MARINE CORPS MANUAL, EDITION OF 1921, IS REPUBLISHED AS FOLLOWS:

ADJUTANT/NARRATOR: ON NOVEMBER 10TH, 1775, A CORPS OF MARINES WAS CREATED BY A RESOLUTION OF THE CONTINENTAL CONGRESS. SINCE THAT DATE MANY THOUSAND MEN HAVE BORE THE NAME MARINE. IN MEMORY OF THEM IT IS FITTING THAT WE WHO ARE MARINES SHOULD COMMEMORATE THE BIRTHDAY OF OUR CORPS BY CALLING TO MIND THE GLORY OF ITS LONG AND ILLUSTRIOUS HISTORY.

THE RECORD OF OUR CORPS IS ONE WHICH WILL BEAR COMPARISON WITH THAT OF THE MOST FAMOUS MILITARY ORGANIZATIONS IN THE WORLD'S HISTORY. DURING 90 OF THE FIRST

146 YEARS OF ITS EXISTENCE, THE MARINE CORPS HAS BEEN IN ACTION AGAINST THE NATION'S FOES. FROM THE BATTLE OF TRENTON TO THE ARGONNE, MARINES HAVE WON FOREMOST HONORS IN WAR, AND IN THE LONG ERAS OF TRANQUILLITY AT HOME. GENERATION AFTER GENERATION OF MARINES HAVE GROWN GRAY IN WAR, IN BOTH HEMISPHERES, AND IN EVERY CORNER OF THE SEVEN SEAS, THAT OUR COUNTRY, AND ITS CITIZENS MIGHT ENJOY PEACE AND SECURITY.

IN EVERY BATTLE AND SKIRMISH SINCE THE BIRTH OF OUR CORPS, MARINES HAVE ACQUITTED THEMSELVES WITH THE GREATEST DISTINCTION, WINNING NEW HONORS ON EACH OCCASION UNTIL THE TERM MARINE HAS COME TO SIGNIFY ALL THAT IS HIGHEST IN MILITARY EFFICIENCY AND SOLDIERLY VIRTUE.

THIS HIGH NAME OF DISTINCTION AND SOLDIERLY REPUTE, WE WHO ARE MARINES TODAY, HAVE RECEIVED FROM THOSE WHO HAVE PROCEEDED US IN THE CORPS. WITH IT WE ALSO RECEIVED FROM THEM THE ETERNAL SPIRIT WHICH HAS ANIMATED OUR CORPS FROM GENERATION TO GENERATION AND HAS BEEN THE DISTINGUISHING MARK OF MARINES IN EVERY AGE. SO LONG AS THE SPIRIT CONTINUES TO FLOURISH, MARINES WILL BE FOUND EQUAL TO EVERY EMERGENCY IN THE FUTURE AS THEY HAVE BEEN IN THE PAST, AND THE MEN OF OUR NATION WILL REGARD US AS WORTHY SUCCESSORS TO THE LONG LINE OF ILLUSTRIOUS MEN WHO HAVE SERVED AS "SOLDIERS OF THE SEA" SINCE THE FOUNDING OF THE CORPS."

2. The adjutant, without command, then puts away the scroll, returns to carry sword and exits the ballroom. Once clear of the ballroom the adjutant returns sword, this completes his/her portion of the ceremony.

NARRATOR: "THE INSPIRING MESSAGE OF OUR 13TH COMMANDANT HAS LEFT ITS MARK IN THE HEARTS AND MINDS OF ALL MARINES." The narrator would now read the current Commandant's birthday message.

NARRATOR: "LADIES AND GENTLEMEN A MESSAGE FROM THE COMMANDANT OF THE MARINE CORPS." (text inserted here)

Note: At this time the narrator may introduce the commanding general (or commanding officer)/guest of honor for their remarks. However, remarks may be deferred until after the cake is cut in which case skip to paragraph 23002.5.

NARRATOR: "LADIES AND GENTLEMEN, THE COMMANDING GENERAL (Name and title)."

3. The commanding general makes a few brief remarks and introduces the guest of honor, who makes appropriate remarks concerning the significance of the birthday, etc., remarks should be brief and to the point.

4. After the messages are read and remarks have been completed the commanding general and guest of honor move to the cake.

5. The oldest and youngest Marine move to position on the side of the cake nearest to the commanding general. As the commanding general approaches the cake the senior cake escort steps forward, takes the sword from the cake cart and delivers it to the commanding general by passing it over the left forearm, grip toward the commanding general. (See paragraph 5017.)

6. As the commanding general cuts the cake the band begins playing "Auld Lang Syne."

7. Assistance is rendered by the cake escorts in placing the pieces on the plate.
8. The first piece is given to the guest of honor who takes a bite and returns the plate to the cake escort.
9. The second piece is placed on a plate with two forks and given to the oldest Marine who takes a bite and passes the piece to the youngest Marine who takes a bite. The youngest Marine then returns the plate to a cake escort who places it back on the serving cart.
10. While the cake is being cut and presented the narrator reads:

NARRATOR: "LADIES AND GENTLEMEN, IT IS CUSTOMARY AT MARINE CORPS BIRTHDAY CELEBRATIONS WORLDWIDE FOR MARINES TO CUT A TRADITIONAL CAKE IN CELEBRATION OF THE BIRTH OF OUR ILLUSTRIOUS CORPS. THE FIRST PIECE IS GIVEN TO THE GUEST OF HONOR, NAME AND TITLE. THE NEXT PIECE IS GIVEN TO THE OLDEST AND YOUNGEST MARINES PRESENT, SYMBOLIZING THE EXPERIENCE AND THE YOUTHFUL SPIRIT THAT ARE HALLMARKS OF OUR CORPS. THE OLDEST MARINE PRESENT IS GRADE AND NAME. HE WAS BORN ON DATE IN CITY, STATE. HE WAS COMMISSIONED/ENLISTED IN THE MARINE CORPS ON DATE AND IS CURRENTLY ASSIGNED TO UNIT AND DUTIES. THE PASSING OF THE CAKE FROM THE OLDEST TO THE YOUNGEST MARINE SYMBOLIZES THE PASSING OF HISTORY AND TRADITIONS TO THE NEXT GENERATION. THE YOUNGEST MARINE PRESENT IS GRADE AND NAME. HE WAS BORN ON DATE IN CITY, STATE. HE WAS COMMISSIONED/ENLISTED IN THE MARINE CORPS ON DATE AND IS CURRENTLY ASSIGNED TO UNIT AND DUTIES."

11. After the youngest Marine has tasted and returned the cake, the commanding general, guest of honor, oldest Marine and youngest Marine return to their positions.

Note: If the commanding general (or commanding officer)/guest of honor did not make remarks before the cake was cut the narrator would introduce them at this time.

NARRATOR: "LADIES AND GENTLEMEN, THE COMMANDING GENERAL (name and title)." The commanding general makes a few brief remarks and introduces the guest of honor, who makes appropriate remarks concerning the significance of the birthday, etc., remarks should be brief and to the point.

23003. SEQUENCE OF EVENTS FOR THE MARCH OFF AND CONCLUSION OF THE CEREMONY

1. The march off is begun by moving the cake from in front of the line of general officer to a position out of the line of march. Once the oldest and youngest Marines are in position, the cake escorts take one-step forward face left or right and re-grasp the cake cart. The senior cake escort then quietly commands the cake escorts, oldest and youngest Marines to "**Forward, MARCH,**" and moves the cake detail from the dance floor in order to clear the way for the march off. (See figure 23-8.) The cake escorts, and oldest and youngest Marines then face towards the entranceway and remain in position.
2. The senior escort commands, "**Detail, ATTENTION.**" Detail executes. The color guard begins the march off by side stepping back to close interval and going to carry colors. (See figure 23-9.)

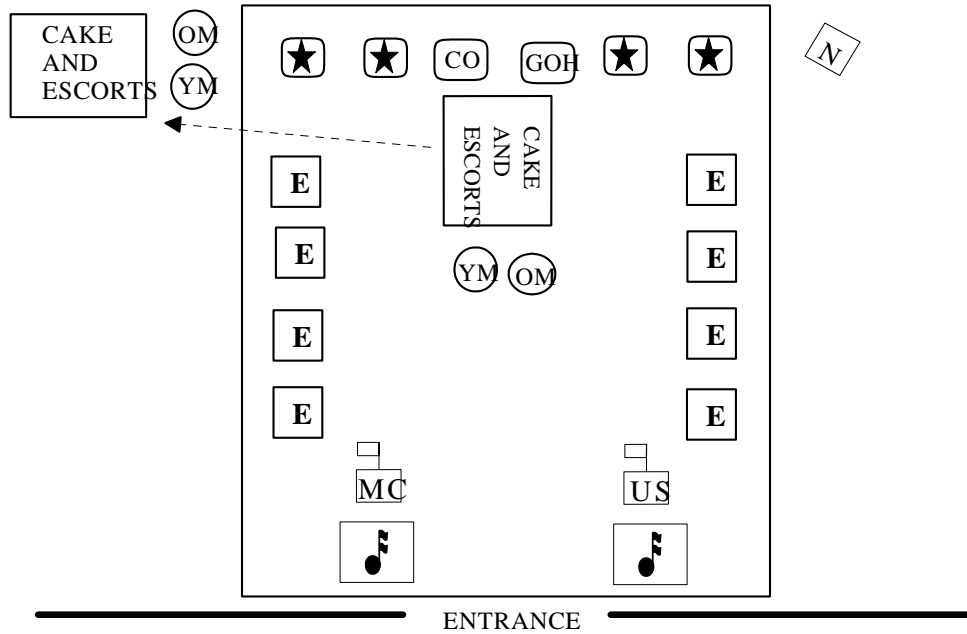

Figure 23-8.--Moving the Cake in Order to Clear the Line of March.

NARRATOR: "LADIES AND GENTLEMEN PLEASE RISE FOR THE RETIRING OF THE COLORS AND THE MARCH OFF OF THE OFFICIAL PARTY."

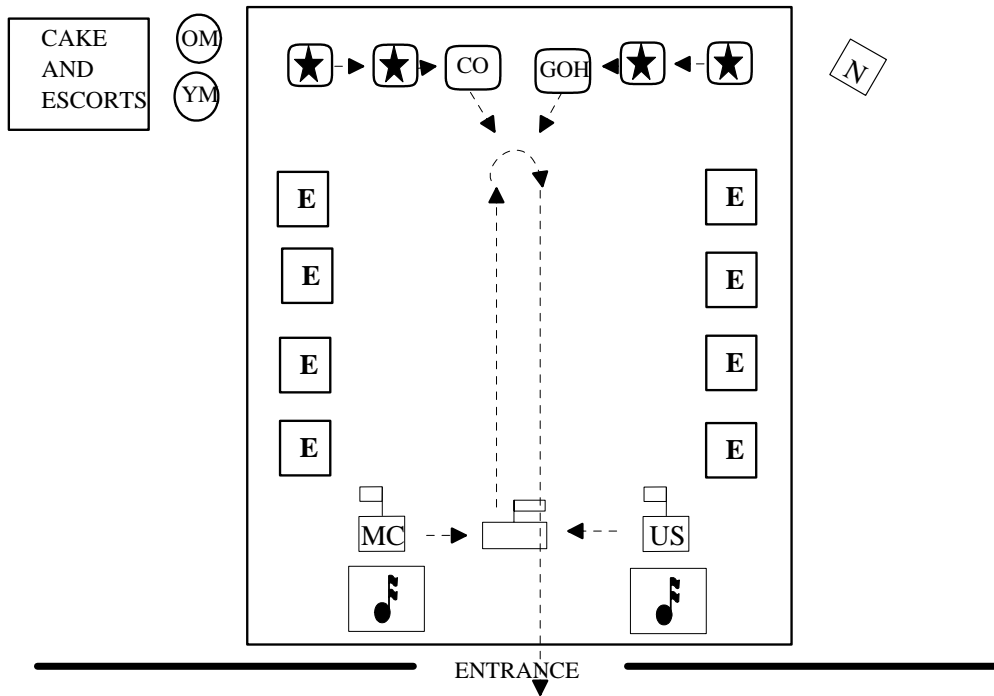

Figure 23-9.--March Off of Color Guard, Commanding General, Guest of Honor and General Officers.

3. The senior escort commands "**Present, SWORD.**" The escorts execute.
4. The color sergeant commands "**Forward, MARCH.**"
 - a. The band begins playing "*Semper Fidelis.*"
 - b. The color guard marches forward down the line of escorts to the far end of the dance floor, countermarches, marches back down the line of escorts and from the room. (See figure 23-9.)
 - c. When the colors have cleared the room the commanding general and guest of honor march down the line of escorts and from the room. When they have cleared the room they are followed in a similar manner by the remainder of the general officers, who march from the room in pairs until the last one has cleared the room. (See figure 23-9.)
5. The senior escort commands "**Carry, SWORD.**" The escorts execute.
 - a. The two senior escorts (1st pair) march forward to the centerline of the floor, halt, face the main entrance and march from the ballroom. (See figure 23-10.)
 - b. As each successive pair (2nd pair, 3rd pair, etc.) of escorts is uncovered by the preceding escorts, they march forward to the centerline of the dance floor, halt, face the main entrance and march from the ballroom. (See figure 23-10.)

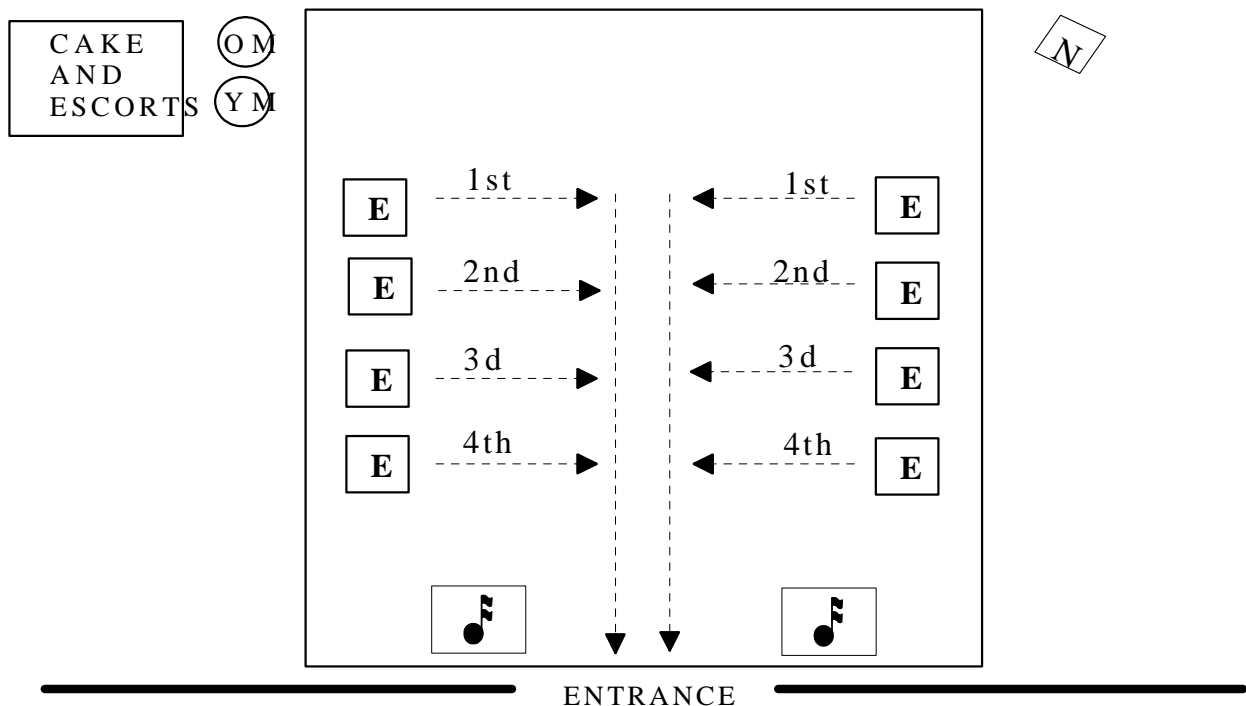

Figure 23-10.--Movements of the Escorts During the March Off.

c. After the last pair of escorts clear the room the band plays "Anchors Away" and "Marines Hymn."

Note: If the drummers and trumpeters marched out of the ballroom at the beginning of the ceremony then delete the next step.)

d. The drummers and trumpeters close by side-stepping to the right and left, take up the beat, march the length of the dance floor, countermarch, and march back down the floor and out of the entrance way. (See figure 23-11.)

e. As the last trumpeter clears the entranceway, the doors are closed, thus concluding the ceremony.

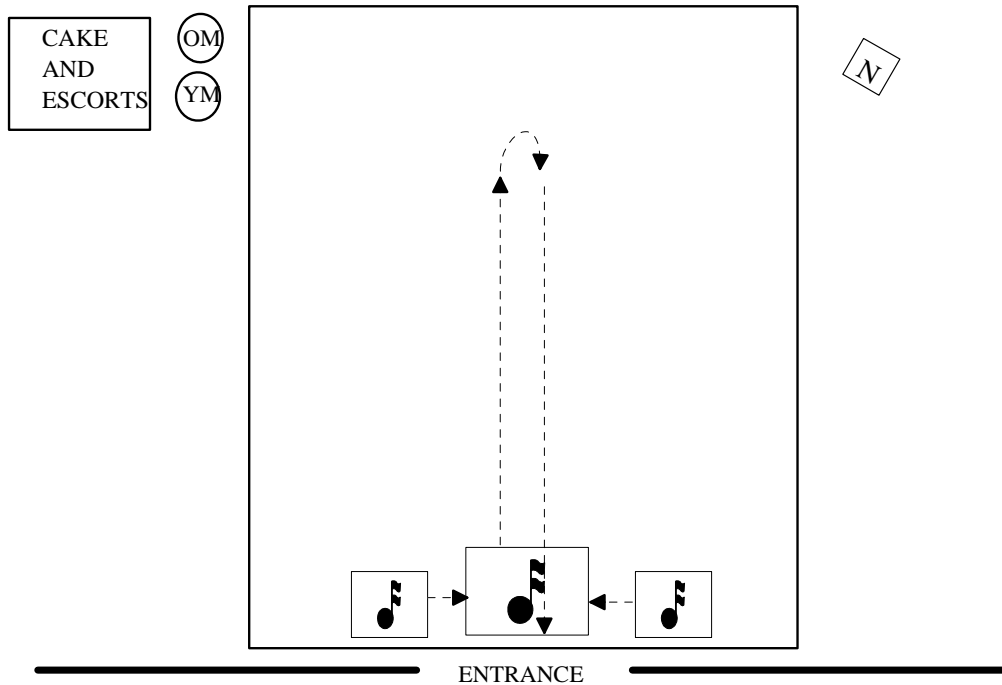

Figure 23-11.--Movements of the Drummers and Trumpeters During the March Off.

NARRATOR: "LADIES AND GENTLEMEN THAT CONCLUDES OUR CEREMONY. PLEASE ENJOY YOUR EVENING. THANK YOU."

Note: In the case where no general officer is in attendance substitute one of the following for the term "commanding general."

Unit/Officer's Ball	"Commanding Officer"
SNCO Ball	The rank of the senior enlisted present
Enlisted Ball	"Ball Committee Chairman"

→ 23004. VARIATIONS. It is recognized that considerable variation must be made in this ceremony to conform to the configuration of the dance floor or the absence of a band. Examples are:

Enclosure (1)

1. When the ceremony is conducted at posts where there is no general officer commanding, the senior line officer will follow the procedure outlined above for the commanding general. At such posts the escorts will be formed from the appropriate ranks present and the line of general officers will be deleted.
2. When the ceremony is conducted at noncommissioned officers or other enlisted messes, appropriate ranking noncommissioned officers will preside and form the escort.
3. Where the ballroom is of sufficient size, two officers or enlisted Marines of each rank will be assigned to the escort.
4. Where practicable, the Blue Dress "A," "B" or Service "A" will be worn by those officers and Marines participating in the ceremony.
5. Officers and noncommissioned officers participating in the ceremony should be armed with swords; however, at no time will Marines in the grade of LCpl through Pvt be armed with a sword. If the ceremony is conducted in utilities because of field duty, deployment, etc., the sword will not be worn.
6. The birthday cake will be mounted on a mess serving cart or similar conveyance covered with scarlet and gold bunting.
7. Where swords are not available, escorts will execute a hand salute whenever the command of "**Present, ARMS**" is given.
8. Guests may be cleared from the center of the ballroom by stretching white lines, supported by second lieutenants or noncommissioned officer, moving from the center line of the dance floor toward either side to provide required space for the ceremony.

23005. RECOMMENDED PERSONNEL ASSIGNMENTS

1. The number of officers and Marines assigned to be escorts will depend on the number of personnel available to the command and the space available to conduct the ceremony. The following are some examples of the composition of the escorts.

<u>OFFICERS BALL</u>				<u>STAFF NONCOMMISSIONED OFFICERS BALL</u>			
<u>Option A</u>		<u>Option B</u>		<u>Option A</u>		<u>Option B</u>	
Col	Col	Col	LtCol	SgtMaj	SgtMaj	SgtMaj	MGySgt
LtCol	LtCol	Maj	Capt	MGySgt	MGySgt	1stSgt	MSgt
Maj	Maj	1stLt	2ndLt	1stSgt	1stSgt	GySgt	SSgt
Capt	Capt	CWO	CWO	MSgt	MSgt		
1stLt	1stLt			GySgt	GySgt		
2ndLt	2ndLt			SSgt	SSgt		
CWO5	CWO5						
CWO4	CWO4						
CWO3	CWO3						
CWO2	CWO2						
WO1	WO1						

UNIT/ALL RANKS BALL

Col	LtCol
Maj	Capt
1stLt	2ndLt
CWO	CWO
SgtMaj	MGySgt
1stSgt	MSgt
GySgt	SSgt
Sgt	Cpl
LCpl*	PFC*
Pvt*	Pvt*

ENLISTED BALL

Sgt	Sgt
Cpl	Cpl
LCpl*	LCpl*
PFC*	PFC*

2. The adjutant should be assigned as follows:

BALL

Officers or all ranks
Staff Noncommissioned Officer
Enlisted

ADJUTANT ASSIGNED

Major or Captain
Gunnery Sergeant or Staff Sergeant
Sergeant or Corporal

3. Cake escorts should be assigned as follows:

Officers Ball

2ndLt	2ndLt
WO1	WO1

SNCO Ball

GySgt	GySgt
SSgt	SSgt

Enlisted Ball

PFC	PFC
Pvt*	Pvt*

Unit/All Hands Ball

2ndLt	SSgt
WO1	Pvt*

*Marines in the grades of LCpl, PFC, and Pvt are never armed with a sword.

MARINE CORPS DRILL AND CEREMONIES MANUAL

PART II: CEREMONIES

CHAPTER 24

MESS NIGHT

	<u>PARAGRAPH</u>	<u>PAGE</u>
GENERAL	24000	24-3
SCHEDULE OF EVENTS	24001	24-3
SEQUENCE	24002	24-4

PART II: CEREMONIES

CHAPTER 24

MESS NIGHT

24000. GENERAL

1. It has long been an established custom of the officers and/or noncommissioned officers of a military organization to dine together periodically. A mess night is a formal dinner in mess by all members, or by the officers and noncommissioned officers of a particular post or unit. It is sometimes called a "Guest Night" or a "Dining-in" and less commonly as a "Formal Mess Dinner" or "Band Night." The mess night is a formal stag dinner where spouses and dates do not attend. The object of a mess night may vary from a wish to foster good comradeship among fellow Marines, to celebrate the anniversary of significant events in a units history, to "dine-out" members being detached, or to honor guests from another unit, service or country.

2. The procedures for a mess night outlined in this Chapter are to be used as a guide. Commanders may modify these procedures to accommodate local requirements and restrictions. In addition to the information contained in this Chapter, additional guidance concerning invitations, seating and protocol may be found in appendix D, in Oretha D. Swartz's *Service Etiquette the Marine Officer's Guide*, fourth edition, and *Handbook for Marine Noncommissioned Officers* published by the Naval Institute Press.

24001. SCHEDULE OF EVENTS. Drawing upon our history and traditions, the following general routine is a standard guideline for Mess Nights, subject to modification as required.

- 1. Key personnel arrive and supervise last minute preparations.
- 2. Members of the mess arrive, the bar is opened and the cocktail hour begins. This is normally 45 minutes before dinner.
- 3. Guest of honor arrives and is met by the escort.
- 4. Fifteen minutes prior to dinner, "*First Call*" or "*Dinner Chimes*" is sounded. At this time all present finish their drinks, make final head calls (since no one will be excused from the dining room during the dinner without permission from the Mess President), and begin assembling for the march on. No drinks or tobacco are to be carried into the dining area.
- 5. Five minutes prior to dinner, "*Officers Call*" is sounded ("*First Sergeant's Call*" is sounded at an enlisted mess). All members form in the order they are to be seated. The official party, who occupies the head table, is the last unit to form and enter the mess. At this time, the smoking lamp is out.
- 6. At the appointed time the drum and trumpet detail plays "*Sea Soldiers*" as the members of the mess march on. Members of the mess march smartly to their assigned seats and remain standing while the entire mess assembles. The official party enters smartly and moves to their assigned position at the head table as "*Semper Fidelis*" is played. When the head table is occupied, the music ceases. All hands remain standing for the grace.

Enclosure (1)

smartly as "*Semper Fidelis*" is played and moves to their assigned position at the head table. When the head table is occupied, the field music ceases, executes the prescribed facing movements, and marches out of the dining room to a single drumbeat. All hands remain standing for the grace.

7. Grace is offered. Either a chaplain, President of the Mess, or Mr./Madam Vice does this.

8. Dinner is served, after the last of the wine and soup is removed, "Parade the Beef."

9. "Shed a Tear." It is optional at the end of the meal to allow a break.

10. Port is served and the smoking lamp lighted. It is customary at this time to open the floor to fining although this may be omitted or done at a different time.

11. Mess President remarks.

12. Introduction of guests and remarks by the guest of honor.

13. Toasting.

14. Secure from the dining room and move to the bar.

15. After dinner activities.

24002. SEQUENCE. This sequence of events is a summation of the night activities, a "refresher" outline for what takes place at a mess night. Times are given for the events prior to and after the meal. Events during the meal are not regulated by time. The following is an example of a mess night sequence.

- 1. The President and Mr./Madam Vice have verified that all arrangements have been made and are standing by to begin the cocktail hour.
- 2. Members of the mess begin arriving prior to the guests. Cash bar provided. Members are reminded to consult the seating chart.
- 3. H Hour-60 Minutes. Cocktail hour begins and guests begin arriving. Guest of honor arrives. All are met by Mr./Madam Vice and introduced to the mess president and members of the mess.
- 4. H Hour-15 Minutes. "*First Call*" or "*Dinner Chimes*" is sounded. All present finish drinks, make final head calls, and begin assembling for the march on.
- 5. H Hour-5 Minutes. Assemble. "*Officer's Call*" or "*First Sergeant's Call*" is sounded. All members assemble [to include any guests] in the order they are to be seated and stand by for the march on. The head table forms last and enters separately.
- 6. H-Hour. March on. Mr./Madam Vice commands "**Forward, MARCH.**" As the members step off, "*Sea Soldiers*" is played. Members and guests march to their place and stand behind their chairs. Once all are in place and the music stops, Mr./Madam President commands "**Forward, MARCH**" for the head table. As the head table steps off, "*Semper Fidelis*" plays. Once the head table is in place the music stops and all remain standing.

Enclosure (1)

7. Mr./Madam Vice: **"Mr./Madam President, all members of the mess and guests are present."**
8. Mr./Madam President: **"Chaplain, offer the grace."** (Note if a chaplain is not present then either Mr./Madam President or Mr./Madam Vice may offer grace.)
9. Mr./Madam President: ***Raps the gavel once*** and states **"Please be seated."** The members will wait until the head table is seated and then sit. Appetizer is served (e.g., shrimp cocktail, salad) and after the last of the soup bowls and glasses are removed the next course will start. Members will not begin eating each course until after the President and guest start.
10. The President stands, ***raps the gavel three times*** and states **"Mr./Madam Vice, bring forth the beef."**
11. Mr./Madam Vice: **"Chief Steward, the beef."** At this time the music "*Roast Beef of Old England*" is played. Mr./Madam Vice accompanies the chief steward to the head table, is handed a small portion of beef and passes it to the President who tastes it.
12. Mr./Madam President: **"I find this beef tasty and declare it fit for human consumption. Please serve the members of the mess."** The beef is removed to the galley for serving. The music "*Roast Beef of Old England*" is played as the beef is removed. The dinner continues until after dessert is finished.

Note: If the mess night is to include fining, the floor may be opened to fining once the main course is served or as an option once the smoking lamp is lighted. The President will close the floor for fining whenever the Marine deems fit.
13. After dessert is finished and while the servers are clearing the table it is optional to allow the members of the mess a short break and make head calls.
 - a. Mr./Madam Vice: After dinner, stands and requests **"Mr./Madam President, I suggest we shed a tear for Lord Admiral Nelson."**
 - b. Mr./Madam President: ***Raps the gavel twice*** (mess stands). **"The mess will adjourn for a 15-minute break."** The official party departs followed by all others. Do not return until called.
 - c. During the break Mr./Madam Vice will ensure that coffee, cigars, ashtrays, matches, and wine for toasting is placed on the tables.
 - d. After 15 minutes and on cue from Mr./Madam Vice, the music "*First Call*" is played. All members and guests return and stand behind their seats. Once all members and guests have returned to their chairs the head table will march in.
14. Mr./Madam Vice: **"Mr./Madam President, all members and guests of the mess are present."** or **"Mr./Madam President, all members and guests of the mess are not present. Name the offenders."**
15. Mr./Madam President: ***Raps gavel once***. "Please be seated" ***Raps gavel three times***. **"Mr./Madam Vice, the smoking lamp."** After Mr./Madam Vice has brought forth the smoking lamp and lighted the cigars of Mr./Madam President, the President announces **"Ladies and Gentlemen, the smoking lamp is lighted."**
16. Mr./Madam President: ***Raps gavel three times***. **"Mr./Madam Vice bring forth the wine for toasting."**

17. Mr./Madam Vice: **"Chief Steward, the wine."** Mr./Madam Vice accompanies the chief steward and pores the wine for the guest of honor and Mr./Madam President. When all glasses are charged, Mr./Madam Vice stands and announces **"Mr./Madam President, all glasses are charged,"** and remains standing.
18. Mr./Madam President: Stands and **raps gavel three times**. Takes wine glass in right hand and announces **"Mr./Madam Vice, a toast to the Commander and Chief, the President of the United States."** If foreign guests are present then the first toast is given to the head of state of that guest and any others in order of seniority. The senior foreign guest would then toast the President of the United States. Appropriate music is played for all foreign heads of state and the *"National Anthem"* played after toasting the President of the United States.
19. Mr./Madam President: Stands and **raps gavel three times**, moves to podium. At this point Mr./Madam President makes opening remarks followed by the introduction of the guests of the mess. Once the guests are introduced Mr./Madam President introduces the guest of honor.
- a. **"Ladies and Gentlemen, it is my personal pleasure and professional privilege to introduce our guest of honor, _____."**
 - b. Remarks by guest of honor.
 - c. Presentation of memento to guest of honor.
20. Mr./Madam President: Stands and **raps gavel three times**. **"The floor is now open for toasting."** At this time official, traditional and personal toasts are made per paragraph D-7 and local custom. At most mess nights, the toasts are prearranged to include the loyalty toast, the traditional toast, and the toast to our fallen comrades and a toast to Country and Corps. The toasts are given in the following manner; each Marine selected for a particular toast will stand with glass in right hand, faces Mr./Madam Vice, and states:
- a. _____, **"Mr./Madam Vice, (Mr./Madam Vice stands), A toast to the Continental Marines who fought for freedom and liberty."** Mr./Madam Vice will state, **"Ladies and Gentlemen, a toast (all members stand with wine glasses in right hand), to the Continental Marines."** All members raise their glasses, repeat in unison the words of Mr./Madam Vice, **"To the Continental Marines"** drink a portion of their wine, and resume their seats. This sequence is followed for each toast.
 - b. _____, **"Mr./Madam Vice, A toast to the Marines of the 19th century who fought from the halls of Montezuma to the shores of Tripoli."** Mr./Madam Vice: **"Ladies and Gentlemen, A toast to the Marines of the 19th century."** Mess: **"To the Marines of the 19th century."**
 - c. _____, **"Mr./Madam Vice, A toast to the Marines of World War I who fought from the Argonne Forest to Belleau Wood."** Mr./Madam Vice: **"Ladies and Gentlemen, A toast to the Marines of World War I."** Mess: **"To the Marines of World War I."**
 - d. _____, **"Mr./Madam Vice, A toast to the Marines who fought in the Island campaigns of World War II, where uncommon valor was a common virtue."** Mr./Madam Vice: **"Ladies and Gentlemen, A toast to the Marines of World War II."** Mess: **"To the Marines of World War II."**

e. _____, "Mr./Madam Vice, A toast to the Marines who fought in Korea from Inchon to the Chosin Reservoir." Mr./Madam Vice: "Ladies and Gentlemen, A toast to the Marines who fought in Korea." Mess: "To the Marines who fought in Korea."

f. _____, "Mr./Madam Vice, A toast to the Marines who fought for freedom in Vietnam." Mr./Madam Vice: "Ladies and Gentlemen, A toast to the Marines who fought in Vietnam." Mess: "To the Marines who fought in Vietnam."

g. _____, "Mr./Madam Vice, A toast to the Marines who fought oppression in Lebanon and Grenada." Mr./Madam Vice: "Ladies and Gentlemen, A toast to the Marines who fought oppression in Lebanon and Grenada." Mess: "To the Marines of Lebanon and Grenada."

h. _____, "Mr./Madam Vice, A toast to the Marines who fought for Kuwait liberty in Southwest Asia." Mr./Madam Vice: "Ladies and Gentlemen, A toast to the Marines of Desert Shield and Desert Storm." Mess: "To the Marines of Desert Shield and Desert Storm."

i. _____, "Mr./Madam Vice, A toast to our comrades in arms, the United States Navy Corpsmen." Mr./Madam Vice: "Ladies and Gentlemen, A toast to our comrades in arms, the United States Navy Corpsmen." Mess: "To Navy Corpsmen."

Note: This toast may be omitted if the toast to the United States Navy is done during the official toasts.

j. _____, "Mr./Madam Vice, A toast to the Marines currently deployed on the forward edge of our Nation's defense." Mr./Madam Vice: "Ladies and Gentlemen, A toast to Marines currently deployed." Mess: "To Marines currently deployed."

k. In place of the above toasts the procedures outlined in paragraph D-7.7h can be used. During the above sequence the appropriate toasts to other services will be inserted as directed by the President of the Mess.

l. Mr./Madam Vice: "I to have a toast; as you entered this banquet hall, you should have noticed that before us tonight stands an empty chair and a single lone table draped in black, signifying all of our fallen comrades who are not with us this evening, because they have given the full measure of devotion to our Country and to our beloved Corps. The single lighted candle reminds us of the flame of eternal life. That the memory of our fallen comrades will be with us always. The Purple Heart Medal displayed to reflect the shedding of blood and the ebb of life in battle. The identification tags, blank, yet they could bear the name of any of us here tonight. The dinner setting, inverted, they break bread with us in spirit only. Ladies and Gentlemen a toast, To our fallen comrades." Mess: "To our fallen comrades." "TAPS" is played.

21. At this time the President can make appropriate remarks concerning business of the mess to include hail and farewell of members, recent promotions, etc.

22. Mr./Madam President: "Mr./Madam Vice, bring forth the rum punch." Mr./Madam Vice uses the same procedures as for wine and remains standing throughout.

23. Mr./Madam Vice: After all glasses are charged states **"Mr./Madam President, all glasses are charged."**
24. Mr./Madam President: **"In 1776, one of the first recruiting posters ordered recruits upon enlistment, take courage then, seize the fortune that awaits you, repair to the Marine rendezvous, where in a flowing bowl of punch, and three times three you shall drink (pause), long live the United States and success to the Marines. Mr./Madam Vice, a toast to the country and Corps."**
25. Mr./Madam Vice: **"Ladies and Gentlemen, a toast, long live the United States and success to the Marines."** Mess: All repeat, glasses are emptied and inverted. *"Marine's Hymn"* is played. It is more appropriate at this time to have the mess sing all three versus of the Marine's Hymn.
26. Mr./Madam Vice: Ensures those who prepared and served the meal are present and standing behind Mr./Madam Vice's table.
27. Mr./Madam President: ***Raps gavel three times.*** **"Ladies and Gentlemen, join me in a round of applause for the staff who have prepared and served the meal and drinks in honor of our mess this evening and which we have enjoyed."** (Leads applause.)
28. Mr./Madam President: ***Raps gavel three times.*** **"Ladies and Gentlemen, join me at the bar."** Members remain standing until the head table has departed.

MARINE CORPS DRILL AND CEREMONIES MANUAL

PART II: CEREMONIES

CHAPTER 25

FUNERALS AND MEMORIAL SERVICES

	<u>PARAGRAPH</u>	<u>PAGE</u>
GENERAL	25000	25-3
DUTIES OF THE OFFICER IN CHARGE OF THE CEREMONY	25001	25-5
RECEIVING THE REMAINS	25002	25-7
PROCESSION	25003	25-10
AT THE GRAVE	25004	25-13
MEMORIAL SERVICE HONORS	25005	25-17
CONDUCT OF FUNERALS WHEN MILITARY PERSONNEL ARE LIMITED	25006	25-19
UNIT OUTDOOR MEMORIAL SERVICES WHEN REMAINS ARE INTERNEED AT DECEASED HOME OF RECORD	25007	25-19
UNIT INDOOR MEMORIAL SERVICES WHEN REMAINS ARE INTERNEED AT DECEASED HOME OF RECORD	25008	25-21

FIGURE

25-1	RECEIVING THE REMAINS FROM A BUILDING	25-6
25-2a	PALLBEARS ENTERING; LEAVING THE CHAPEL	25-7
25-2b	ENTERING CHAPEL; LEAVING CHAPEL	25-8
25-3	RECEIVING REMAINS AT CEMETERY GATES (TRANSFERRING REMAINS FROM HEARSE OR CAISSON)	25-9
25-4	ORDER OF MARCH OF FUNERAL PROCESSION	25-12
25-5	RECEIVING THE REMAINS AT THE BURIAL GROUND	25-14
25-6	MARCH TO THE GRAVE	25-15
25-7	A DISTRIBUTION OF UNITS AT THE GRAVE	25-16
25-8	HONOR GUARD	25-18
25-9	COMPANY MEMORIAL FORMATION	25-21

MARINE CORPS DRILL AND CEREMONIES MANUAL

PART II: CEREMONIES

CHAPTER 25

FUNERALS AND MEMORIAL SERVICES

25000. GENERAL

1. When not contrary to orders and regulations, the extent to which the Naval service participates in a funeral depends upon the expressed wishes of the family of the deceased.
2. The composition and strength of the escort will be as prescribed in *U.S. Navy Regulations* or as modified by proper authority.
3. The military aspect of a funeral usually begins at one of the following places, home of the deceased, mortuary, railroad station, church or chapel, cemetery gates, or the grave. It may, however, begin at any designated place.
4. The ceremony starts when the escort first receives the remains. Before that, the body bearers may be detailed to conduct the remains wherever necessary.
5. In general, the escort receives the body at one of the following places:
 - a. The designated place and conducts it to the place of services and then to the grave.
 - b. The chapel before, and conducts it to the grave after the services.
 - c. The cemetery gates and conducts it to the grave.
 - d. The grave.
6. Each time the body bearers remove the remains:
 - a. The escort is brought to present arms.
 - b. The band renders prescribed honors, followed by appropriate music.
 - c. The pallbearers salute.
 - d. All observers in uniform, except the body bearers, salute.
 - e. All civilian-dressed Naval personnel, except women, uncover and hold the headdress over the heart with the right hand. Women place the right hand over the heart without uncovering.
7. When the national colors is draped on the casket, it shall be placed so the stars are at the head of the casket over the left shoulder of the deceased. Nothing shall rest on top of the national colors. The colors will be removed as the casket is being lowered into the grave, and in time so the colors will not touch the ground.
8. The casket is always carried foot first, except in the case of a clergyman whose casket is carried into and out of the church or chapel head first.

9. Pallbearers may walk or ride, depending upon the distance to be covered.
10. The senior pallbearer will give necessary cautionary commands to the others in a low voice. All salute at the command "**Present, ARMS**" when given by the escort commander.
11. The personal flag of a deceased general or flag officer will be carried immediately in front of the hearse or caisson. If he was a unit commander or ship's captain, the command or commission pennant will also be carried.
12. If the entrance to the cemetery prevents the hearse or caisson from entering, the procession halts, the casket is removed, and the procession proceeds again.
13. When the deceased is entitled, the minute gun salute prescribed by *U.S. Navy Regulations* is fired. The first gun fires as the body enters the cemetery. Three volleys are fired at 5-second intervals as the casket is lowered into the grave.
14. When the band is playing a hymn and it becomes necessary to stop, it continues until the next stanza ends.
15. Uniformed officers in an official capacity will wear a mourning band on the left sleeve. If armed with the sword, its hilt will be affixed with the mourning knot.

Note: No weapons to include swords will be worn or brought into the chapel.

16. Participation by fraternal or patriotic organizations is as follows:
 - a. Fraternal or semi-military organizations of which the deceased was a member may participate in the service if desired by the immediate family.
 - b. If the ritual is military or semi-military, the rites will begin immediately after the military ceremony. If it includes the firing of three volleys and "*Taps*," these features of the military ceremony may be postponed until their appropriate places in the ritual, at which times the military firing party and bugler may render the honors.
17. When the body has been cremated, casket, body, and remains, as used herein, refer to the container of the ashes.
 - a. For all phases of the funeral in which the cremated remains are carried by hand, one enlisted man will be detailed to carry the receptacle. Four enlisted men will be detailed as flag bearers. When the receptacle is carried from a conveyance into the chapel, from the chapel to the conveyance, or from the conveyance to the grave, the flag bearers will follow the receptacle with the flag folded as prescribed in paragraph 7002.6 and carried by the leading flag bearer on the right.
 - b. When the receptacle has been placed on the stand before the chancel of the chapel, or when placed in the conveyance, the flag will be folded and placed inside it. If the caisson is equipped with a casket container for the receptacle, the open flag will be laid on the container as prescribed for a casket.

c. When a hearse or caisson is not used, suitable transportation will be provided the receptacle bearer and flag bearers.

d. When the remains are to be conducted to a crematory and the ashes interred with military honors at a later time, the ceremony will consist only of the escort to the crematory. Arms will be presented as the body is carried into the crematory. Volley firing and "Taps" are omitted. If the funeral is held at the crematory and no further military honors are anticipated, the volleys will be fired (if local ordinances permit) and "Taps" sounded outside the crematory.

25001. DUTIES OF THE OFFICER IN CHARGE OF THE CEREMONY

1. The officer in charge should be detailed in sufficient time before the funeral to allow planning and prior arrangements. The officer in charge will confer with the clergy and funeral director. Together they will ensure that all necessary arrangements have been made. The chaplain will perform the duties of officer in charge of the ceremony in case no other officer is so designated.

2. As soon as the service in the church or chapel has begun, the officer in charge will:

a. Make sure the hearse or caisson is ready to receive the casket at the front entrance.

b. Ensure a conveyance for flowers is posted at the side or rear-entrance.

c. Arrange the cars for the clergy, pallbearers, and immediate family (if the procession is to ride) in the proper order. (See figure 25-1.)

d. Designate four of the body bearers to help carry the flowers out after the body has been placed in the conveyance. They should return through the side or rear door, at whichever the flower conveyance is parked. The remaining body bearers will secure the casket on the caisson or hearse. After the flowers have been moved, the four designated body bearers will take position in rear of the caisson or hearse.

3. When the body is transferred from the hearse to the caisson, the officer in charge will be in the vicinity. He will signal the escort commander when the transfer begins and when it is completed.

4. When the procession is in motion, the officer in charge will go to the grave and await the arrival of the funeral party. He will determine the positions for the band, escort, firing party (if separated from the escort), the bugler, and other units. Upon their arrival, he will direct these individuals and units to their proper positions at the grave.

5. After the units and individuals are in position at the grave, he will signal the body bearers to carry the remains from the conveyance and the band and escort to render the honors.

6. When the widow or mother of the deceased is unaccompanied, the officer in charge will escort her from the car to the grave. When practicable, he will remain with her to render assistance until completion of the commitment.

7. After the commitment service, he will deliver the folded national colors, used on the casket, to the family of the deceased.

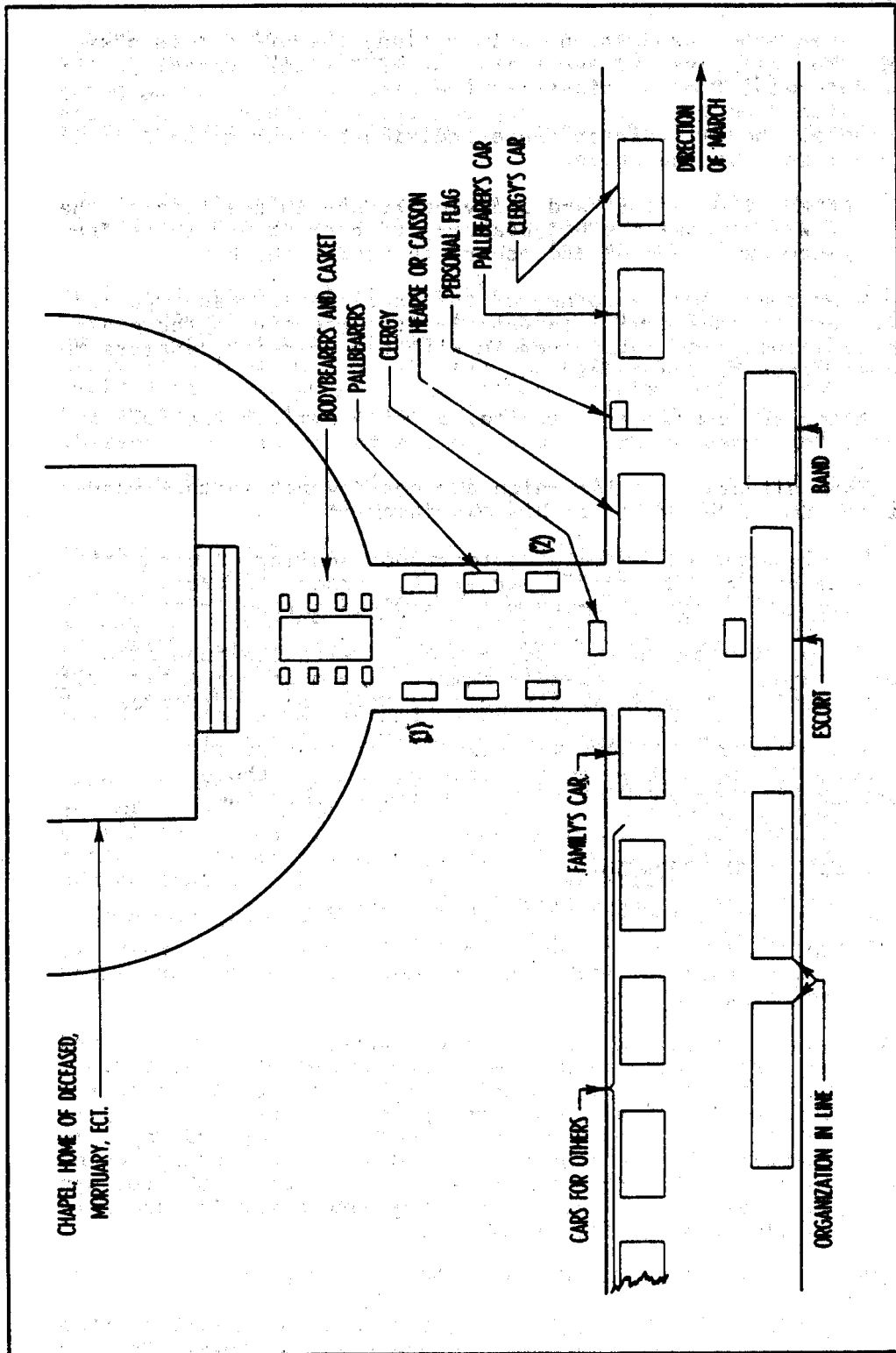

Figure 25-1.--Receiving the Remains from a Building.

8. When situations arise which are not covered in this Manual, the officer in charge will use his/her own judgment.
9. Final decisions pertaining to troop handling or movement will be made by the officer in charge. All orders to troops participating in a funeral party will be given through the officer in charge.
10. The officer in charge must cooperate with the funeral director engaged by the deceased's family. The officer in charge must not arbitrarily assume the duties the funeral director is being paid to perform.
11. The officer in charge will explain the nature and significance of the volleys to the next of kin, or those representing the next of kin, and ascertain whether the volleys are desired.

25002. RECEIVING THE REMAINS

1. Whenever the remains are received, the following procedure will govern. (See figures 25-1, 25-2, and 25-3.)



Figure 25-2a.--Pallbearers Entering; Leaving the Chapel.

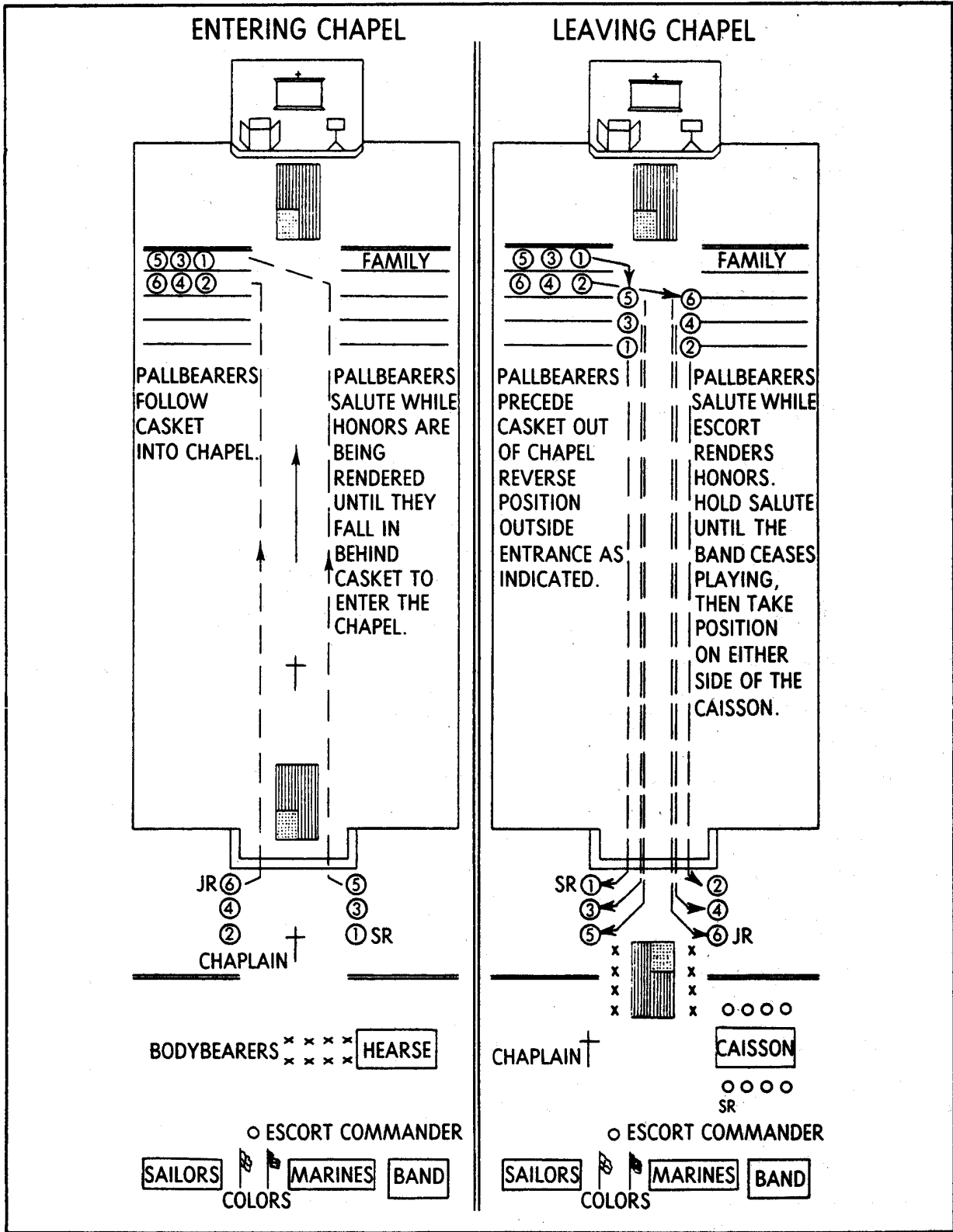

Figure 25-2b.--Entering Chapel; Leaving Chapel.

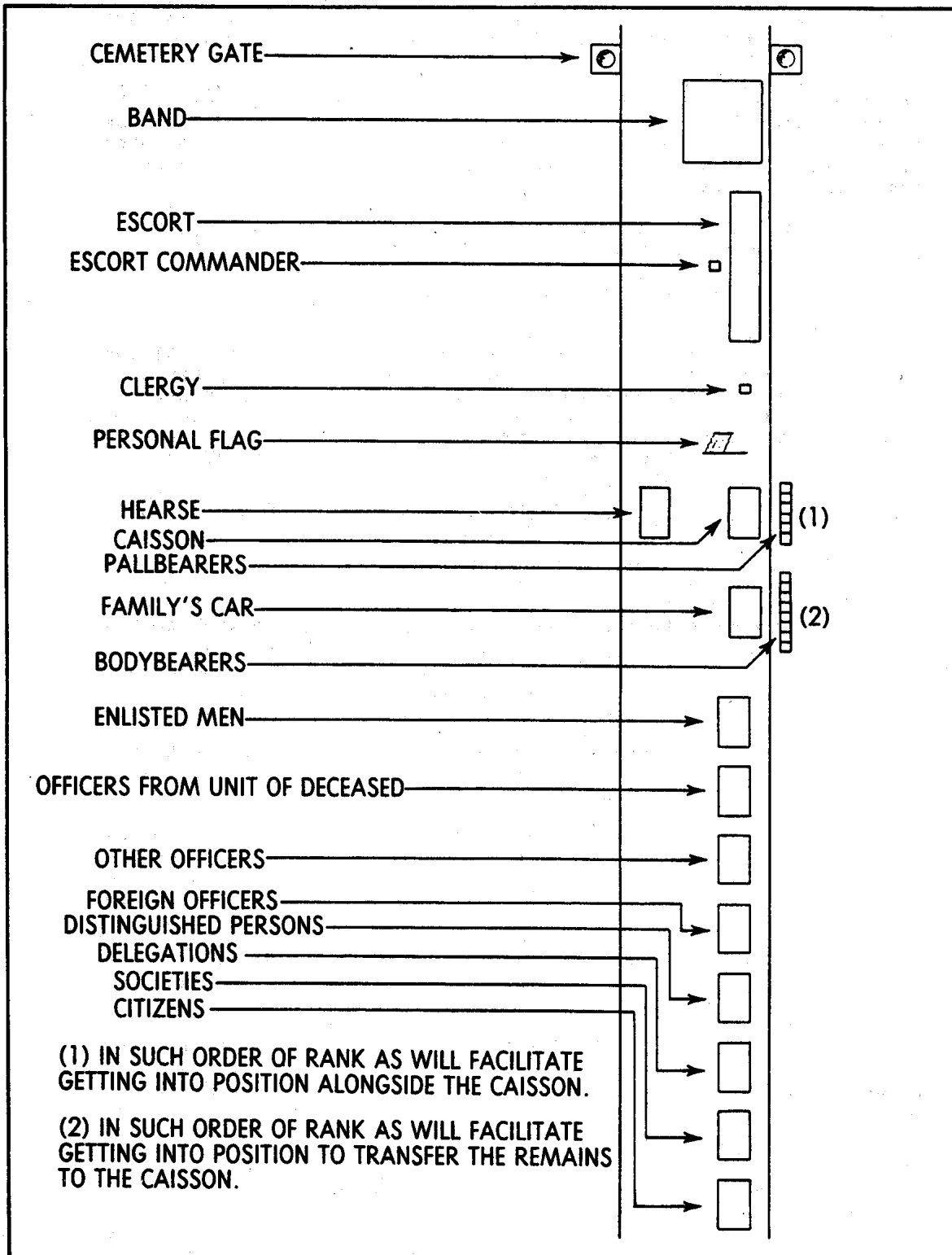

Figure 25-3.--Receiving Remains at Cemetery Gates
(Transferring Remains from Hearse or Caisson).

2. The escort is formed opposite the place where the remains are to be received. As they arrive, or when all is ready to receive the remains, the commander of the escort commands "**Present, ARMS.**" After the remains have been received, the door to the hearse is closed, or the casket secured to the caisson, and the escort commander orders "**Order, ARMS.**"

3. The band is formed on the flank toward which the escort is to march. At the command of execution for present arms by the escort commander, the band will render musical honors if the deceased is entitled to such honors. Following this, they play appropriate music; stopping at the next stanza ending after order arms has been ordered.

4. The bearer of the personal flag of the deceased takes position and marches in front of the hearse or caisson.

5. Duties of the pallbearers are as follows:

a. When the remains are received at the chapel before the service, form in two ranks facing inboard at the entrance with the juniors nearest the door. They must allow room between ranks for the casket to pass between them. As the casket is removed from the hearse or caisson, they execute the first movement of the hand salute. The second movement is executed as the casket passes, after which they face toward the door and follow the casket into the chapel. Seats are usually reserved for them among the left front pews.

b. When the remains are received from a building (see figure 25-1), assemble inside the building in column of twos, in reverse order of rank, junior to the left front, prepared to march out. They follow the clergy from the building (preceding the casket), open to allow the casket to pass between, halt, face inboard, and salute while the casket is passing. They remain at hand salute until the escort executes order arms. They then take their place in two columns of files on each side of the casket in inverse order of rank, junior to the left front, the leading person of each column opposite the front wheels of the hearse or caisson.

c. When the remains are received at the cemetery gates (see figure 25-3), they form in a single rank on the flank of the escort, opposite the hearse or caisson and in such order of rank that moving to position alongside the caisson is facilitated. They execute and terminate the hand salute on the commands for present and order arms by the escort commander. After present arms, they take their places beside the hearse or caisson as described in paragraph 25002.5b above.

6. The body bearers, if not already with the remains, form on the left of the pallbearers. They leave the formation at the proper time to receive the casket and carry it to the chapel, caisson, or grave. They form, according to height, on each side of the casket. While indoors and not carrying the casket, they uncover. Outdoors they remain covered.

25003. PROCESSION

1. After the remains have been placed in the hearse or caisson and all is ready, the officer in charge of the ceremony signals the escort commander. The escort commander puts the band and escort in motion. Elements in rear follow.

2. The procession forms in the following order: (See figure 25-4.)

- a. Escort commander.
 - b. Band or bugler.
 - c. Escort in suitable formation.
 - d. Clergy.
 - e. Pallbearers if riding.
 - f. Personal flag if rated.
 - g. Casket. If pallbearers are not riding, they form on either side of the hearse or caisson as described in paragraph 25002.5b. If the pallbearers ride, the body bearers take the place of the pallbearers.
 - h. Body bearers in column of twos behind the hearse or caisson.
 - i. Family of the deceased.
 - j. Enlisted men.
 - k. Officers from the ship or organization of the deceased, in inverse order of rank.
 - l. Other officers in inverse order of rank.
 - m. Foreign officers.
 - n. Distinguished persons.
 - o. Delegations.
 - p. Societies.
 - q. Citizens.
3. The procession marches in slow time to solemn music.

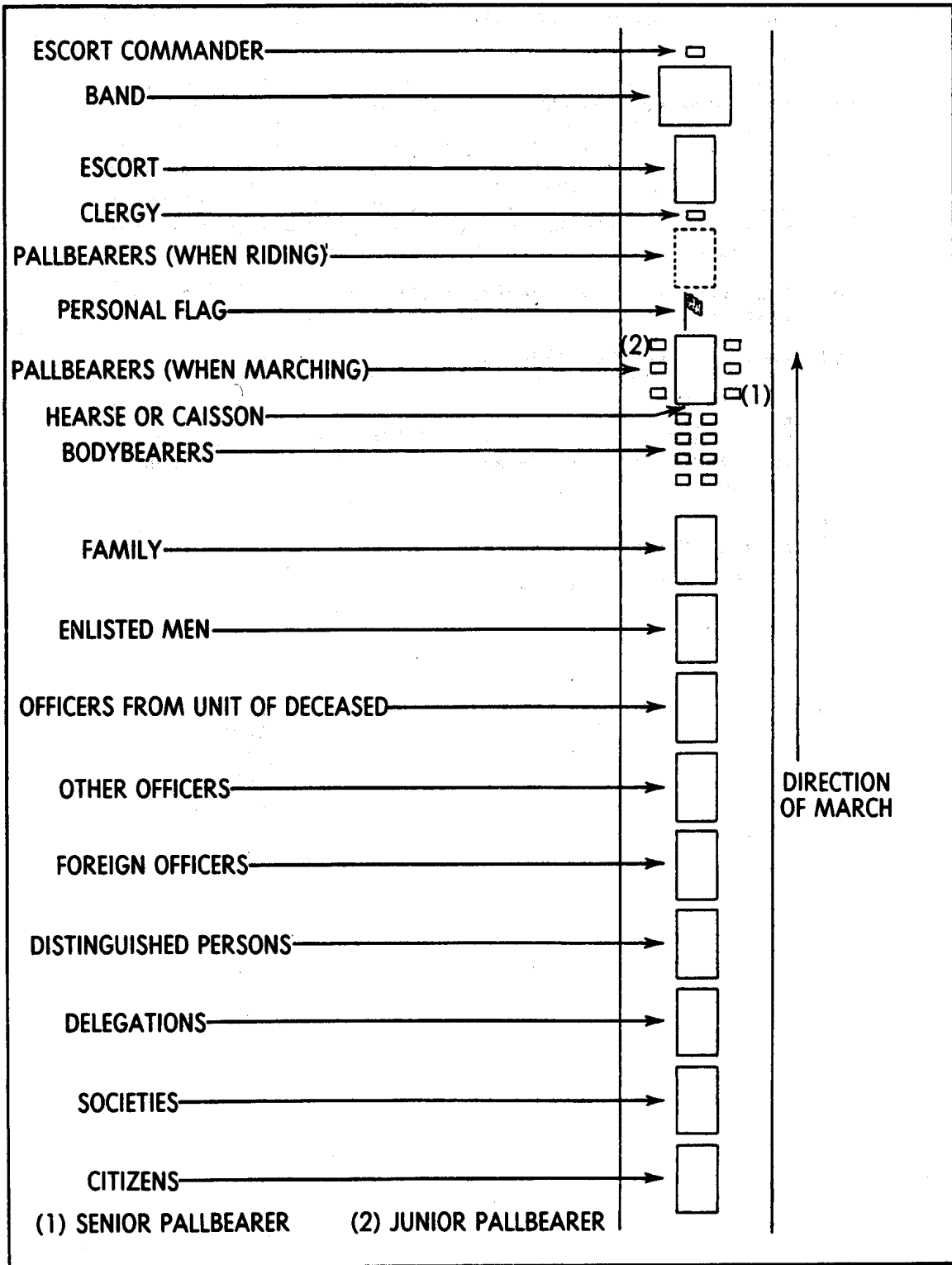

Figure 25-4.--Order of March of Funeral Procession.

25004. AT THE GRAVE

1. As the procession arrives at the grave, units turn out of column and take the following positions: (See figure 25-5.)
 - a. The band forms in line with and on the right of the escort.
 - b. The escort forms in line facing the grave at a position indicated by the officer in charge of the ceremony. It should be at least 50 feet from the grave so the volleys will not disturb the mourners. The terrain may dictate that the formation be inverted with the band on the left.
 - c. The clergy forms between the hearse or caisson and the grave.
 - d. The bearer of the personal flag of the deceased takes post between the clergy and the caisson or hearse.
 - e. The pallbearers form in two ranks between the clergy and the grave. They face each other with the juniors nearest the grave. They allow room between their ranks to permit passage of the casket.
 - f. The family of the deceased remains near the caisson or hearse.
 - g. Other units form in separate lines near and facing the grave. Their positions are indicated by the officer in charge of the ceremony.
2. When all units are in position and upon signal of the officer in charge of the ceremony, the body bearers remove the casket from the caisson or hearse. They carry it between the pallbearers and in front of the escort, then place it on the lowering device over the grave. They raise the national colors by the corners and sides and hold it waist or shoulder high until the end of the service.
3. As the body bearers remove the casket from the caisson or hearse: (See figure 25-6.)
 - a. The escort commander commands "**Present, ARMS.**" The band renders prescribed honors, if rated, after which they play appropriate music. The music stops when the casket is placed on the lowering device.
 - b. The escort presents arms until the casket is placed on the lowering device.
 - c. The clergy precedes the personal flag and the casket to the grave.
 - d. The flag bearer follows the clergy, preceding the casket, and takes position at the head of the grave. The flag bearer remains there during the service.
 - e. The pallbearers salute as the casket passes between them. When the casket has passed, they terminate the salute, face the grave, close interval, and follow the casket. Upon arrival at the grave, they form in two ranks facing the grave, usually just in rear and to one side of the clergy.
 - f. The family of the deceased follows the pallbearers and takes position provided for them.

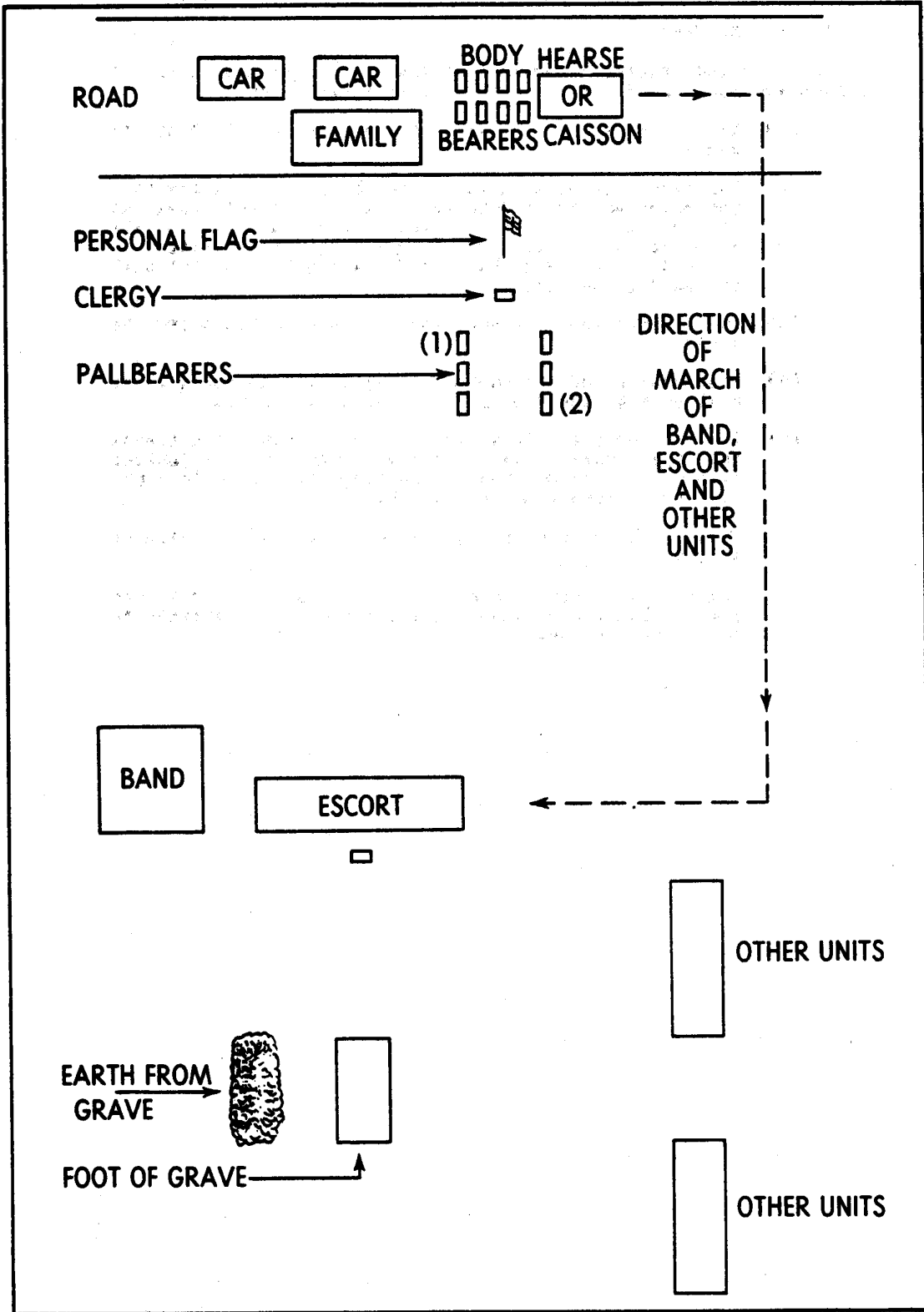

Figure 25-5.--Receiving the Remains at the Burial Ground.

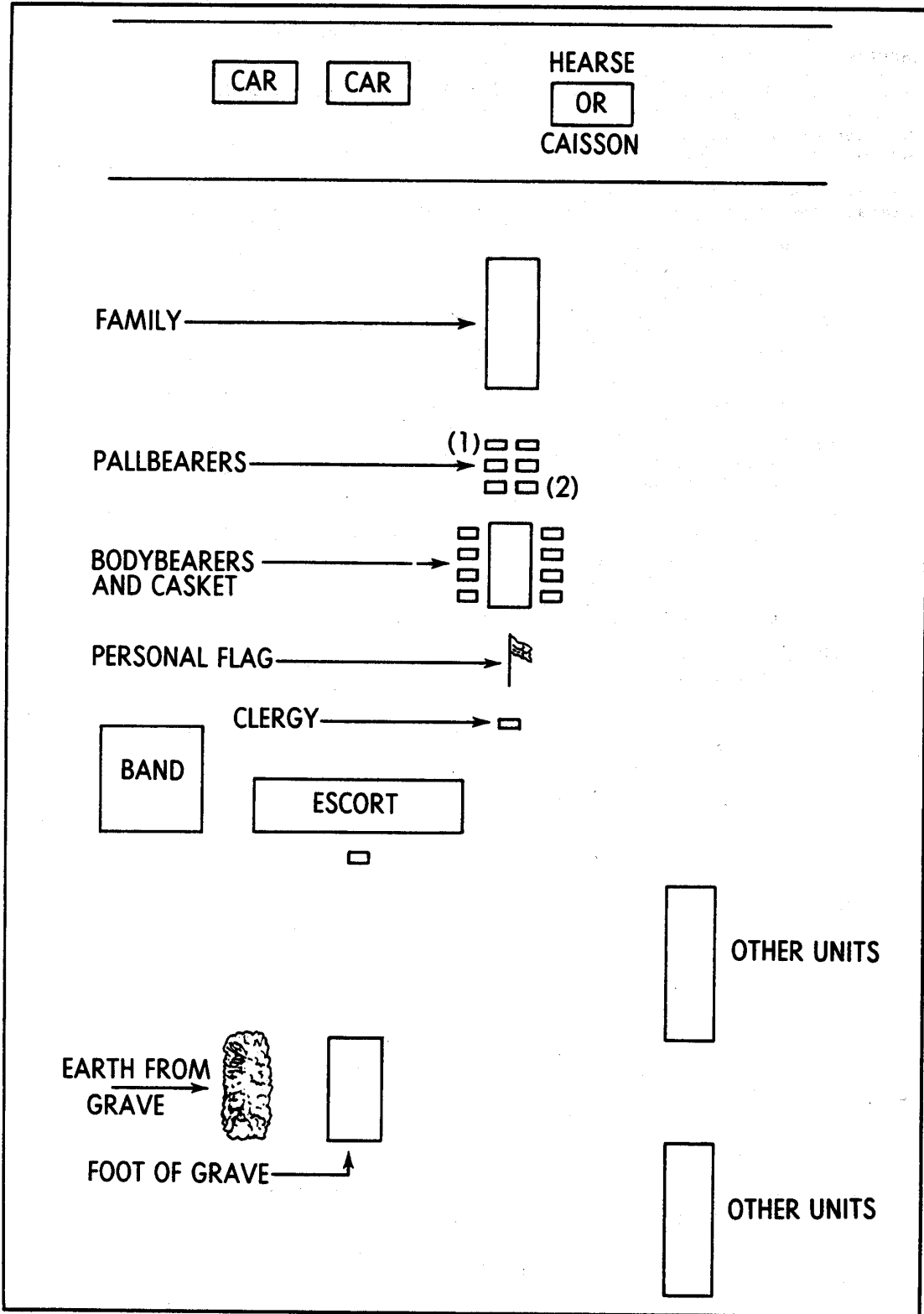

Figure 25-6.--March to the Grave.

4. When the casket is placed on the lowering device and the family has arrived, the following occurs: (See figure 25-7.)

- a. The escort commander orders "Order, ARMS" and "Parade, REST." Members of the escort execute parade rest.
- b. Pallbearers and other units execute parade rest on the escort commander's order.
- c. The body bearers remain in their positions, holding the national colors so it will not touch the ground when the casket is lowered.
- d. The clergy conducts the commitment service.

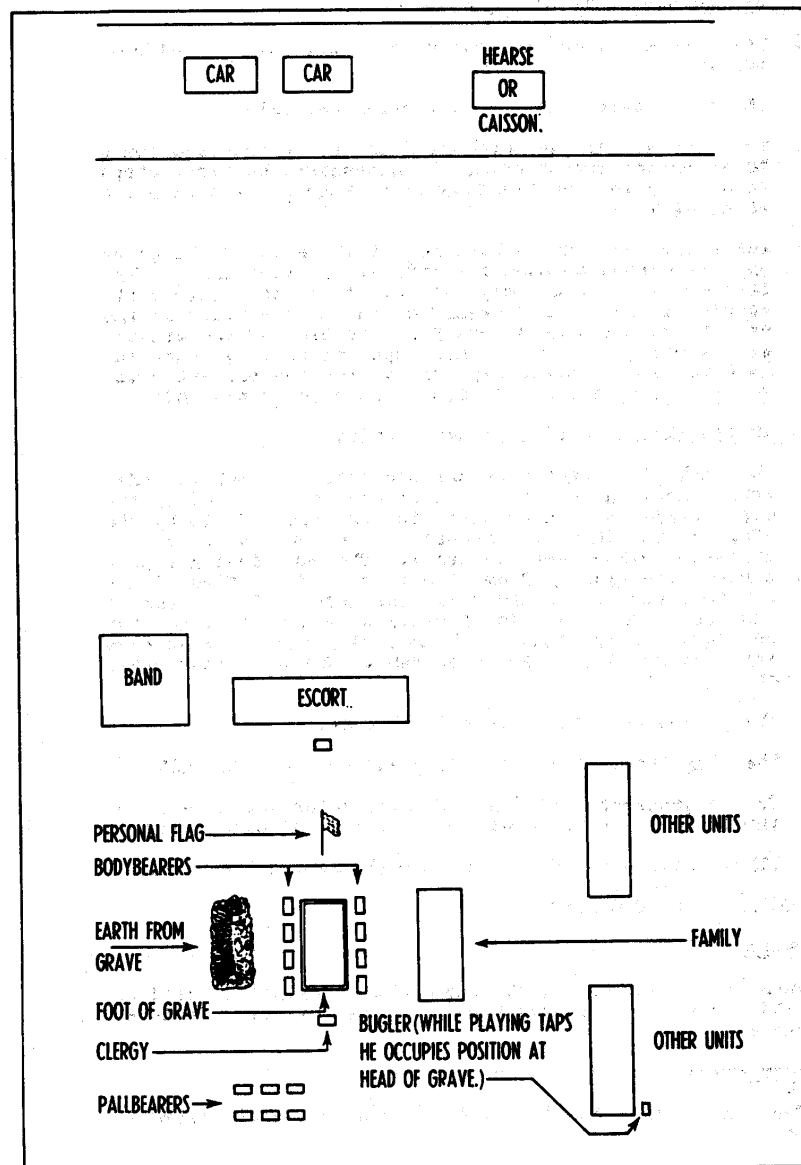

Figure 25-7.--A Distribution of Units at the Grave.

5. After the commitment service:

a. The escort commander orders "**Escort, ATTENTION,**" the escort commander then commands "**Escort, Present, ARMS.**" The noncommissioned officer in charge of the firing party then gives the command (see chapter 26) for the firing of volleys. The firing party executes present arms after completion of the three volleys. When sufficient troops are not available for a separate firing party, the front squad of the escort will be designated as the firing party.

b. The pallbearers come to attention on the command of the escort commander and salute on the Marine's command for present arms.

c. Other units are brought to attention and present arms at the same time as the escorts.

d. The clergy come to attention, and if in uniform, salute.

e. The bandleader comes to attention and salutes.

→ f. The bearer of the personal flag of the deceased comes to attention and salutes. If necessary, the Marine first steps aside to allow the bugler to take position for sounding "*Taps.*"

→ g. The bugler takes position at the head of the grave on the escort commander's order to present arms. (The officer in charge may direct that the bugler assume a position forward of and to the flank of the escort rather than directly at the head of the grave). The Marine salutes, and then sounds "*Taps*" immediately after the last volley and the firing party executes present arms. The bugler salutes again, faces about, and rejoins his/her unit.

6. After the last note of "*Taps*" has sounded:

a. The escort commander brings the entire escort to order arms, and after the colors has been folded by the body bearers and presented to the next of kin by the officer in charge, marches the escort and band to a suitable place for dismissal. The band does not play during the march from the grave. The firing party's weapons are unloaded and inspected. If the escort and band continue in formation after cemetery, they remove all mourning and muffling from any colors that may be present. The band then plays march music. Mourning and muffling includes the removal of mourning streamers and bunting from all colors, removal of mourning bands and mourning knots from personnel and swords, and the removal of muffling devices from band instruments.

b. The pallbearers fall out and withdraw.

c. The flag bearer folds the flag and rejoins his/her unit.

d. The body bearers fold the national colors and give it to the officer in charge of the ceremony and march away.

e. Other units march from the vicinity behind the escort.

25005. MEMORIAL SERVICE HONORS

1. Upon the request of the next of kin, memorial services will be held for Naval personnel whose remains have been declared non-recoverable.

Enclosure (1)

- 2. An honor guard is assigned and shall consist of the personnel listed in figure 25-8.

MEMBERS	FULL HONORS (OFFICERS ONLY)	HONORS (ENLISTED, OFFICERS IF SO REQUESTED)
SQUAD LEADER	1	
SQUAD	12	
COLOR GUARD	4	4
BUGLER	1	1
OFFICER IN CHARGE (REPRESENTATIVE OF THE NAVAL DISTRICT COMMANDANT OR DISTRICT MARINE OFFICER)	1	1
CHAPLAIN (IF REQUESTED)	1	1
COLOR BEARER	<u>1</u>	<u>1</u>
TOTAL	21	8

Figure 25-8.--Honor Guard.

3. The ceremony is conducted as follows:

a. The color bearer is present in the rear of the church or chapel before the arrival of the next of kin. At the exact time set for the service to begin (if next of kin has arrived), the color bearer carries the folded national colors down the center aisle to the altar. The Marine places it on the rostrum, where it remains throughout the ceremony, and retires to the wall on the left of the congregation. For the remainder of the service, the Marine stands at attention, facing inward, just in front of the first pew.

b. The honor guard, with color guard on their left, forms outside the church or chapel exit that will be used by the next of kin as the individual leaves. They remain at ease outside the church or chapel during the service. When "Taps" is sounded, they come to attention.

- c. The bugler takes position in the vestibule or other room, separate from the congregation.
- d. If requested by the next of kin, the chaplain conducts the service. Otherwise, the family minister or priest presides.
- e. At the conclusion of the service, the bugler sounds "Taps."
- The chaplain presents the national colors to the next of kin. If a family minister has officiated or the rank of the deceased requires, this duty is performed by the officer in charge.

Enclosure (1)

g. While presenting the flag, or after the flag has been presented by the chaplain the officer in charge pays respects and offers the condolences of the District Marine Officer. The chaplain speaks to the next of kin if he/she did not present the flag.

h. The officer in charge escorts the next of kin from the church or chapel.

i. The honor guard and color guard are called to attention by the squad leader (senior color bearer if squad is not present) upon the appearance of the next of kin. As the next of kin approaches to within 6 paces, the squad leader orders **"Present, ARMS."** The position of present arms is retained until the squad leader is directed to give order arms by the officer in charge. This will be after the next of kin has departed the vicinity.

j. All participating personnel are dismissed.

- 25006. CONDUCT OF FUNERALS WHEN MILITARY PERSONNEL ARE LIMITED. When personnel are limited, military honors for funerals may be efficiently rendered by a detail of eight Marines and one bugler. The firing squad will stack-arms at the place from which volleys will be fired, which should be approximately 50 feet from the head of the grave. They then will return to the hearse and convey the body to the grave. After placing the casket over the grave, six members of the party will take position as the firing squad while the remaining two members remain at the grave and hold the flag over the casket during the service and rendition of military honors. The bugler should take position approximately 50 feet from the head of the grave until the volleys have been fired, at the conclusion of which the Marine shall sound "*Taps*." Then the two members holding the flag shall fold it. The flag will be handed either to the Marine in charge of the detail or to the military escort commander. The escort commander will present it to the next of kin in a dignified manner with a short statement such as **"On behalf of the President, the Commandant of the Marine Corps, and Marines everywhere, please accept this flag in memory of the honorable and faithful service performed by (relationship)."**

25007. UNIT OUTDOOR MEMORIAL SERVICES WHEN REMAINS ARE INTERNED AT DECEASED HOME OF RECORD

1. There may be times when conducting a memorial service in a chapel is not possible or desirable. Such as in a combat situation, where no chapel is available, or when the commander desires to have an all hands, out-of-doors, memorial service. An out-of-door memorial service normally consists of: final roll call; boots and rifle ceremony; eulogy; and firing detail. This type of memorial service is for those Marines killed in the line of duty (e.g., killed in action (KIA), while a sentry on post, training accident.)

2. Normally this type of memorial service is conducted at company, or units of a similar size, level. The formation is company line, platoon line. (See figure 25-9.)

3. The personnel support required, in addition to the company, is:

a. A "boots and rifle" detail consisting of three Marines for each KIA (one carries a rifle with fixed bayonet, one carries a helmet, one carries a pair of boots and set of identification tags) are positioned 6 paces in front of and centered on the company commander. (See figure 25-9.) The rifle bearer is in the center, the helmet bearer is on the right and the boots/dog tag bearer is on the left.

Enclosure (1)

b. Firing detail positioned on the left front of the company, but facing so as not to fire over the formation. (See figure 25-9.)

c. Bugler. Positioned on the right front of the company. (See figure 25-9.)

d. Chaplain. (If available) Positioned near the company commander.

4. The recommended sequence of events is as follows:

a. H-15 Minutes. Company is formed as described in chapter 10, The "boots and rifle" detail(s), firing detail, bugler and chaplain are in position and at parade rest. (See figure 25-9.)

b. H-Hour. The company commander calls the company to attention, then faces about so as the company is to his/her rear. The chaplain then announces "**LET US PRAY,**" and leads the company in prayer. (If no chaplain is available the company executive officer or company gunnery sergeant reads the "Marine's Prayer.") After the prayer is finished the company commander faces the company and commands "**FIRST SERGEANT.**"

c. The first sergeant moves to a position 3 paces in front of the company commander and halts. The company commander then directs the first sergeant to "**READ THE FINAL ROLL CALL.**" The first sergeant faces the company and reads the roll of the Marines being honored (e.g., "**LANCE CORPORAL JOSEPH S. BANOTZ, 2D SQUAD, 3RD PLATOON, INDIA COMPANY, 7TH MARINE REGIMENT. KILLED IN ACTION 25 MARCH 1968 WHILE IN ACTION AGAINST AN ENEMY FORCE IN QUANG NAM PROVINCE, REPUBLIC OF VIETNAM**"). (Similar information is read for each KIA.)

d. As each Marine's name is read, the three Marines representing him execute the following movements:

(1) The rifle bearer takes one step forward, halts, rotates the rifle counter clockwise until the bayonet is facing down and the magazine well is towards the company, sticks the bayonet into the ground, then steps back.

(2) The helmet bearer then steps forward, places the helmet on the butt of the rifle and steps back.

(3) The boots/dog tag bearer then steps forward, hangs the dog tags from the pistol grip, places the boots in front of the rifle (toes towards company) and steps back. This process is repeated as each KIA's name is read.

e. After the last KIA's name is read, the first sergeant returns to his/her post behind the company. The company commander then commands "**Parade, REST.**" The company commander then talks about each Marine, where they were from, how long they were with the company, etc. After each Marine has had a "eulogy" the company commander then commands "**Company, ATTENTION**" and "**Present, ARMS.**" The company and "boots and rifle" detail(s) execute. The company commander then faces about and commands "**HONOR THE DEAD.**" The company commander and guide then present arms.

f. The noncommissioned officer in charge of the firing detail has the detail fire three volleys, and go to present arms as described in chapter 26. The bugler then plays "Taps." After the last note of "Taps" the company commander and guide go to the order. The company commander then faces about and commands "**Order, ARMS.**" All hands go to order arms.

g. The company commander or first sergeant, as described in chapter 10 then dismisses the company.

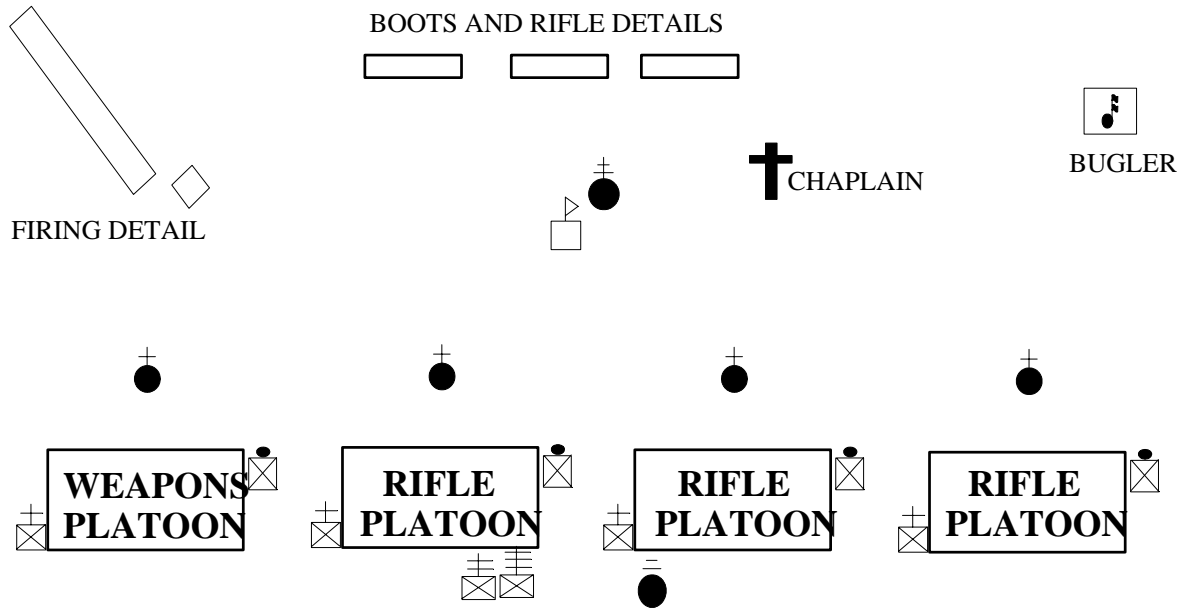

Figure 25-9.--Company Memorial Formation.

25008. UNIT INDOOR MEMORIAL SERVICES WHEN REMAINS ARE INTERNED AT DECEASED HOME OF RECORD

1. When conducting memorial services in a chapel the key thing to remember is that the chaplain has the final authority. Close coordination with the chaplain and the family (if present) is required. Although each religion has variations in their services, the basic memorial service would follow a sequence of events something like the following:

- a. Prelude. Musical selections.
- b. Welcome. Usually by the chaplain or commander.
- c. Posting of the colors and "*National Anthem*." (See paragraph 7307.) The color guard is uncovered and unarmed and the riflemen may be omitted.
- d. Invocation (posting of colors and invocation may be reversed).
- e. Bible readings, hymns, eulogies, etc. (Navy Hymn, Marine's Prayer, etc.).
- f. Call the Roll; after the eulogy, the unit commander will stand and command **"CALL THE ROLL."** The first sergeant (or platoon sergeant, etc.) will stand and begin calling the roll of members of the deceased's unit who are in attendance. They will answer **"Present."** This will be done three times. The fourth name to

be called will be the deceased. The first sergeant will repeat the name three times, each time increasing the volume. After the third time the bugler will play "Taps."

Note: If the deceased's family desires not to have "Call the Roll" then this will be omitted and only "Taps" played.

g. "Taps."

h. Benediction and retiring of the colors (may be in any order).

2. If a firing detail is used during an indoor memorial service, the detail fires three volleys just before "Taps." The detail is outside the chapel, and fires in a direction away from the chapel.

MARINE CORPS DRILL AND CEREMONIES MANUAL

PART II: CEREMONIES

CHAPTER 26

LOADING AND CEREMONIAL FIRING OF THE M16 RIFLE

	<u>PARAGRAPH</u>	<u>PAGE</u>
GENERAL	26000	26-3
TO LOAD	26001	26-3
TO FIRE BY VOLLEY	26002	26-6
TO UNLOAD	26003	26-7

FIGURE

26-1	FIRING PARTY FORMED FOR CEREMONIAL FIRING	26-3
26-2	RIFLEMEN FACE HALF RIGHT	26-4
26-3	RIFLEMEN MOVES THE LEFT FOOT 12 INCHES TO THE LEFT.	26-4
26-4	RIFLE TO PORT ARMS	26-5
26-5	CHAMBERING A ROUND	26-5
26-6	FIRING PARTY IN POSITION OF AIM AND FIRE	26-6

MARINE CORPS DRILL AND CEREMONIES MANUAL

PART II: CEREMONIES

CHAPTER 26

LOADING AND CEREMONIAL FIRING OF THE M16 RIFLE

26000. GENERAL

1. For ceremonial firing of the rifle, only the front rank of units larger than a squad executes the loading and firing of the rifle.
2. Normally a firing detail will consist on one noncommissioned officer and seven riflemen. When inadequate manpower is available to provide a full firing detail then one noncommissioned officer and at least three riflemen should be provided. The firing detail should be composed of an odd number of riflemen to honor ancient naval superstitions and traditions.
3. Except during actual firing, loaded rifles are kept on SAFE without command until **"UNLOAD"** or **"Inspection, ARMS"** is ordered.
4. In order to enhance the appearance of the firing party, magazines with three rounds will be inserted into the rifle out of view of spectators. Two expended cartridges should be placed in the magazine below the three blank cartridges so that adequate tension will be placed on the magazine spring. A round will not be placed in the chamber until the command **"LOAD"** is given.

26001. TO LOAD

1. The firing party is formed in line, with the noncommissioned officer in charge 3 paces in front of and 1 pace to the right of the firing party.
2. With the firing party formed and at attention (see figure 26-1), the command is **"With Blank Ammunition, LOAD."** The movements are executed quickly and smartly.



Figure 26-1.--Firing Party Formed for Ceremonial Firing.

3. On the command **"LOAD,"** members of the firing party execute the following sequence of movements:

- a. Face half right. (See figure 26-2.)



Figure 26-2.--Riflemen Face Half Right.

- b. Move the left foot 12 inches to the left. (See figure 26-3.) The legs are kept straight so the weight of the body rests equally on both feet.



Figure 26-3.--Riflemen Moves the Left Foot 12 Inches to the Left.

- c. Raise the rifle to port arms. (See figure 26-4.)



Figure 26-4.--Rifle to Port Arms.

- d. Pull the charging handle fully to the rear with the right hand and release it, thus chambering a round of blank ammunition. (See figure 26-5.)



Figure 26-5.--Chambering a Round.

- e. Move the right hand to the piston grip.

26002. TO FIRE BY VOLLEY

1. After the rifles are loaded as described in paragraph 26001, the noncommissioned officer in charge of the firing party orders, **"Ready, Aim, FIRE."**
2. On **"Ready,"** each rifleman moves the selector lever from SAFE to SEMI-AUTOMATIC with the right thumb.
3. On **"Aim,"** each rifleman raises the rifle to a position of 45 degrees from the horizontal, places the butt of the rifle firmly in the right shoulder, and rests the handguard in the "V" formed by the thumb and forefinger of the left hand. The fingers are extended and joined. The left wrist is straight. The right hand is wrapped around the pistol grip from the right. The right elbow is raised to near shoulder height. The head is turned 90 degrees to the left and held erect. Both eyes remain open with the right eye looking out over the front sight. (See figure 26-6.)



Figure 26-6.--Firing Party in Position of Aim and Fire.

4. On **"FIRE,"** squeeze the trigger quickly and lower the rifle to the position of port arms.
5. To continue firing with weapons equipped with blank firing adapters, the commands are **"Aim, FIRE."** Each command is executed as explained above.
6. To continue firing with weapons not equipped with blank firing adapters, the commands are **"Ready, Aim, FIRE."**
 - a. On **"Ready,"** each rifleman manually chambers the next round.
 - b. **"Aim"** and **"FIRE"** are executed as describe above.

7. After the last round has been fired, rifles are brought to the position of port arms. From this position the noncommissioned officer in charge of the firing party gives the command of "**Present, ARMS.**" This movement is executed in three steps on the command of execution "**ARMS.**"

a. With the left foot extended, pivot on the heel of the left foot and toe of the right foot, as in the first count of a left face.

b. Bring the heel of the right foot smartly against the heel of the left foot, completing the left face.

c. The riflemen then moves the rifle to present arms. The noncommissioned officer in charge of the firing party then executes a right face and present sword.

8. After the ceremony, (memorial service, funeral, etc.) the firing party is brought to order arms, faced to the right and marched from the site of the ceremony.

26003. TO UNLOAD

1. The weapons will be unloaded and inspected as soon as possible after leaving he site of the ceremony and out of sight of the spectators, if possible.

2. The command is "**UNLOAD.**" It is executed by executing inspection arms with magazine as describe in paragraphs 3113.1 and 3113.2.

MARINE CORPS DRILL AND CEREMONIES MANUAL

APPENDIX A

MANUAL OF ARMS WITH THE M1 SERVICE RIFLE

	<u>PARAGRAPH</u>	<u>PAGE</u>
GENERAL	A-1	A-3
ORDER ARMS	A-2	A-4
TRAIL ARMS FROM ORDER ARMS	A-3	A-5
FIX BAYONETS	A-4	A-6
SLING ARMS	A-5	A-7
PORT ARMS FROM ORDER ARMS	A-6	A-7
PRESENT ARMS FROM ORDER ARMS	A-7	A-8
ORDER ARMS FROM PRESENT OR PORT ARMS	A-8	A-9
INSPECTION ARMS FROM ORDER ARMS	A-9	A-10
PORT ARMS FROM INSPECTION ARMS	A-10	A-12
RIGHT SHOULDER ARMS FROM ORDER ARMS	A-11	A-13
PORT ARMS FROM RIGHT SHOULDER ARMS	A-12	A-14
ORDER ARMS FROM RIGHT SHOULDER ARMS	A-13	A-15
RIGHT SHOULDER ARMS FROM PORT ARMS	A-14	A-16
LEFT SHOULDER ARMS FROM ORDER ARMS	A-15	A-18
PORT ARMS FROM LEFT SHOULDER ARMS	A-16	A-18
ORDER ARMS FROM LEFT SHOULDER ARMS	A-17	A-19
LEFT SHOULDER ARMS FROM PORT ARMS	A-18	A-19
RESTS WITH THE RIFLE	A-19	A-19
ATTENTION FROM REST POSITIONS	A-20	A-20
RIFLE SALUTES	A-21	A-21
TO STACK ARMS	A-22	A-22
TO TAKE ARMS	A-23	A-25
LOADING AND CEREMONIAL FIRING OF THE RIFLE	A-24	A-26

MARINE CORPS DRILL AND CEREMONIES MANUAL

FIGURE

	<u>PAGE</u>
A-1 M1 RIFLE NOMENCLATURE	A-3
A-2 LEFT HAND AT THE RIFLE BALANCE	A-4
A-3 POSITION OF ORDER ARMS	A-5
A-4 POSITION OF TRAIL ARMS	A-6
A-5 PORT ARMS FROM ORDER ARMS	A-8
A-6 PRESENT ARMS FROM ORDER ARMS	A-9
A-7 ORDER ARMS FROM PRESENT ARMS	A-10
A-8 ORDER ARMS FROM PORT ARMS	A-10
A-9 INSPECTION ARMS FROM ORDER ARMS	A-11
A-10 PORT ARMS FROM INSPECTION ARMS	A-12
A-11 RIGHT SHOULDER ARMS FROM ORDER ARMS	A-13
A-12 PORT ARMS FROM RIGHT SHOULDER ARMS	A-14
A-13 ORDER ARMS FROM RIGHT SHOULDER ARMS	A-15
A-14 RIGHT SHOULDER ARMS FROM PORT ARMS	A-17
A-15 PORT ARMS FROM LEFT SHOULDER ARMS	A-18
A-16 PARADE REST WITH THE RIFLE	A-20
A-17 RIFLE SALUTE AT RIGHT SHOULDER ARMS	A-21
A-18 RIFLE SALUTE AT ORDER OR TRAIL ARMS	A-22
A-18a STACK ARMS, PASSING THE LEFT RIFLE	A-23
A-18b STACK ARMS, PLACING THE LEFT RIFLE	A-24
A-18c STACK ARMS, PLACING THE RIGHT RIFLE	A-24
A-18d STACK ARMS, STACK COMPLETE	A-25
A-18e CLOSE UP OF STACKING SWIVELS	A-25
A-19 ENGAGING THE OPERATING ROD HANDLE	A-27
A-20 FIRING PARTY AT POSITION OF FIRE	A-28

APPENDIX A

MANUAL OF ARMS WITH THE M1 SERVICE RIFLE

A-1. GENERAL

1. This Appendix is designed to provide detailed instructions for the manual of arms for the M1 service rifle for those units and organizations that use this weapon for ceremonial purposes.
2. The balance is the center of your rifle. (See figure A-1.) In performing the manual of arms it is often necessary to hold the rifle in your left hand for balance. (See figure A-2.) In so doing, the rifle is held between the thumb and fingers. Include the sling in your grip. Keep your fingers straight and together. Your thumb and fingers form a "U."
3. When the rifle is held across your body (see figure A-2), the barrel will cross the point where your neck and left shoulder join. The butt will be in front of your right hip. The rifle is held in the palm of your left hand at the balance. Your wrist is straight.
4. The cadence for rifle movement is 112 to 120 counts per minute.
5. While marching at double time, the rifle will be held across your body.
6. The manual of arms or the rifle is taught while halted. However, to add interest to drill or lessen fatigue, right (left) shoulder arms and port arms may be commanded when marching at quick time. These commands are given as the right foot strikes the deck and execution is begun as the left foot next strikes the deck.

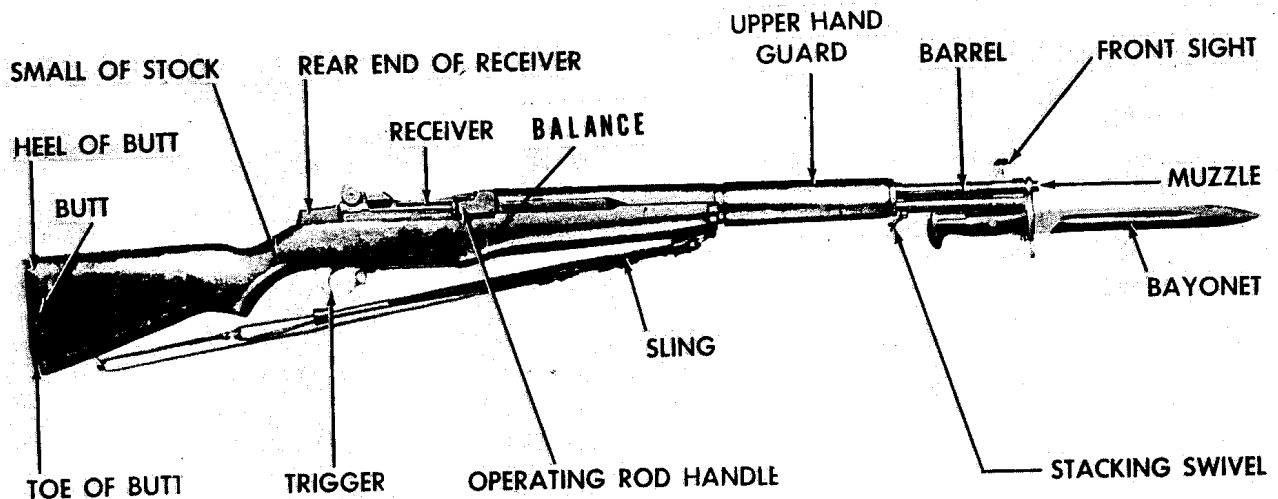

Figure A-1.--M1 Rifle Nomenclature.



Figure A-2.--Left Hand at the Rifle Balance.

A-2. ORDER ARMS

1. When halted, come to order arms when any of the following commands are given: **"Squad (Platoon or Company), ATTENTION; FALL IN; or Order, ARMS."**
2. At the command of execution, place the butt on the deck along the outer edge of the right shoe. The toe of the butt is on line with the toe of the shoe. The rifle's upper hand guard rests in a "V" formed by your thumb and forefinger. All fingers are straight and joined. Your right hand and arm are behind the rifle. This may cause a slight bend in your elbow. The tips of your thumb and forefinger are kept on line with the open edge of the upper hand guard. Your right thumb should also be along the trouser seam. Except for your right hand, the entire body is at attention. (See figure A-3.)



a. Front View



b. Side View.

Figure A-3.--Position of Order Arms.

A-3. TRAILS ARMS FROM ORDER ARMS

1. The command is "**Trail, ARMS.**" It may be given only from order arms. It is executed in one count. On "**ARMS,**" close the fingers and thumb of your right hand around the upper hand guard. This will raise the rifle butt 2 inches from the deck and point the muzzle slightly forward. Do not bend your elbow. In the proper position the rifle will form a 15-degree angle with your leg. (See figure A-4.) Remain at trail arms until order arms is given.

2. Trail arms is used for short distance movements. If a marching movement (a side step, back step, or forward march) is ordered while at order arms come to trail arms automatically on the command of execution for the marching movement. The same applies for facing movements, while at order arms. Whenever trail arms is automatically assumed, come to order arms, without command, upon completion of the marching or facing movement.

3. Order Arms from Trail Arms. The command is "**Order, ARMS.**" On "**ARMS,**" ease your rifle to the position of order by relaxing the grip of your right hand on the upper hand guard. Return your fingers to the position described in paragraph A-2.2.



Figure A-4.--Position of Trail Arms.

A-4. FIX BAYONETS

1. The command is "**Fix, BAYONETS.**" It is given only from order arms.
2. On "**BAYONETS,**" pass the muzzle across your body to the left front and grasp the rifle with your left hand just below the stacking swivel. Then grip the bayonet handle with your right hand. Push the bayonet handle down and forward and draw the bayonet from the scabbard. Fix the bayonet on the rifle without changing your grip on the handle. You may look down at the muzzle while doing so. Then come back to order arms.
3. These movements are not made in cadence, but should be carried out quickly and smartly.

4. Unfit Bayonets

a. The command is **"Unfix, BAYONETS."** It will be given only when at order arms.

b. On **"BAYONETS,"** move the rifle to your left hand as for fix bayonets. Grip the bayonet handle with your right hand and press the catch spring. You may look down while doing this. Raise the bayonet straight up until the handle is a foot above the muzzle. Keep watching the point of the bayonet. Rotate it so the point is down and the back of your hand is toward your body. Replace the bayonet in the scabbard. Then come back to order arms.

c. These movements are not made in cadence, but should be carried out quickly and smartly.

A-5. SLING ARMS

1. The command is **"Sling, ARMS."** It will be given only from order arms. The movements are not executed in cadence.

2. If the sling is not ready, on **"ARMS,"** place your left foot 6 inches to the rear and slightly left of your right heel. At the same time, lift the rifle until the butt is opposite your right hip. Take the rifle at the balance with your left hand, sling to the left. Let your body bend slightly forward. Place the butt in the crotch formed by your hip and right leg. Move the balance of the rifle to the inside of our right elbow and cradle it there so both hands will be free to loosen the sling. Then sling the rifle on your right shoulder in the easiest manner and, except for your right hand, come back to attention. At sling arms, your right hand grips the sling directly in front of your right armpit, the sights point rearward and the barrel straight up.

3. On **"ARMS,"** if the sling is ready, sling the rifle on your right shoulder in the easiest way.

4. This position is used for long parades and marches.

5. Unslung Arms from Sling Arms

a. The command is **"Unsling, ARMS."** It will be given only when at sling arms.

b. On **"ARMS,"** swing the rifle, by the sling, from your shoulder. Catch the rifle at the balance with your left hand. Release the sling and grasp the upper hand guard with your right hand. Lower the rifle to the order. These movements are not done in cadence, but should be executed smartly.

6. Adjust Slings from Order Arms. For the manual to be executed with snap, it is necessary for the rifle sling to be tight. The command is **"Adjust, SLINGS."** It will be given only when at order arms with loose slings. On the command of execution take up the same position used to loosen sling (see paragraph A-5.2 above) and tighten the sling. Then return to order arms. This is done without cadence.

A-6. PORT ARMS FROM ORDER ARMS

1. The command is **"Port, ARMS."** This movement is executed in two counts.

2. On **"ARMS,"** lift the rifle to the left front until your right hand is in front and slightly left of your face and your forearm is parallel to the deck. On the same count take the rifle by the balance with your left hand.
3. On the second count, move your right hand from the upper hand guard to the small of the stock. Grip it palm down. Upon completing the movement, both elbows will be against your sides and your right forearm parallel with the deck. Your left thumb is 4 inches in front of the center of your chest. (See figure A-5.)



a. Count One.



b. Count Two.

Figure A-5.--Port Arms from Order Arms.

A-7. PRESENT ARMS FROM ORDER ARMS

1. The command is **"Present, ARMS."** This movement is executed in two counts and is used as a salute in ceremonies and interior guard duty. When executed from any position of the manual other than order arms the rifle is first brought to port arms upon the command **"Present, ARMS."** Present arms is then executed without loss of cadence.
2. On **"ARMS,"** raise the rifle to a position 4 inches in front of the center of your body, barrel toward you and pointing straight up. At the same time grasp the balance of the piece with your left hand, thumb on the rear hand guard band, fingers joined, sling included in your grip, and elbows against your body. The stacking swivel is at the same level as your eyes.
3. Do the second count, move your right hand to the small of the stock and grasp it. Both elbows are at your sides. (See figure A-6.)



a. Count One.



b. Count Two.

Figure A-6.--Present Arms from Order Arms.

A-8. ORDER ARMS FROM PRESENT AND PORT ARMS

1. The command is "**Order, ARMS.**" It is a three-count movement from either position and will be executed the same way from each.
2. On "**ARMS,**" move your right hand smartly from the small of the stock to the upper hand guard.
3. On the second count, release the balance with your left hand and lower the rifle to a point where the butt is 3 inches from the deck, slightly to the right of your right toe, and the muzzle pointing straight up. While lowering the rifle move your left hand, thumb and fingers are straight and joined, to a point near the stacking swivel. This is merely to steady the piece. Keep your palm facing to the rear so it will not resemble a rifle salute. The forearm and wrist are straight.
4. On the third count, lower the butt gently to the deck and your left hand smartly back to your left side. After this you are at the position of order arms. (See figures A-7 and A-8.)



a. Count One.



b. Count Two.



c. Count Three.

Figure A-7.--Order Arms from Present Arms.



a. Count One.



b. Count Two.



c. Count Three.

Figure A-8.--Order Arms from Port Arms.

A-9. INSPECTION ARMS FROM ORDER ARMS

1. The command is "**Inspection, ARMS.**" It is a five-count movement. When executed from any position of the manual other than order arms the rifle is first brought to port arms upon the command of "**Inspection, ARMS.**" Inspection arms is then executed without loss of cadence. (See figure A-9.)

2. On "**ARMS,**" lift the rifle to the left front until your right hand is in front and slightly left of your face and your forearm is parallel with the deck. At the same time, grasp the piece at the balance with your left hand as for port arms.

3. On the second count, move your right hand from the upper hand guard to the small of the stock. Grip it palm down.

MARINE CORPS DRILL AND CEREMONIES MANUAL

4. On the third count, release the balance with your left hand. Double your fingers into a fist. Place your thumb on the operating rod handle and push smartly to the rear until engaged by the operating rod catch. In doing this don't raise your elbow from your side.

5. On the fourth count move your left hand back to the balance. At the same time look into the receiver by bending your head forward smartly. If the receiver is not empty, empty it.

6. On the fifth count, raise your head back to attention.



a. Count One.



b. Count Two.



c. Count Three.



d. Count Three--Continued.

Figure A-9.--Inspection Arms from Order Arms.



e. Count Four.



f. Count Five.

Figure A-9.--Inspection Arms from Order Arms--Continued.

A-10. PORT ARMS FROM INSPECTION ARMS

1. The command is **"Port, ARMS."** It is a one count movement and the only command that may be given from inspection arms.
2. On **"Port,"** place the heel edge of your right hand on the operating rod handle and push to the rear. Your fingers should be straight and joined. At the same time, push the follower down with your thumb. Allow the bolt to slide forward about a quarter-inch.
3. On **"ARMS,"** allow the bolt to go home by lifting your hand smartly. Pull the trigger and replace your right hand on the small of the stock. (See figure A-10.)



a. Movement on Port.



b. Movement on Arms.

Figure A-10.--Port Arms from Inspection Arms.

A-11. RIGHT SHOULDER ARMS FROM ORDER ARMS

1. The command is **"Right Shoulder, ARMS."** It is a four-count movement.
2. On **"ARMS,"** lift the rifle across your body. At the same time, take the balance in your left hand.
3. On the second count, release the upper hand guard with your right hand. Take the heel of the butt between the first two fingers of your right hand and close your fingers and thumb around the stock. Your thumb and index fingers touch.
4. On the third count, place the rifle in your right shoulder without changing your grip on the butt. The sights are up; the piece is tilted at an angle of 45 degrees to the deck, and held so it points directly fore and aft. Your right elbow is against your side and your right forearm level with the deck. While placing the rifle on your shoulder, allow your left hand to slide to the small of the stock. Your left hand guides the rifle to your shoulder. The first joint of the your left forefinger touches the rear of the receiver. Your left wrist is straight and left forearm level with the deck. Keep your palm facing to the rear, so it will not resemble a rifle salute.
5. On the fourth count, move your left hand smartly back to your side. (See figure A-11.)



a. Count One.



b. Count Two.

Figure A-11.--Right Shoulder Arms from Order Arms.



c. Count Three



d. Count Four.

Figure A-11.--Right Shoulder Arms from Order Arms--Continued.

A-12. PORT ARMS FROM RIGHT SHOULDER ARMS

1. The command is "**Port, ARMS.**" It is a two-count movement.
2. On "**ARMS,**" jerk the butt down so the rifle will spring from your shoulder. As it leaves your shoulder, twist the butt clockwise one quarter-turn so the rifle will fall in front of your chest, barrel up. Keep your grip on the butt. Raise your left hand smartly to catch the balance 4 inches in front of the center of your chest.
3. On the second count, move your right hand to the small of the stock. (See figure A-12.)



a. Start.



b. Count One.



c. Count Two.

Figure A-12.--Port Arms from Right Shoulder Arms.

A-13. ORDER ARMS FROM RIGHT SHOULDER ARMS

1. The command is **"Order, ARMS."** It is executed in four counts.
2. At **"ARMS,"** remove the rifle from your shoulder in the same manner as described for port arms from right shoulder arms. (See paragraph A-12.2.)
3. On the second count, remove your right hand from the butt and smartly grasp the upper hand guard. Keep your elbow up and your forearm level.
4. On the third count, release the balance with your left hand and lower the rifle to a point where the butt is 3 inches from the deck, slightly to the right of your right toe, and the muzzle pointing straight up. While lowering the rifle move your left hand, thumb and fingers straight and joined to a point near the stacking swivel. This is merely to steady the piece. Keep your palm facing the rear, so it will not resemble a rifle salute. The forearm and wrist are straight.
5. On the fourth count, lower the butt gently to the deck and move your left hand smartly back to your left side. After this you are at the position of order arms. (See figure A-13.)



a. Count One.



b. Count Two.

Figure A-13.--Order Arms from Right Shoulder Arms.



c. Count Three.



d. Count Four.

Figure A-13.--Order Arms from Right Shoulder Arms--Continued.

A-14. RIGHT SHOULDER ARMS FROM PORT ARMS

1. The command is **"Right Shoulder, ARMS."** It is executed in three counts.
2. On **"ARMS,"** release the small of the stock and grip the heel of the butt between the first two fingers of your right hand. Close your thumb and fingers around the stock. Your thumb and index finger touch.
3. On the second count, place the rifle on your right shoulder without changing your grip on the butt. The sights are up; the piece is tilted at an angle of 45 degrees to the deck, and held so it points directly fore and aft. Your right elbow is against your side and your right forearm level with the deck. While placing the rifle on your shoulder, allow your left hand to slide to the small of the stock. Your left hand guides the rifle to your shoulder. The first joint of the your left forefinger touches the rear of the receiver. Your left wrist is straight and left forearm level with the deck. Keep your palm facing to the rear, so it will not resemble a rifle salute.
3. On the third count, move your left hand smartly back to your side. (See figure A-14.)



a. Start.



b. Count One.



c. Count Two.



d. Count Three.

Figure A-14.--Right Shoulder Arms from Port Arms.

A-15. LEFT SHOULDER ARMS FROM ORDER ARMS

1. The command is "**Left Shoulder, ARMS.**" It is a four-count movement.
2. On "**ARMS,**" carry the rifle across your body with your right hand. At the same time, take the balance in your left hand.
3. On the second count, release the upper hand guard and grip the small of the stock with your right hand.
4. On the third count, release the balance with your left hand and place the rifle on your left shoulder with your right hand. At the same time take the heel of the butt between the first two fingers of your left hand. Close your left hand. Close your left thumb and fingers around the stock. Your thumb and index finger touch. The piece is at a 45-degree angle to the deck, and the sights up. Keep the rifle pointing directly fore and aft. Your left elbow is against your side, your left forearm level with the deck.
5. On the fourth count, move your right hand smartly back to your side.

A-16. PORT ARMS FROM LEFT SHOULDER ARMS

1. The command is "**Port, ARMS.**" It is executed in two counts.
2. On "**ARMS,**" grip the small of the stock with your right hand.
3. On the second count, release the butt with your left hand. At the same time, move the rifle across your body with your right hand and grip the balance with your left. The rifle's and your position are the same as described in paragraph A-12.2. (See figure A-15.)



a. Start.



b. Count One.



c. Count Two.

Figure A-15.--Port Arms from Left Shoulder Arms.

A-17. ORDER ARMS FROM LEFT SHOULDER ARMS

1. The command is "**Order, ARMS.**" This is a five-count movement.
2. On "**ARMS,**" grip the small of the stock with your right hand.
3. On the second count, release the butt with your left hand. At the same time, move the rifle across your body with your right hand and grip the balance with your left. The rifle is now at the position of port arms.
4. On the third count, move your right hand to the upper hand guard, with your forearm level with the deck.
5. On the fourth count, release the balance with your left hand. Lower the rifle to a position in which the butt is 3 inches from the deck, slightly to the right of your right toe, and the muzzle straight up. While lowering the rifle move your left hand, thumb and fingers straight and joined, to a point near the stacking swivel. This is merely to steady the piece. Keep your palm facing the rear and your forearm and wrist straight.
6. On the fifth count, ease the rifle to the deck and move your left hand smartly to your side.

A-18. LEFT SHOULDER ARMS FROM PORT ARMS

1. The command is "**Left Shoulder, ARMS.**" It is executed in two counts.
2. On "**ARMS,**" release the balance with your left hand. Place the rifle on your left shoulder with your right hand. The barrel should point upward, tilted at an angle of 45 degrees to the deck. At the same time, take the heel of the butt between the first two fingers of your left hand. Wrap your thumb and fingers around the stock. Your index finger and thumb touch. Keep your left elbow against your side. Keep your left forearm level with the deck.
3. On the second count move your right hand smartly back to your right side.

A-19. RESTS WITH THE RIFLE

1. Parade Rest from Order Arms. The command is "**Parade, REST.**" It is executed in one count. It may be given only from order arms. On "**REST,**" move your left foot smartly 12 inches to the left. Keep your legs straight so your weight rests equally on both feet. Keep the butt of the rifle on the deck, toe online with the front of your right shoe. Slide your right hand upward, re-grasping the upper hand guard just below the stacking swivel. Fingers joined and curled around touching the thumb. Straighten your right arm directly to the front so that the muzzle points forward and up. Place your left hand behind you, just below your belt. Your fingers should be straight and joined your palm flat and facing rear. (See figure A-16.) Parade rest will also be assumed on the preparatory command to "**ATTENTION,**" if not already at parade rest. Parade rest is assumed as described herein except if at sling arms, the rifle remains slung; if at unsling arms, sling arms first; if at stack arms, assume parade rest without taking arms.
2. At Ease. The command is "**AT EASE.**" It is a one-count movement. It may be given only when halted at attention at order arms, sling arms or unsling arms,

or stack arms. After the command "**AT EASE,**" you may move your left leg, but must keep your right in place. The rifle is held as in parade rest, but with a relaxed arm, when executed from order arms or unsling arms. You may move, but must not talk.

3. Rest. The command is "**REST.**" It may be given only when halted at attention at order arms, sling or unsling arms, or stack arms, and is executed in one count. At the command "**REST,**" keep your right foot in place. Your rifle is held as in parade rest, but with a relaxed arm when executed from order arms or unsling arms. If at sling arms, the rifle may be unslung. You may move and talk.

4. Fall Out from Attention. The command is "**FALL OUT.**" It may be given only when halted at attention with your rifle at order, port, stack, or unsling arms. On the command "**FALL OUT,**" leave you place in ranks, but remain in the immediate vicinity unless otherwise instructed.



a. Front View.



b. Side View.

Figure A-16.--Parade Rest with the Rifle.

A-20. ATTENTION FROM REST POSITIONS

1. The command is "**Squad (Platoon, or Company), ATTENTION.**"

a. On "**Squad (Platoon or Company),**" come to parade rest as described in paragraph A-19.1.

b. On "**ATTENTION,**" come to order arms in one count, except if at sling arms, come to attention at sling arms; if at stack arms, come to attention.

c. From Fall Out. The command is "**FALL IN.**" On the command "**FALL IN,**" go back to your place in ranks and come to attention at order arms or unsling arms. If your rifle is stacked, come to attention.

A-21. RIFLE SALUTES

1. Rifle Salute at Right Shoulder Arms. This is a one-count movement, executed on each of two sets of commands "**Rifle, SALUTE**" and "**Ready, TWO.**" It cannot be executed at left shoulder arms.

a. On "**SALUTE,**" move your left hand smartly to the small of the stock. Keep your left forearm level with the deck, palm down, your thumb and fingers straight and joined. The first joint of your forefinger touches the rear of the receiver. (See figure A-17.) When not in ranks, turn your head and eyes toward the person or colors saluted.

b. On "**TWO,**" move your left hand smartly back to your side.



Figure A-17.--Rifle Salute at Right Shoulder Arms.

2. Rifle Salute at Order or Trail Arms. These are one-count movements executed on each of two sets of commands "**Rifle, SALUTE**" and "**Ready, TWO.**"

a. On "**SALUTE,**" move your left hand smartly to your right side, palm down, thumb and fingers straight and joined. The first joint of your forefinger touches the barrel between the stacking swivel and the bayonet lug. (See figure A-18.) When not in ranks, turn your head and eyes toward the person or colors saluted.

b. On "**TWO,**" move your left hand smartly back to your side.



a. Rifle Salute at Order Arms.



b. Rifle Salute at Trail Arms.

Figure A-18.--Rifle Salute at Order or Trail Arms.

3. Hand Salute at Sling Arms. This is executed in the same manner as a hand salute without arms, except your left hand must hold the rifle sling to steady it. As you salute, move your left hand smartly toward your right shoulder. Grip the sling in front of your right shoulder. When the salute is finished, re-grasp the sling with your right hand. If the rifle is slung on the left shoulder, the hand salute is rendered in the normal manner.

A-22 TO STACK ARMS

1. Members of the squad stack arms from their positions in line at normal or close interval. Squad members numbered 3, 7, and 11 make the stacks except when there is no one to their left. In squads larger than 14 men, additional stackmen are designated. In squads so armed that it is not feasible for numbers 3, 7, and 11 to make the stacks, other squad members may be designated as stackmen. The command is **"Stack, ARMS."**

2. At the command **"ARMS,"** the man on the left of the stackman grips his/her rifle by the upper hand guard, raises it, with the muzzle straight up, until his/her right arm is level with the deck. The Marine passes it to the stackman, who grips it with the left hand at the upper hand guard just below the stacking swivel. (See figure A-18a.)

3. The stackman places the butt of the left rifle between his/her feet, with the barrel to the front, muzzle tilted forward. The Marine raises the stacking swivel of the left rifle with his/her left thumb and forefinger. Then the Marine swings the butt of his/her own rifle 2 feet in front and 6 inches to the right of his/her right toe. The Marine then shifts his/her right hand to the stacking swivel, which the Marine engages with that of the left rifle. (See figure A-18b.)

4. The member on the right of the stackman grips his rifle with his/her right hand at the small of the stock, his/her left hand near the stacking swivel. Without moving his right foot, the Marine steps to the left front and carries his/her rifle well forward, barrel up. With the forefinger of his/her left hand, the Marine hooks his stacking swivel to the free hook of the center rifle's stacking swivel. Then the Marine rotates his/her rifle so the barrel rests in the angle formed by the other two rifles. (See figure A-18c.) The Marine pulls the butt toward him/her until the stack is tight and then lowers the butt to the deck. The Marine then resumes the position of attention. (See figure A-18d.) Figure A-18e shows details of the stacking swivels at stack arms.

5. Other rifles are passed to the nearest stack on the right. When passing extra weapons to the stack, the right hand grips the upper hand guard and the left hand grips the balance. The muzzles of these weapons point straight up while they are being passed to the stack. They are laid on the stack by the stackman, sights inboard, and tilted so they remain in place.



Figure A-18a.--Stack Arms, Passing the Left Rifle.



Figure A-18b.--Stack Arms, Placing the Left Rifle.



Figure A-18c.--Stack Arms, Placing the Right Rifle.



Figure A-18d.--Stack Arms, Stack Complete.



Figure A-18e.--Close Up of Stacking Swivels.

A-23. TO TAKE ARMS

1. The squad, in line behind the stacks, takes arms at the command "**Take, ARMS.**"
2. At the command "**ARMS,**" the extra weapons are passed back. Weapons are held as when passed to the stack. As members receive their weapon, they resume order arms.

3. When extra weapons have been passed, the stackman grips his/her rifle and the rifle of the stackman on his/her left. The member on the right of the stackman steps to the left front as in stacking, takes his/her rifle, and resumes order arms.

4. The stackman then disengages the two remaining rifles. The Marine passes the left rifle back to the member on his/her left. The member on the stackman's left grips his/her rifle at the upper hand guard and resumes order arms. Then the stackman resumes order arms.

A-24. LOADING AND CEREMONIAL FIRING OF THE RIFLE

1. General Rules

a. For ceremonial firing, only the front rank of units larger than a squad executes the loading and firing.

b. Rifles are loaded while locked.

c. Except during the actual firing, loaded rifles are kept locked without command until "**UNLOAD**" or "**Inspection, ARMS**" is ordered.

2. To Load

a. The unit being at attention in any formation the command is "**With Blank Cartridges, LOAD.**" The movements are executed quickly and smartly, but not in cadence.

b. Each front rank rifleman faces half right and places his/her right foot 12 inches to the rear. The legs are kept straight, so the weight of the body rests equally on both feet.

c. The rifle is raised with the right hand and grasped at the balance with the left. The right hand is then moved to the small of the stock. The rifle is now at the position of port arms.

d. The operating rod handle is pulled smartly to the rear with the left thumb. (See figures A-19.)

e. A fully loaded (blank) clip is then removed from the cartridge belt and placed in the receiver with the right hand. The rear edge of the right hand is placed against the operating rod handle and the cartridge pressed down against the follower with the right thumb until the follower engages the clip latch. The operating rod handle is released and the thumb lifted to allow the bolt to slide forward. The rear of the operating rod handle is then pushed forward with the heel of the right hand to ensure the proper seating of the bolt.

f. The right hand is then returned to the small of the stock at port arms.

g. For instruction in loading, the command is "**Simulate, LOAD.**" The movements are executed as described in paragraph A-24.2, except that the handling of cartridges is simulated.

h. To use the rifle as a single loader, the procedure is the same except one cartridge is placed in the chamber rather than a clip in the receiver. Instead of depressing the clip against the follower, the follower is directly depressed with the right thumb.



Figure A-19.--Engaging the Operating Rod Handle.

3. To Unload. The command is "**UNLOAD,**" hook the left thumb over the operating rod handle and push it to the rear. Hold the bolt open. Re-grasping the rifle with the left hand, steady the piece by placing the butt on the right hip. Place the right hand over the receiver and release the clip latch with the right thumb. Catch the ejected clip in the right hand and replace it in the belt. After ensuring there is not a round in the chamber, allow the bolt to close. Pull the trigger and bring the piece to the order.

4. To Fire by Volley

a. After the rifles are loaded as prescribed in paragraph A-24.2, the noncommissioned officer in charge of the firing detail orders, "**Ready, Aim, FIRE.**"

b. On "**Ready,**" take the position of load if not already in that position.

c. On "**AIM,**" raise the rifle to a position of 45 degrees from the horizontal, the butt firmly in the right shoulder, the balance resting in the V formed by the thumb and forefinger of the left hand. All fingers of the left hand are extended and joined. The left wrist is straight. The right hand is wrapped around the small of the stock from the right. The right elbow is raised to shoulder height. The right cheek is pressed firmly against the stock (or thumb on top of the stock) as far forward as comfortable. The left eye is closed, the right looking over the rear sight. Press the safety to its unlock position with the right forefinger. (See figure A-20.)

MARINE CORPS DRILL AND CEREMONIES MANUAL

d. On **"FIRE,"** squeeze the trigger quickly and lower the rifle to the position of **"LOAD."** If the rifle has been loaded with a single round, it is reloaded without command, unless directed otherwise.

e. To continue the firing, the commands are **"Ready, Aim, FIRE."** Each command is executed as explained above.

f. To cease firing, the command is **"CEASE FIRING."** On this command the riflemen will know that no more rounds are to be fired. They bring their rifles to the position of load. The command **"UNLOAD"** is then given and executed as explained in paragraph A-24.3.



Figure A-20.--Firing Party at Position of Fire.