

SUBMIT TO: The School District of Osceola County, Florida Purchasing Department, Building 2000 817 Bill Beck Blvd. Kissimmee, FL 34744		<h1 style="text-align: center;">INVITATION TO BID</h1> <p style="text-align: center;">AN EQUAL OPPORTUNITY EMPLOYER www.osceola.k12.fl.us/depts/Purchasing/Index.asp</p> <p style="text-align: right;">Date issued: August 6, 2008</p>
CONTACT PERSON: Cheryl M. Jessee		
Telephone #: 407.870.4630 Fax #: 407.870.4616		

TITLE: <h2 style="text-align: center;">Fencing, Materials and Installation</h2>	NUMBER: SDCO 09-B-007 CJ	SUBMITTAL DEADLINE: <h2 style="text-align: center;">September 3, 2008</h2>
---	---	--

PRE BID DATE, TIME AND LOCATION: <h3 style="text-align: center;">August 20, 2008 at 9:00 AM in the Purchasing Conference Room</h3>	<i>SUBMITTALS RECEIVED AFTER ABOVE DATE AND TIME WILL NOT BE CONSIDERED</i>
--	---

FIRM'S NAME:	
MAILING ADDRESS:	
CITY - STATE - ZIP:	X _____ Authorized Signature
TELEPHONE NO:	_____ Typed Name
FAX NO:	_____ Title Date
FEDERAL ID NO. OR SOCIAL SECURITY NO.	_____ Email Address

THIS FORM MUST BE COMPLETED AND RETURNED WITH YOUR RESPONSE
GENERAL CONDITIONS AND INSTRUCTIONS
 ***** PLEASE READ CAREFULLY *****

Individuals covered by the Americans with Disabilities Act of 1990 in need of accommodations to attend public openings or meetings sponsored by the School District of Osceola County Purchasing Department shall contact the Purchasing Department at 407.870.4630, at least five (5) days prior to the scheduled opening or meeting.

- | | |
|---|---|
| <p>1. SUBMISSION OF OFFERS: All offers shall be submitted in a sealed envelope or package. The invitation number, title, and opening date shall be clearly displayed on the outside of the sealed envelope or package. The delivery of responses to the School District of Osceola County Purchasing Department prior to the specified date and time is solely and strictly the responsibility of the offeror. Any submittal received in the Purchasing Department after the specified date and time will not be considered.</p> <p>Responses shall be submitted on forms provided by the School Board. Additional information may be attached to the submittal. Facsimile submissions are NOT acceptable. No offer may be modified after acceptance. No offer may be withdrawn after opening for a period of sixty (60) days unless otherwise specified.</p> <p>2. EXECUTION OF OFFER: Offer shall contain a manual signature in the space(s) provided of a representative authorized to legally bind the offeror to the provisions therein. All spaces requesting information from the offeror shall be completed. Responses shall be typed or printed in ink. Use of erasable ink or pencil is not permitted. Any correction made by the offeror to any entry must be initialed.</p> <p>3. OPENING: Opening shall be public in the School District Purchasing Department immediately following the advertised deadline date and time for receipt of submittals. Pursuant to Section 119.07(3) (b) Florida Statutes (1991) no further information regarding offers submitted will be made public until such time of intended award or ten (10) days, whichever is earlier.</p> | <p>4. PUBLIC RECORD: The School District is governed by the Public Record Law, Chapter 119, Florida Statutes. Pursuant to Chapter 119 only trade secrets as defined in Section 812.081, Florida Statute shall be exempt from disclosure.</p> <p>5. CLARIFICATION/CORRECTION OF ENTRY: The School Board reserves the right to allow for the clarification of questionable entries and the correction of OBVIOUS MISTAKES.</p> <p>6. INTERPRETATION/ADDENDA: Any questions concerning conditions and specifications shall be directed to the designated contact person. Those interpretations which may affect the eventual outcome of the invitation/offer shall be furnished in writing to prospective offerors.</p> <p>No interpretation shall be considered binding unless provided in writing by the School District Purchasing Department in the form of an addendum. Any addenda issued shall be acknowledged by signature and returned with offeror's response.</p> <p>Failure to acknowledge addenda may result in the offer not being considered.</p> <p>7. INCURRED EXPENSES: This invitation does not commit the School Board to make an award nor shall the School Board be responsible for any cost or expense which may be incurred by any respondent in preparing and submitting a reply, or any cost or expense incurred by any respondent prior to the execution of a purchase order or contract agreement.</p> |
|---|---|

8. **PRICING:** Unless otherwise specified prices offered shall remain firm for a period of at least sixty (60) days; all pricing of goods shall include FOB DESTINATION, all packing, handling, shipping charges and delivery to any point(s) within the School District to a secure area or inside delivery; all prices of services shall include all expenses necessary to provide the service at the location specified.
9. **ADDITIONAL TERMS & CONDITIONS:** The School Board reserves the right to reject offers containing terms or conditions contradictory to those requested in the invitation specifications.
10. **TAXES:** The School District of Osceola County is exempt from Federal and State Tax for Tangible Personal Property, Florida State Exemption Certificate No. 85-8012500806C-9. Vendors or Contractors doing business with the School District of Osceola County shall not be exempted from paying sales tax to their suppliers for materials to fulfill contractual obligations with the District, nor shall any Vendor/Contractor be authorized to use the District's Tax Exemption Number in securing such materials.
11. **DISCOUNTS:** All discounts except those for prompt payment shall be considered in determining the lowest net cost for evaluation purposes.
12. **MEETS SPECIFICATIONS:** The offeror represents that all offers to this invitation shall meet or exceed the minimum requirements specified.
13. **BRAND NAME OR EQUAL:** If items requested by this invitation have been identified in the specifications by a Brand Name "OR EQUAL" description, such identification is intended to be descriptive and not restrictive and is to indicate the quality and characteristics of products that will be acceptable. Offers proposing "equal" products will be considered for award if such products are clearly identified in the offer and are determined by the School Board to meet fully the salient characteristic requirements listed in the specifications.

Unless the offeror clearly indicates in his/her offer that he/she is proposing an "equal" product, the offer shall be considered as offering the same brand name product referenced in the specifications.

If the offeror proposes to furnish an "equal" product, the brand name of the product to be furnished shall be clearly identified. The evaluation of offers and the determination as to equality of the product offered shall be the responsibility of the School Board and will be based on information furnished by the offeror. The Purchasing Department is not responsible for locating or securing any information which is not identified in the response and reasonably available to the Purchasing Department. To insure that sufficient information is available the offeror shall furnish as part of the response all descriptive material necessary for the Purchasing Department to determine whether the product offered meets the salient characteristics required by the specifications and establish exactly what the offeror proposes to furnish and what the School Board would be binding itself to purchase by making an award.

14. **SAMPLES:** When required, samples of products shall be furnished with response to the School Board at no charge. Samples may be tested and will not be returned to the offeror. The result of any and all testing shall be made available upon written request.
15. **SILENCE OF SPECIFICATIONS:** The apparent silence of these specifications or any supplemental specifications as to details or the omission from same of any detailed description concerning any point, shall be regarded as meaning that only the best commercial practices are to prevail and that only materials of first quality and correct type, size, and design are to be used. All workmanship shall be first quality. All interpretations of specifications shall be made upon the basis of this statement.
16. **GOVERNING LAWS AND VENUE:** All legal proceedings brought in connection with this Contract shall only be brought in a state or federal court located in the State of Florida. Venue in state court shall be in Osceola County, Florida. Venue in federal court shall be in the United States District Court, Middle District of Florida, Orlando Division. Each party hereby agrees to submit to the personal jurisdiction of these courts for

any lawsuits filed there against such party arising under or in connection with this Contract. In the event that a legal proceeding is brought for the enforcement of any term of the contract, or any right arising therefrom, the parties expressly waive their respective rights to have such action tried by jury trial and hereby consent to the use of non-jury trial for the adjudication of such suit.

All questions concerning the validity, operation, interpretation, construction and enforcement of any terms, covenants or conditions of this Contract shall in all respects be governed by and determined in accordance with the laws of the State of Florida without giving effect to the choice of law principles thereof and unless otherwise preempted by federal law.

17. **ASSIGNMENT:** Any agreement to purchase issued pursuant to this invitation and award thereof and the monies which may become due hereunder are not assignable except with the prior written approval of the School Board.
18. **CONTENT OF INVITATION/RESPONSE:** The contents of this invitation, all terms, conditions, specifications, and requirements included herein and the accepted and awarded response thereto may be incorporated into an agreement to purchase and become legally binding. Any terms, conditions, specifications, and/or requirements specific to the item or service requested herein shall supercede the requirements of the "GENERAL CONDITIONS AND INSTRUCTIONS."
19. **INDEMNIFICATION OF SCHOOL BOARD**
The bidder shall indemnify, hold harmless and defend the School Board, its officers, agents, and employees, from or on account of any claims, losses, expenses, injuries, damages, or liability resulting or arising solely from bidder's performance or nonperformance of services pursuant to this contract, excluding any claims, losses, expenses, injuries, damage, or liability resulting or arising from the actions of School Board, its officers, agents, or employees. The indemnification shall obligate the bidder to defend, at its own expense or to provide for such defense, at School Board's option, any and all claims and suits brought against School Board that may result from bidder's performance or nonperformance of services pursuant to the contract.
20. **PATENTS, COPYRIGHT, AND ROYALTIES:** The supplier/provider, without exception, shall indemnify and save harmless the School Board, its officers, agents and employees from liability of any nature of kind, including cost and expenses for or on account of any copyrighted, registered, patented, or unpatented invention, process, or article manufactured or used in the provision of goods and/or services, including use by the School Board. If the supplier/provider uses any design, device, or materials covered by letters, patent, copyright, or registration, it is mutually agreed and understood without exception that the quoted price shall include all royalties or costs arising from the use of such design, device, or materials in any way involved.
21. **TRAINING:** Unless otherwise specified suppliers/providers may be required at the convenience of and at no expense to the School Board to provide training to School Board personnel in the operation and maintenance of any item purchased as a result of this invitation.
22. **ACCEPTANCE:** Products purchased as a result of this invitation may be tested for compliance with specifications. Items delivered not conforming to specifications may be rejected and returned at bidder's expense. Those items and items not delivered by the delivery date specified in accepted offer and/or purchase order may be purchased on the open market. Any increase in cost may be charged against the bidder.
23. **SAFETY WARRANTY:** Any awarded supplier/provider including dealers, distributors, and/or manufacturers shall be responsible for having complied with all Federal, State, and local standards, regulations, and laws concerning the product or service specified, and the use thereof, applicable and effective on the date of manufacture or use or date in service including safety and environmental standards as apply to both private industry and governmental agencies.

24. **WARRANTY:** The offeror agrees that, unless otherwise specified, the product and/or service furnished as a result of this invitation and award thereto shall be covered by the most favorable commercial warranty the offeror gives to any customer for comparable quantities of such products and/or services and that the right and remedies provided herein are in addition to and do not limit any rights afforded to the School Board by any other provision of the invitation/offer.

25. **AWARD:** As the best interest of the School Board may require, the School Board reserves the right to make award(s) by individual item, group of items, all or none, or a combination thereof; on a geographical basis and/or on a district wide basis with one or more supplier(s) or provider(s); to reject any and all offers or waive any irregularity or technicality in offers received. Offerors are cautioned to make no assumptions unless their offer has been evaluated as being responsive. Any or all award(s) made as a result of this invitation shall conform to applicable School Board Rules, State Board Rules, and State of Florida Statutes.

26. **VIOLATIONS:** Any violation of any of the stipulations, terms, and/or conditions listed and/or included herein may result in the offeror/bidder being removed from the School Board Bid list and the offeror/bidder being disqualified from doing business with the School Board for a period of time to be determined on a case-by-case basis.

27. For purposes of this Invitation and evaluation of responses hereto the following shall apply: unit prices shall prevail over extended prices; written matter shall prevail over typed matter; numbers spelled in word form shall prevail over Arabic numerals (“one” over “1”). When not inconsistent with context words used in the present tense include the future, words in the plural number include the singular number, and words in the singular number include the plural number. The word “shall” is always mandatory and not merely directory.

28. **GENERAL INFORMATION ABOUT THE DISTRICT:** The District and its governing board were created pursuant to Section 4, Article IX of the Constitution of the State of Florida. The District is an independent taxing and reporting entity managed, controlled, operated, administered, and supervised by School District Officials in accordance with Chapters 1000-1013, Florida Statutes. The Board consists of five elected officials responsible for the adoption of policies, which govern the operation of the District public schools. The Superintendent of Schools is responsible for the administration and management of the schools and its departments within the applicable parameters of state laws, State Board of Education Rules, and School Board policies. The Superintendent is also specifically delegated the responsibility of maintaining a uniform system of records and accounts in the District by Section 1010.01, Florida Statutes as prescribed by the State Board of Education.

The District is coterminous with Osceola County. The annual budget for the District for 2007-2008 school year totals \$999,422,956, including an operating budget of \$461,355,469, and a capital budget of \$401,140,409.

The District operates thirty-nine schools, which includes twenty -one (21) elementary schools, seven (7) middle schools, eight (8) high schools, two (2) K thru 8 schools, and one (1) 6th thru 12th grade school. The District is also responsible for twelve alternative education sites, and seven charter schools. The total full-time K-12 projected enrollment of public school students for August 2007 is 53,070. Growth is projected to continue in the future at an average of 2000 students per year.

29. **UNIFORM COMMERCIAL CODE:** The Uniform Commercial Code (Florida Statutes, Chapter 672) shall prevail as the basis for contractual obligations between the awarded Contractor and the School District of Osceola County for any terms and conditions not specifically stated in this Invitation To Bid.

30. **AVAILABILITY OF FUNDS**
The obligations of the School District of Osceola County under this award are subject to the availability of funds lawfully appropriated for its purpose by the State of Florida and the School Board. All purchases are contingent upon available District funding.

31. **NO CONTACT: Vendors, contractors, consultants, or their representatives shall not meet with, speak individually with, or otherwise communicate with School Board members, the Superintendent, or School District staff, other than the designated purchasing agent, and School Board members, the Superintendent, or School District staff, other than the designated purchasing agent, shall not meet with, speak individually with, or otherwise communicate with vendors, contractors, consultants, or their representatives, about potential contracts with the School Board once an invitation to bid, request for quote, request for proposal, invitation to negotiate, or request for qualifications has been issued.**

Any such communication shall disqualify the vendor, contractor, or consultant from responding to the subject invitation to bid, request for quote, request for proposal, invitation to negotiate, or request for qualifications. (SCHOOL BOARD RULE SECTION 7.70.I.G)

32. **DEFINITIONS:**

BIDDER – The term “bidder” used herein refers to any dealer, manufacturer, representative, distributor, or business organization that will be or has been awarded a contract and/or purchase order pursuant to the terms and conditions of the invitation and accepted offer.

OFFEROR – The term “offeror” used herein refers to any dealer, manufacturer, representative, distributor, or business organization submitting an offer to the County in response to this invitation.

SCHOOL BOARD – The term “School Board” herein refers to the School Board of Osceola County, Florida, and its duly authorized representatives and any school, department, or unit within the School District.

USING AGENCY – The term “using agency” used herein refers to any school, department, committee, authority, or another unit in the School District using supplies or procuring contractual services as provided for in the Purchasing Department of the School District.

THE SCHOOL BOARD RESERVES THE RIGHT TO REJECT ANY OR ALL OFFERS, TO WAIVE INFORMALITIES, AND TO ACCEPT ALL OR ANY PART OF ANY OFFER AS MAY BE DEEMED TO BE IN THE BEST INTEREST OF THE SCHOOL BOARD

The purpose of this Invitation To Bid (ITB) is to solicit competitive sealed Bids to furnish **Fencing, Materials and Installation** for the use of The School District of Osceola County, Florida.

1.0 SCOPE

1.01 This Specification establishes the minimum requirements for this solicitation, listed and described in the body of these specifications, to be used as noted, by The School District of Osceola County.

1.02 AWARD TERM

The School Board's goal is to promote partnership relationships within the policies and procedures of public procurement. Pursuant toward that end, the successful bidder(s) shall be awarded a contract for an initial three year term with one subsequent two year renewal.

The award term recommendation will be that which is determined to be in the best interest of the School Board. All renewals will be contingent upon mutual written agreement and, when applicable, approval of School Board.

1.03 PRODUCTS OR SERVICES TO BE PROVIDED, AND APPLICABLE SPECIFICATIONS

LOT 1 – MATERIAL ONLY

1.03.1 Bids for Lot 1 are being accepted on Material Only. All installation for materials purchased using Lot 1 of this bid shall be accomplished by the School District of Osceola County. All materials shall meet or exceed the following minimum specifications. All galvanized pipe shall be schedule 40.

1.03.2 ITEMS #1, 2, 3, 4, & 5

Chain link, no copper used, basic open hearth steel wire, hot dip galvanized after weaving. Fabric shall be #9 gauge wire woven 2" mesh with top and bottom selvage knuckled. Mesh wire shall have tensile strength of 85,000 PSI; zinc coating shall be a minimum of 1.2 oz. per square foot of bare wire, and stand six (6) one minute dips by Preece Test (per ASTM).

1.03.3 ITEMS 6 & 7

Fabric-Polyvinyl Chloride (PVC) coated steel chain link fencing per ASTM-F 668. Type 2B steel core wire shall be 9 gauge X 2" knuckled top and bottom.

1.03.4 ITEM #8

1 5/8" O.D. steel pipe, hot dip galvanized, weighing a minimum of 2.27 pounds per foot nominal and joined with expansion sleeve connectors.

1.03.5 ITEM #9

1 5/8" O.D. Vinyl SS-40 pipe, hot dip galvanized, weighing a minimum of 1.91 pounds per foot. Top rail 21 ft. in length joined with 1 5/8" vinyl sleeve.

1.03.6 ITEM #10

1.90" O.D Steel pipe, hot dip galvanized weighing a minimum 2.72 pounds per foot.

1.03.7 ITEM #11

2-3/8" O.D Steel pipe, hot dip galvanized weighing a minimum 3.65 pounds per foot.

1.03.8 ITEM #12

2" O.D. Vinyl, SS-40 Pipe, 1.90", hot dip galvanized weighing a minimum of 2.37 pounds per foot. Line posts set 10 ft. on center maximum spacing.

1.03.9 ITEM #13 & 14

2 ½" O.D, Vinyl, SS-40 Pipe, 1.90", hot dip galvanized weighing a minimum of 3.23 pounds per foot. Line posts set 10 ft. on center maximum spacing. Concrete footing: 10" diameter, 36" depth.

LOT 2 – FURNISH AND INSTALL

1.03.10 Work will include fence framework, fabric and accessories in either all galvanized or all vinyl systems.

- Excavation for post bases.
- Concrete anchorage for posts and center drop for gates.
- Manual gates and related hardware.

1.03.11 The contractor shall provide all labor, materials, equipment, and supervision necessary for the provision and installation of fencing, gates and related equipment as specified on purchase orders issued by the District and in accordance with the procedures and materials specified herein. The Contractor must have the capability to service multiple locations within the District limits at any given time.

1.03.12 REFERENCES ASTM

These are the reference ASTM codes that you are to comply with, unless there has been a revision that has not been listed below.

392-96 Specifications for Zinc-Coated Steel Chain-link Fence Fabric

F 567-00 Practice for Installation of Chain-link Fence

F 626-96A Specifications for Fence Fittings

F 668-99A Specifications for Poly (Vinyl Chloride)
(PVC)-Coated Steel Chain Link Fence Fabric

F 1043-00 Specifications for Strength Requirements of Metal Posts and Rails for
Industrial Chain Link Fence

F 900-94 Specifications for Industrial and Commercial Swing Gates

F 934-96 Specifications for Standards Colors for Polymer-Coated Chain Link Fence
Materials

F 1083-97 Specifications for Pipe, Steel, Hot-Dipped Zinc-Coated (Galvanized)
Welded, for Fence Structures

1.03.13 QUALITY ASSURANCE

- The awarded bidder must be specializing in commercial quality chain link fencing with the company having a minimum five (5) years experience under the present name.
- Installation-ANSI/ASTM F567

1.03.14 SUBMITTALS AFTER AWARD OF CONTRACT

Work orders may require the Contractor to provide plans for the layout, grid, spacing of components, accessories, fittings hardware, anchorage's, and manufacture's installation instructions when requested by the District Representative.

An itemized quote, broken down according to the bid price sheet, is required prior to the issuance of a purchase order.

1.03.15 MATERIALS (SEE ATTACHMENT A)

- Framework-ASTM F1043, Schedule 40 Steel or SS-40 pipe, standard weight. Size and weight as specified in this specification.
- Framework-PVC/Poly coated, ASTM F669; Schedule 40 steel or SS-40 pipe, standard weight, and color to match.
- Frame material-Galvanized or vinyl coated to match fabric (**SEE ATTACHMENT A**), All fencing shall have top rail, and Intermediate and bottom rail as indicated (**SEE ATTACHMENT A**).

- Fabric-Galvanized, Zinc-coated steel chain link fence fabric per ASTN-A392. 9 Gauge X 2" mesh knuckled top and bottom.
- Fabric-Polyvinyl Chloride (PVC) coated steel chain link fencing per ASTM-F 668. Type 2B Steel core wire shall be 9 gauge X 2" knuckled top and bottom.
- Colors available-Forest Green, Black, and Brown. Color will be specified on the work order.
- All fencing shall have 7-gauge tension wire at bottom.

1.03.16 CONCRETE

- Provide concrete consisting of Portland cement per ASTM C150 aggregates per ASTM C33, and potable water. Mix materials to obtain concrete with a minimum 28 days compressive strength 3000 p.s.i. Use at least four sacks of cement per cubic yard, 1" maximum size aggregate, 3" maximum slump.
- Package concrete mix. Mix dry package normal weight concrete conforming to ASTM C387 with potable water to obtain a 2" to 3" slump.

1.03.17 GATES

Fabrication-Assemble gate frames by welding connections. Use the same fabric as for fence, unless otherwise specified. Install fabric with stretcher bars (and tie wires at top and bottom if stretcher bars are not used). Attach hardware with rivets or by other means, which provide security against removal or breakage.

- Over 8 ft. wide provide horizontal and vertical members to ensure proper gate operations and for attachment for fabric, hardware, and accessories.
- Provide minimum of 3", maximum of 5" clear space at bottom of knuckled down mesh and asphalt drive, or just above concrete curb.

Gate Hardware-Galvanized per ASTM F626 (each gate)

- Hinges-Pressed steel of malleable iron to suit gate size, non-lift off type. Provide 2 hinges per leaf.
- Latch-Forked type to permit operation from either side of gate.
- Provide padlock eye as integral part of the latch.
- Keeper-Provide keeper for gates, which automatically engages the gate leaf and holds it in the open position until manually released.
- Double Gates-Provide drop rod to hold inactive leaf. Provide pipe to engage the center drop rod. Provide locking device and padlock eyes as integral of the latch, requiring one padlock for locking both gate leaves.

1.03.18 ACCESSORIES-FINISH TO MATCH FRAMING & FABRIC

- Comply with ASTM F626 plus finish to match framing
- Tension and Tie Wire:
 1. Tension wire, use 7 gauge wire on bottom fabric
 2. Fabric to line posts, rails and braces, use 9 gauge to match fabric
 3. Fabric to tension wire, use 9 gauge hog rings to match fabric
- Post Tops-Designed as a drive fit, weather tight closure cap on tubular posts.
 1. Where top rail is used, provide tops to permit passage of the top rail.
- Stretcher Bars-One piece lengths to full height of fabric with a minimum cross section of 3/16" X 3/4". Provided stretcher bars for each gate, end, corner, and pull post.
 1. Stretcher Bar Bands and Clips: Heavy pressed steel or malleable iron.

1.03.19 EXECUTION

Installation

- Install framework fabric, accessories and gates in accordance with ANSI/ASTM F567.
- Provide fence of height and length indicated on the work order.
- Space terminal gate and other posts plumb, in concrete footing with top of footing 1" above finish grade. Slope top of concrete for water runoff. Excavation depth as required by ANSI/ASTM F567.

- Provide top rail through line post tops and splice with 6" long rail sleeves.
- Brace each gate and corner post back to adjacent line post with horizontal center brace rail and 3/8" diagonal truss rods.
- Stretch fabric between terminal posts or at intervals of 100' maximum, whichever is less.
- Position bottom of fabric 2" above finish grade.
- Fasten fabric to top of rail, braces, and bottom tension wire with wire ties maximum 24" on center and to line post at maximum 15" on center.
- Attach fabric to end, corner, and gateposts with tension bars and tension bar clips.
- Install bottom tension wire stretch taut between terminal posts.
- Install gates with fabric to match fence. Install two hinges per leaf, latch, and catches.
- Provide concrete center drop to foundation depth and drop rod retainers at center of double gate openings.

1.03.20 FIELD INSPECTION AND QUALITY CONTROL

- The District shall have access to the work at all times.
- The Project Manager shall have the authority to reject work, which does not meet the requirements specified therein.

1.03.21 USE PREMISES

- During the progress of the specified work, the Contractor shall keep the premises free from accumulation of waste materials, rubbish, and other debris resulting from the work. At the completion of the work, the Contractor shall remove all waste materials, rubbish and debris from, and about the premises as well as all tools, appliances, construction equipment, and machinery, and surplus materials, and leave the site clean. They shall restore to their original condition those portions of the site not designated for alteration by the Contract Documents.

1.03.22 SAFETY & PROTECTION

- The Contractor shall be solely and completely responsible for initiating, maintaining, and supervising all safety precautions and programs in connection with the work. The Contractor shall take all necessary precautions for the safety of, and shall provide the necessary protection to prevent damage, injury, or loss.
- All employees on the work site and other persons including, but not limited to the general public who may be affected thereby.
- All the work and all materials or equipment to be incorporated therein, whether in storage on or off the site, and other property at the site, adjacent thereto, or utilized by the Contractor including but not limited to trees, shrubs, lawn walks, pavements, roadways, structures, underground facilities, and utilities not designated for removal, relocation, or replacement in the course of construction regardless of whether or not such other property is indicated in the Contract Documents.

1.03.23 The bid amounts specified herein are for fixed price lump sum work, which includes all prices for equipment, labor, and material required to perform the work specified in the bid.

1.03.24 The bidder having examined carefully the specifications consisting of the terms and conditions herein, proposes to furnish all labor, materials, equipment and other items, facilities and services, without exception for the proper execution and completion of the contract, and if awarded the contract, to complete the said work within time limits as specified for the following bid prices.

1.03.25 LICENSES AND PERMITS

It shall be the responsibility of the successful bidder to obtain, at no additional cost to the District, any and all licenses and permits required to complete this contractual service. The licenses and permits shall be readily available for review by the District's designated representative. Where new installation is required a no cost permit provided through the Districts permitting office must be applied for by applied for by the awarded bidder(s).

1.04 DELIVERY TERMS

A. DELIVERY TIME

Lot 1, Material Only - Delivery, as specified herein, shall be within forty-eight (48) hours from the date of the receipt of the Purchase Order. If unable to meet this delivery, please specify best possible delivery schedule on bid price sheet.

Lot 2, Furnish and Install - Delivery, as specified herein, shall be within seventy-two (72) hours from the date of the receipt of the Purchase Order. If unable to meet this delivery, please specify best possible delivery schedule on bid price sheet.

B. DELIVERY CHARGES

Bid price for Lot 1 must include all delivery charges.

C. DELIVERY AND INSTALLATION CHARGES

Bid price for Lot 2 must include all delivery and installation charges.

D. HOURS OF DELIVERY

Deliveries shall be made between the hours of 8:00 a.m. and 3:00 p.m. except on Saturdays, Sundays, or holidays when all school buildings and the Warehouse are closed.

E. NOTIFICATION OF DELIVERY

The School Board Representative must be notified at least twenty-four (24) hours in advance of delivery.

F. F.O.B. POINT

The F.O.B. point for this contract and for all purchases made under it shall be as specified by the using school/department (in accordance with the Bid Submittal Form), in the school district. Delivery will not be complete until the using school/department has accepted each item. Delivery to a common carrier shall not constitute delivery to the ordering agency. All disputes shall be between the seller/bidder and the carrier.

1.05 MINIMUM ORDERS

If a bidder wishes to set a minimum order dollar amount, they must do so by indicating the dollar amount in the space provided on the Price Sheet. Failure to specify will be considered no minimum dollar amount.

1.06 LABELING

Each carton, package, box and/or container shall be labeled. Each label shall identify each carton as follows:

- A. Name of item.
- B. Quantity of item contained.
- C. Purchase Order Number.
- D. Company.

1.07 DAMAGED ITEMS

In the event an item or items is received and it is later determined there is concealed damage when the item or items is unpacked, the item or items must be replaced by the awarded bidder at no cost to the School Board.

1.08 INSTALLATION – LOT 2

The successful bidder shall deliver, set in place, install, the items herein specified. The bidder shall provide a qualified person, at no extra cost, to assure proper installation of the items herein specified. Upon completion of installation, the authorized representative of the School Board shall accept it.

1.09 QUANTITY

The estimated quantities that will be purchased during the first twelve (12) months of this contract are shown on the Bid Price Sheet. Please note that these are estimates only and in no way obligates the School Board to purchase these amounts. These estimates are intended as a guide in submitting your bid. The actual quantities purchased under this bid may be more or may be less.

1.10 QUANTITY CHANGES

The School Board reserves the right to increase or decrease the total quantities necessary.

1.11 METHOD OF ORDERING

Items shall be order via individual purchase orders on an "as needed" basis for the term of the contract. Invoices must be submitted against each individual purchase order.

1.12 ORDERS

Schools, departments and centers of the School District of Osceola County will issue purchase orders directly to the successful bidder(s) for the purchase of Fencing. The successful bidder(s) will be expected to honor these orders according to the discount terms and conditions listed in this bid. Each purchase order will be faxed or mailed to the awarded bidder. The order should be reviewed for correct prices, catalog numbers, extensions, etc.

1.13 EXEMPT FROM THIS BID

Purchases shall not include items available at lower prices on other School District bid awards or on Florida State Contracts. The School District reserves the right to bid separately any item if deemed to be in the best interest of the District.

1.14 SUBSTITUTES

Unapproved substitutes will not be allowed. If items are not available, the school or department noted on the purchase order must be contacted prior to shipment to determine if a substitute is acceptable.

1.15 LIQUIDATED DAMAGES

In case of failure on the part of the Bidder to complete the work within the time(s) specified in the Contract, or within such additional time(s) as may be granted by formal action of the School District of Osceola County or fails to prosecute the work, or any separable part thereof, with such diligence as will ensure its completion within the time(s) specified in the contract or any extensions thereof, the School District of Osceola County will suffer damage, the amount of which is difficult, if not impossible to ascertain. Therefore, the Bidder shall pay to the District, as liquidated damages, the sum of \$100.00 for each calendar day of delay that actual completion extends beyond the time limit specified until such reasonable time as may be required for final completion of the work. In no way shall costs for liquidated damages be construed as a penalty on the Bidder.

1.16 NO DAMAGES FOR DELAY

Bidder is not entitled to any additional compensation or increase in the contract sum for direct, indirect, impact, or any other damages arising because of any hindrance or delays caused by the owner or any other cause whatsoever. Bidder's only remedy for delay, not caused or exacerbated by the Bidder, shall be an extension of time to complete the Bidder's scope of work. Any extension of time shall be granted at the sole discretion of the School Board, and if granted, shall be in the form of additional days added to the contract.

1.17 BARRICADES

The Bidder shall provide all barricades and take all necessary precautions to protect building and personnel. All work shall be complete in every respect and accomplished in a workmanlike manner and Bidder shall provide for removal of all debris from the School District of Osceola County.

1.18 PALLETIZE

Shipment(s) must be palletized. Pallets are available for exchange at the time of delivery, if required.

2.0 STANDARD TERMS & CONDITIONS

2.01 CLOSING DATE

Bids must be received by The School District of Osceola County Purchasing Department, Building 2000, 817 Bill Beck Blvd., Kissimmee, FL, 34744-4495, no later than **2:00 p.m., local time, on Wednesday, September 3, 2008.** Bids received after this time will not be considered.

2.02 TENTATIVE SCHEDULE

August 6, 2008 Invitation To Bid Available
August 20, 2008 Pre-bid Conference
September 3, 2008 Bid Closing Date
September 16, 2008 Planned Award Date

2.02 DELIVERY OF BIDS

All Bids shall be sealed and delivered or mailed to (faxes/e-mails will not be accepted):
The School District of Osceola County, Florida
Purchasing Department, Building 2000
817 Bill Beck Blvd.
Kissimmee, Florida 34744-4495

Mark package(s) "**Bid #SDOC 09-B-007 CJ, FENCING, MATERIALS AND INSTALLATION**" and **insure that bidders return address is listed on the outside of the package.**

Note: Please ensure that if a third party carrier (Federal Express, Airborne, UPS, USPS, etc.) is used, that the third party is properly instructed to deliver the Bid Submittal **only** to the Purchasing Department, Building 2000 at the above address. To be considered, **a Bid must be received and accepted in the Purchasing Department before the Bid closing date and time.**

2.03 PRE-BID CONFERENCE

- A. A pre-bid conference will be held in the Purchasing Department Conference Room, 817 Bill Beck Blvd., Building 2000, Kissimmee, Florida, at 9:00 a.m., local time, Wednesday, August 20, 2008. While this is not mandatory, all interested parties are encouraged to attend and participate.
- B. Individuals covered by the Americans with Disabilities Act of 1990 in need of accommodations to attend public Bid openings or meetings should contact the School District Purchasing Department in Kissimmee 407.870.4630 at least five (5) days prior to the meeting date.

2.04 PUBLIC BID OPENING

- A. The Bids will be available for inspection during normal business hours in the Purchasing Department within ten (10) days of the closing date, by appointment (Florida Statute 119.071 (1) (b)).
- B. A copy of the completed bid tabulation will be available on the Purchasing Department web page at www.osceola.k12.fl.us/depts/Purchasing/Index.asp within ten (10) days.
- C. Individuals covered by the Americans with Disabilities Act of 1990 in need of accommodations to attend public Bid openings or meetings should contact the Purchasing Department at 407.870.4625 at least five (5) days prior to the meeting date.

2.05 BID SUBMITTAL FORM

- A. See **Submittal Requirements** for complete details.
 - B. Note: **It is not necessary to return every page of this document with the bid proposal; return only the pages that require signatures or information.**
 - C. Each bidder shall submit Three (3) complete sets of the Bid Submittal:
 - **One (1)** hard copy marked "ORIGINAL"
 - **One (1)** hard copies marked "COPY"
 - **One (1) COMPLETE electronic copy on a CD in PDF format (Excel spreadsheets shall not be recorded in PDF).**
Note the solicitation number and name of company on the disk.
- If a Non-Disclosure Agreement is signed and confidential materials are submitted, such confidential materials shall not be included on the master CD. Confidential materials shall be segregated on a separate CD, plainly labeled "Confidential Materials".**
- D. The Invitation To Bid page and other required documents must be signed by an official authorized to legally bind the bidder to all bid provisions.
 - E. Terms and conditions differing from those in this Bid shall be cause for disqualification of the Bid Submittal.

2.06 QUESTIONS CONCERNING BID

- A. Questions concerning any portion of this Bid shall be directed in writing or by e-mail to the Purchasing Representative named below, who shall be the official point of contact for this Bid. Questions should be submitted at least **seven (7) days** prior to the closing date.
- B. Mark cover page or envelope(s) **"Questions on Bid # SDOC 09-B-007 CJ, FENCING, MATERIALS AND INSTALLATION"**
- C. Submit questions to:
Cheryl Jessee
Telephone:407.870.4627
Fax:.....407.870.4616
E-mail:jesseec@osceola.k12.fl.us

2.07 CLARIFICATION AND ADDENDA

- A. It is incumbent upon each bidder to carefully examine all specifications, terms, and conditions contained herein. Any inquiries, suggestions, or requests concerning interpretation, clarification or additional information shall be made in writing, (facsimile transmissions acceptable, 407.870.4616) through the Purchasing Representative named above. The School Board will not be responsible for any oral representation(s) given by any employee, representative or others. The issuance of a written addendum is the **only** official method by which interpretation, clarification or additional information can be given.
- B. If it becomes necessary to revise or amend any part of this Bid, notice may be obtained by accessing our web site. The bidder in the Bid Submittal must acknowledge receipts of amendments. **Each bidder should ensure that all addenda and amendments to this Bid have been received BEFORE submitting the Bid. Check the Purchasing Department web site at www.osceola.k12.fl.us/depts/Purchasing/Index.asp for any addenda. The Purchasing Department will not manually distribute any addendum.**

2.08 AWARD

The School Board reserves the right to award the contract to the bidder(s) that the Board deems to offer the lowest responsive and responsible bid(s), as defined elsewhere in this solicitation. The Board is therefore not bound to accept a bid on the basis of lowest price. In addition, the Board has the sole discretion and reserves the right to cancel this Bid, to reject any and all bids, to waive any and all informalities and/or irregularities, or to re-advertise with either the identical or revised specifications, if it is deemed to be in the best interest of the Board to do so. The Board also reserves the right to make multiple awards based on experience and qualifications or to award only a portion of the items and/or services specified, if it is deemed to be in the Board's best interest.

2.09 PAYMENT DISCOUNTS

A bid price submitted indicating a discount if an invoice is paid within a certain number of days from the date of the invoice cannot be considered as a basis for the bid evaluation. All bid prices must be net and not contingent on terms.

2.10 DEFINITION OF RESPONSIVE AND RESPONSIBLE FOR THIS BID

Each bid submittal shall be evaluated for conformance as responsive and responsible using the following criteria:

- A. Proper submittal of ALL documentation as required by this bid. (Responsive)

- B. The greatest benefits to the School District as it pertains to: (Responsible)
 - 1. Total Cost
 - 2. Delivery
 - 3. Past Performance. In order to evaluate past performance, all bidders are required to submit:
 - a. A list of references with the bid and;
 - b. A list of relevant projects completed within the last 3 years that are the same or similar to the magnitude of this ITB.
 - 4. All technical specifications associated with this bid.
 - 5. Financial Stability: Demonstrated ability, capacity and/or resources to acquire and maintain required staffing.
 - 6. **Required licenses and proof of length of time in business under current business name.**

Bidders are reminded that award may not necessarily be made to the lowest bid. Rather, award will be made to the lowest responsive, responsible, bidder whose bid represents the best overall value to the School District when considering all evaluation factors.

2.11 OTHER AGENCIES

- A. All bidders awarded contracts from this Bid may, upon mutual agreement with the other agency, permit any school district/board, municipality or other governmental agency to participate in the contract under the same prices, terms and conditions, if agreed to by both parties.

- B. Further, it is understood that each school district/board or agency will issue its own purchase order to the awarded bidder(s).

2.12 ASSIGNMENT

The awarded bidder shall not assign, transfer, convey, sublet, or otherwise dispose of any award or of any of its rights, title, or interests therein, without the prior written consent of the School Board. The School Board shall approve any requests for assignments and/or sub-letting contracts prior to responding to such requests.

2.13 CONTRACT

- A. The contents of this Bid and all provisions of the successful bidder's Submittal Form shall be considered a contract and become legally binding. A separate contract document, other than the purchase order, will not be issued.

- B. The Director of Purchasing and Warehouse, Superintendent, and Board Chair are the sole Contracting Officers for the School Board, and only they or their designee are authorized to make changes to any contract.
- C. The School Board shall be responsible for only those orders placed by the schools/departments on an authorized signed Purchase Order. The School Board shall not be responsible for any order, change substitution or any other discrepancy on the Purchase Order. If there is any question about the authenticity of a Purchase Order or change order, the bidder should promptly contact the Purchasing Department.

2.14 DISCLOSURE OF BID CONTENT

- A. All material submitted becomes the property of the School Board and may be returned only at the School Board's option. The School Board has the right to use any or all ideas presented in any reply to this Bid. Selection or rejection of any Bid Submittal does not affect this right.
- B. The School Board is governed by the Public Record Law, Chapter 119, Florida Statutes (F.S.). Only trade secrets as defined in Section 812.081(1)(c), F.S. or financial statements required by the School Board as defined in 119.071(1)(c), F.S. (hereinafter "Confidential Materials"), may be exempt from disclosure. If a respondent submits Confidential Materials, the information **must be segregated**, accompanied by an executed Non-disclosure Agreement for Confidential Materials and each pertinent page must be clearly labeled "confidential" or "trade secret." The School Board will not disclose such Confidential Materials, subject to the conditions detailed within the Agreement, which is attached to this solicitation. When such segregated and labeled materials are received with an executed Agreement, the School Board shall execute the Agreement and send the respondent a "Receipt for Trade Secret Information."

RETURN THIS FORM *ONLY* IF CONFIDENTIAL MATERIALS ARE BEING INCLUDED IN THE SUBMITTAL. PLEASE READ THE SECTION IN THE BID DOCUMENT TO DETERMINE IF THIS APPLIES.

2.15 BIDDER'S RESPONSIBILITY

The bidder, by submitting a Bid represents that:

- A. The bidder has read and understands the Invitation To Bid in its entirety and that the Bid is made in accordance therewith, and;
- B. The bidder possesses the capabilities, resources, and personnel necessary to provide efficient and successful service to the School Board, and;
- C. Before submitting a Bid, each bidder shall make all investigations and examinations necessary to ascertain site and/or local conditions and requirements affecting the full performance of the contract and to verify any representations made by the School Board, upon which the bidder will rely. If the bidder receives an award because of its Bid Submittal, failure to have made such investigations and examinations will in no way relieve the bidder from its obligations to comply in every detail with all provisions and requirements of the contract, nor will a plea of ignorance of such conditions and requirements be accepted as a basis for any claim by the bidder for additional compensation or relief.
- D. The bidder will be held responsible for any and all discrepancies, errors, etc., in discounts or rebates which are discovered during the contract term or up to and including five (5) fiscal years following the School Board's annual audit.

2.16 PAYMENT TERMS

A. INVOICING

The successful bidder will be required to submit invoices and reference purchase order numbers on all requests for payment. All statements must reference valid SDOC purchase order numbers. Invoices shall be mailed directly to: Accounts Payable, School District of Osceola County, 817 Bill Beck Blvd., Kissimmee, Florida 34744-4495. A separate invoice must be received for each purchase order number. Payment for partial shipments shall not be made unless specified. Invoices, which do not reference valid SDOC, purchase order numbers or which are erroneous (incorrect contract prices, minimum order charges, etc.) shall be returned to the vendor for resolution of the discrepancies. It is the sole responsibility of the vendor to reconcile the purchase order and the vendor's invoice and to notify the purchasing representative of any discrepancies prior to billing. The school board will only pay the dollar amounts authorized on the purchase order.

B. The School Board will remit full payment on all undisputed invoices within forty-five (45) days from receipt by the appropriate person(s) (to be designated at time of contract) of the invoice(s) or receipt of all products or services ordered.

C. Pursuant to Chapter 218, Florida Statutes, the School Board will pay interest, not to exceed one percent (1%) per month, on all undisputed invoices not paid within forty-five (45) days after receipt of the entire order of the commodity or service, AND a properly completed invoice, whichever is later.

D. The School Board has the capabilities of Electronic Fund Transfer (EFT). List any additional discounts for payment using Electronic Funds Transfer (EFT) and/or any additional discounts to be applied to such payments.

E. ***By submitting a Bid (offer) to the School Board, the bidder expressly agrees that if awarded a contract, the School Board may withhold from any payment, monies owed by the bidder to the School Board for any legal obligation between the bidder and the School Board.***

F. Partial payments in the full amount of the value of items received and accepted may be requested by the submission of a properly executed invoice with support documents if required.

2.17 CERTIFICATES

The School Board reserves the right to require proof that the bidder is an established business and is abiding by the ordinances, regulations, and laws of their community, the county, and the State of Florida, such as but not limited to: Business Tax Receipts, Business Licenses, Florida Sales Tax Registration, Federal Employers Identification Number.

2.18 INSURANCE, LICENSES AND CERTIFICATES

The bidder agrees to provide and maintain at all times during the term of this agreement, without cost or expense to the School Board, policies of insurance insuring the bidder against any and all claims, demands or causes of action whatsoever, for injuries received or damage to property relating to the performance of duties, services and/or obligations of the bidder under the terms and provisions of this agreement. The bidder will provide the School Board with copies of current appropriate business licenses.

2.19 INSURANCE

The bidder shall secure and maintain, at its sole cost and expense during the contract term, the following insurance:

- Commercial General Liability – in the amount of \$3 million aggregate / \$1 million per occurrence.

- Liability – Auto, in the amount of \$100,000/300,000 / Any Auto
- Workers Compensation – As required by Florida law.

Requirements for bidders that qualify for an exemption under the Florida Worker's Compensation law in Chapter 440 Florida Statutes are detailed below:

Incorporated or unincorporated firms with fewer than four employees shall be required to sign a Hold Harmless Agreement relieving the School Board of liability in the event they and/or their employees are injured while providing goods and/or services to the School Board.

Incorporated or unincorporated firms with four or more employees shall be required to provide a copy of their "Notice of Election to be Exempt", along with valid proof of coverage for non-exempt employees.

The Hold Harmless Agreement mentioned above is included as an attachment to this bid. Said Agreements shall be returned with the bid proposal as detailed in the Submittal Requirements.

The School Board reserves the right to request a copy of the complete insurance policy(ies) and any endorsements for the insurance referenced above. A certificate of insurance indicating that the bidder has coverage in accordance with the requirements herein set forth shall be furnished by the bidder to the School Board Representative prior to the execution of the contract and annually upon renewal thereafter. **The Bidder shall either cover any subcontractors on its policy or require the subcontractors to obtain coverage to meet all requirements for insurance contained herein.**

Bidder agrees that School Board will make no payments pursuant to the terms of the contract until all required proof or evidence of insurance has been provided to the School Board Representative. Bidder agrees that the insurer shall waive its rights of subrogation, if any, against the School Board on Commercial General Liability and Workers Compensation insurance coverage. The ACORD certificate of Liability Insurance, with endorsements shall be completed by the authorized Resident Agent and returned to the Purchasing Department. This certificate shall be dated and show:

- A. The name of the insured bidder, the specified job by name, name of the insurer, the number of the policy, its effective date and its termination date.
- B. Statement that the Insurer will mail notice to the School Board at least thirty (30) days prior to any material changes in provisions or cancellation of the policy.
- C. School Board shall be named as an additional insured on Commercial General Liability Insurance.**

Loss Deductible Clause: The School Board shall be exempt from, and in no way liable for, any sums of money that may represent a deductible in any insurance policy. The payment of such deductible shall be the sole responsibility of the bidder and/or sub-consultant providing such insurance.

2.20 SAFETY

The bidder shall take the necessary precautions and bear the sole responsibility for the safety of the methods employed in performing the work. The bidder shall at all times comply with the regulations set forth by federal, state, and local laws, rules, and regulations concerning "OSHA" and all applicable state labor laws, regulations, and standards. Bidder shall take all necessary precautions to ensure all materials provided do not include Asbestos. The bidder shall indemnify and hold harmless the School Board from and against all liabilities, suits, damages, costs, and expenses (including attorney's fees and court costs) which may be imposed on the School Board because of the bidder, sub-contractor, or supplier's failure to comply with the regulations.

2.21 PRICE REDETERMINATION - FUEL

The bidder may petition the Director of Purchasing and Warehouse for price redetermination if/when the price of fuel increases by a minimum of ten (10%) percent. Any price redetermination will be solely based upon changes as documented by the Producer Price Index (PPI) for the commodity "Gasoline - WPU0571" or "#2 diesel fuel - WPU057303" as published by the Bureau of Labor Statistics, which can be found on-line at <http://stats.bls.gov>. The base index number will be the month of June 2008. Subtracting the base index number from the current index number and dividing the result by the base index number calculates the maximum percentage increase allowed. Any price redetermination will include all items awarded. If the School Board and the bidder cannot agree on any price redetermination, then the contract will expire. Bidders shall provide documentation to illustrate what percentage of the price is related to fuel, as the increase shall be calculated based upon the percentage of the cost associated to the cost of fuel (see example below). Failure to provide the detailed cost analysis with each request for a price redetermination due to fuel price escalation shall preclude any price redetermination due to fuel costs.

Example:

- Fourteen (14%) percent of the cost to provide product/service is attributed to the cost of fuel.
- PPI in the month the solicitation closed was \$281.40 \$300.00
- Current PPI is \$300.00 -\$281.40
- \$18.60
- \$18.60 divided by \$281.40 = .066%
- The unit cost of the product/service is \$100.00
- 14% of \$100.00 = \$14.00
- \$14.00 x .066% = \$.92
- New unit price for the product/service is \$100.92

If the School Board grants an increase in the contract price based upon increases in gasoline and/or diesel prices, then the Board may also adjust the contract price downward if the cost of gasoline and/or diesel decreases by ten percent (10%) or more from the date of the last increase in the contract price.

This clause may be used in addition to any other price redetermination clause in this invitation.

If the School Board and the bidder cannot agree on any price redetermination, then the contract will expire without prejudice 30 (thirty) days after the impasse is reached.

2.22 PRICE REDETERMINATION

The bidder may petition the Director of Purchasing and Warehouse for price redetermination within sixty (60) days of the expiration of each term of the contract or on the anniversary date of the contract, whichever is specified elsewhere in this ITB. The School Board may also petition the bidder under the same guidelines. Any price redetermination will be solely based upon changes as documented by the Producer Price Index (PPI) for the commodity "Iron and steel mills" – Table 5, PCU331111" as published by the Bureau of Labor Statistics which can be found on-line at <http://stats.bls.gov>. The base index number will be the month of June 2008. The initial redetermination index number will be the index for June 2009 as published in August 2009. Subtracting the base index number from the current index number and dividing the result by the base index number calculates the maximum percentage increase allowed. For all periods after the first year, subsequent June indexes will be used. Any price redetermination will include all items awarded.

Bidders shall provide documentation to illustrate what percentage of the price for the product/service is related to the commodity, as the increase shall be calculated based upon the percentage of the cost associated to the cost of the commodity (see example below). Failure to provide the detailed cost analysis with each request for a price redetermination due to commodity price escalation shall preclude any price redetermination requests relating to commodity costs.

Example:

- Eighty-six (86%) percent of the cost to provide product/service is attributed to the cost of the commodity.
- PPI in the month the solicitation closed was \$193.90 \$300.00
- Current PPI is \$300.00 -\$193.90
- \$106.10
- \$106.10 divided by \$193.90 = .547%
- The unit cost of the product/service is \$100.00
- 86% of \$100.00 = \$86.00
- \$86.00 x .547% = \$47.04
- New unit price for the product/service is \$147.04

If the School Board grants an increase in the contract price based upon increases in the PPI Index, then the Board may also adjust the contract price downward if the PPI Index decreases by ten percent (10%) or more from the date of the last increase in the contract price.

This clause may be used in addition to any other price redetermination clause in this invitation.

If the School Board and the bidder cannot agree on any price redetermination, then the contract will expire without prejudice thirty (30) days after the impasse is reached.

2.23 DEVIATIONS

All Bid Submittals must clearly and with specific detail, note all deviations to the exact requirements imposed upon the bidder by the specifications. Such deviations must be stated upon the Bid Submittal Form; otherwise the School Board will consider the subject Bid Submittals as being made in strict compliance with said Specifications to bidders, the bidder being held therefore accountable and responsible. Bidders are hereby advised that School Board will only consider Bid Submittals that meet the exact requirements imposed by the specifications; except, however, said Bid Submittals may not be subject to such rejection where, **at the sole discretion of The School Board**, the stated deviation is considered to be equal or better than the imposed requirement and where said deviation does not destroy the competitive character of the Bid process by affecting the amount of the Bid Submittal such that an advantage or benefit is gained to the detriment of the other bidders.

2.24 MATERIAL SAFETY DATA SHEET

In accordance with Chapter 442 of the Florida Statutes, it is the bidder's responsibility to identify and to provide to the School District Purchasing Department a Material Safety Data Sheet for any material, as may apply to this procurement.

2.25 WAIVER OF CLAIMS

Once this contract expires, or final payment has been requested and made, the awarded bidder shall have no more than thirty (30) calendar days to present or file any claims against the School Board concerning this contract. After that period, the School Board will consider the bidder to have waived any right to claims against the School Board concerning this agreement.

2.26 TERMINATION / CANCELLATION OF CONTRACT

The School Board reserves the right to cancel the contract without cause with a minimum thirty (30) days written notice.

Termination or cancellation of the contract will not relieve the bidder of any obligations for any deliverables entered into prior to the termination of the contract (i.e., reports, statements of accounts, etc., required and not received).

Termination or cancellation of the contract will not relieve the bidder of any obligations or liabilities resulting from any acts committed by the bidder prior to the termination of the contract.

The bidder may cancel the resulting contract with Ninety (90) days **written** notice to the Director of Purchasing and Warehouse. Failure to provide proper notice may result in the bidder being barred from future business with the School District.

2.27 TERMINATION FOR DEFAULT

The School District's Contract Administrator shall notify, in writing, the bidder of deficiencies or default in the performance of its duties under the Contract. Three separate documented instances of deficiency or failure to perform in accordance with the specifications contained herein shall constitute cause for termination for default, unless specifically specified to the contrary elsewhere within this solicitation. It shall be at the School Board's discretion whether to exercise the right to terminate. Bidder shall not be found in default for events arising due to acts of God.

2.28 TERMINATION FOR SCHOOL BOARD'S CONVENIENCE

The performance of work under this contract may be terminated in accordance with this clause in whole, or from the time in part, whenever the School Board representative shall determine that such termination is in the best interest of the School Board. Any such termination shall be effected by the delivery to the bidder of a Notice of Termination specifying the extent to which performance of work under the contract is terminated, and the date upon which such termination becomes effective. Upon such termination for convenience, bidder shall be entitled to payment, in accordance with the payment provisions, for services rendered up to the termination date and the School Board shall have no other obligations to bidder. Bidder shall be obligated to continue performance of contract services, in accordance with this contract, until the termination date and shall have no further obligation to perform services after the termination date.

2.29 INCURRED EXPENSES

This ITB does not commit the School Board to award a contract, nor shall the School Board be responsible for any cost or expense which may be incurred by the bidder in preparing and submitting the Submittal called for in this ITB, or any cost or expense incurred by the bidder prior to the execution of a contract agreement.

2.30 MINIMUM SPECIFICATIONS

The specifications listed herein are the minimum required specifications for this ITB. They are not intended to limit competition nor specify any particular bidder, but to ensure that the School District receives quality products and services.

2.31 COMPLIANCE WITH LAWS AND REGULATIONS

The bidder shall be responsible to know and to apply all applicable federal and state laws, all local laws, ordinances, rules, regulations, and all orders and decrees of bodies or tribunals having jurisdiction or authority which in any manner affect the work, or which in any way affect the conduct of the work. Bidder shall always observe and comply with all such laws, ordinances, rules, regulations, orders, and decrees. The bidder shall protect and indemnify School Board and all its officers, agents, servants, or employees against any claim or liability arising from or based on the violation of any such law, ordinance, rule, regulation, order, or decree caused or committed by bidder, its representatives, sub-contractors, sub-consultants, professional associates, agents, servants, or employees. Additionally, bidder shall obtain and maintain at its own expense all licenses and permits to conduct business pursuant to this contract from the federal government, State of Florida, Osceola County, or municipalities when legally required, and maintain same in full force and effect during the term of the contract.

2.32 RECORDS & RIGHT TO AUDIT

The bidder shall maintain such financial records and other records as may be prescribed by the School Board or by applicable federal and state laws, rules, and regulations. The bidder shall retain these records for a period of three (3) years after final payment, or until the School Board audits them, whichever event occurs first. These records shall be made available during the term of the contract and the subsequent three-year period for examination, transcription, and audit by the School Board, its designees, or other entities authorized by law.

2.33 CHANGES IN SCOPE OF WORK/SERVICE

- A. The School Board may order changes in the work/service consisting of additions, deletions, or other revisions within the general scope of the contract. No claims may be made by the bidder that the scope of the project or of the bidder's services has been changed, requiring changes to the amount of compensation to the bidder or other adjustments to the contract, unless such changes or adjustments have been made by written amendment to the contract signed by the School Board Chair and the bidder.

- B. If the bidder believes that any particular work/service is not within the scope of work/service of the contract, is a material change, or will otherwise require more compensation to the bidder, the bidder must immediately notify the School Board's Representative in writing of this belief. If the School Board's Representative believes that the particular work/service is within the scope of the contract as written, the bidder will be ordered to and shall continue with the work/service as changed and at the cost stated for the work/service within the scope. The bidder must assert its right to an adjustment under this clause within thirty (30) days from the date of receipt of the written order.

- C. The School Board reserves the right to negotiate with the awarded bidder(s) without completing the competitive bidding process for materials, products, and/or services similar in nature to those specified within this ITB for which requirements were not known when the ITB was released.

2.34 MODIFICATIONS DUE TO PUBLIC WELFARE OR CHANGE IN LAW

The School Board shall have the power to make changes in the contract as the result of changes in Florida law and/or ordinances of Osceola County to impose new rules and regulations on the bidder under the contract relative to the scope and methods of providing services as shall from time-to-time be necessary and desirable for the public welfare. The School Board shall give the bidder notice of any proposed change and an opportunity to be heard concerning those matters. The scope and method of providing services as referenced herein shall also be liberally construed to include, but is not limited to, the manner, procedures, operations and obligations, financial or otherwise, of the bidder. In the event any future change in Federal, State or County law or the ordinances of Osceola County materially alters the obligations of the bidder, or the benefits to the School Board, then the contract shall be amended consistent therewith. Should these amendments materially alter the obligations of the bidder, then the bidder or the School Board shall be entitled to an adjustment in the rates and charges established under the contract. Nothing contained in the contract shall require any party to perform any act or function contrary to law. The School Board and bidder agree to enter into good faith negotiations regarding modifications to the contract, which may be required in order to implement changes in the interest of the public welfare or due to change in law. When such modifications are made to the contract, the School Board and the bidder shall negotiate in good faith, a reasonable and appropriate adjustment for any changes in services or other obligations required of the bidder directly and demonstrably due to any modification in the contract under this clause.

2.35 RIGHT TO REQUIRE PERFORMANCE

- A. The failure of the School Board at any time to require performance by the bidder of any provision hereof shall in no way affect the right of the School Board thereafter to enforce same, nor shall waiver by the School Board of any breach of any provision hereof be taken or held to be a waiver of any succeeding breach of such provision or as a waiver of any provision itself.

- B. In the event of failure of the bidder to deliver services in accordance with the contract terms and conditions, the School Board, after due written notice, may procure the services from other sources and hold the bidder responsible for any resulting additional purchase and administrative costs. This remedy shall be in addition to any other remedies that the School Board may have.

2.36 FORCE MAJEURE

The School Board and the bidder will exercise every reasonable effort to meet their respective obligations as outlined in this ITB and the ensuing contract, but shall not be liable for delays resulting from force majeure or other causes beyond their reasonable control, including, but not limited to, compliance with any government law or regulation, acts of God, acts or omissions of the other party, government acts or omissions, fires, strikes, national disasters, wars, riots, transportation problems and/or any other cause whatsoever beyond the reasonable control of the parties. Any such cause will extend the performance of the delayed obligation to the extent of the delay so incurred.

2.37 BIDDER'S PERSONNEL

During the performance of the contract, the bidder agrees to the following:

- A. The bidder shall not discriminate against any employee or applicant for employment because of race, religion, color, sex, age, handicap or national origin, except when such condition is a bona fide occupational qualification reasonably necessary for the normal operations of the bidder. The bidder agrees to post in conspicuous places, visible to employees and applicants for employment, notices setting forth the provisions of this nondiscrimination clause.
- B. The bidder, in all solicitations or advertisements for employees placed by or on behalf of the bidder, shall state that such bidder is an Equal Opportunity Employer.
- C. Notices, advertisements, and solicitations placed in accordance with federal law, rule, or regulation shall be deemed sufficient for the purpose of meeting the requirements of this section.
- D. The bidder shall include the provisions of the foregoing paragraphs A, B, and C, above, in every subcontract or purchase order so that the provisions will be binding upon each bidder.
- E. The bidder and any sub-contractor shall pay all employees working on this contract not less than minimum wage specified in the Fair Labor Standards Act (29 CFR 510-794) as amended.
- F. Any information concerning the School Board, its products, services, personnel, policies or any other aspect of its business learned by the bidder or personnel furnished by the bidder in the course of providing services pursuant to the Agreement, shall be held in confidence and shall not be disclosed by the bidder or any employee or agents of the bidder or personnel furnished by the bidder, without the prior written consent of the School Board.
- G. All employees assigned by the Bidder to the performance of work under this contract shall be physically able to do their assigned work. It shall be the Bidder's responsibility to insure that all employees meet the physical standards to perform the work assigned and are free from communicable diseases. This requirement also includes acceptable hygiene habits of Bidder's employees.
- H. The personnel employed by the Bidder shall be capable employees, age 18 years or above, qualified in this type of work.
- I. It is the Bidder's responsibility to ensure that all employees are legally allowed to work in the United States in accordance with Immigration Policies.
- J. The Bidder's employees shall be required to dress neatly, commensurate with the tasks being performed.
- K. All District facilities are smoke free. Smoking on District grounds is prohibited.

- L. It is the Bidders responsibility to see that every employee on the Bidder's work force is provided and wears an Identification Badge or company shirt/uniform in order to maintain security at the school's facility. It shall be Bidder's responsibility to inform the School District Representative(s) of all new employees promptly at time of employment.
- M. The Bidder shall require employees to be dressed in their appropriate work attire when reporting for duty.
- N. The Bidder shall prohibit their employees from disturbing papers on desks, opening desk drawers or cabinets, or using telephone or office equipment provided for official use.
- O. The Bidder shall require their employees to comply with the instructions pertaining to conduct and building regulations, issued by duly appointed officials, such as the building managers, guards, inspectors, etc.
- P. The School District's Representative(s) will determine how the Bidder will receive access to the facility.
- Q. If keys are provided and lost, the Bidder will be responsible for any and all costs associated with replacement keys and re-keying of the facility.
- R. When requested, the Bidder shall cooperate with any ongoing SCHOOL BOARD investigation involving economic loss or damage to SCHOOL BOARD buildings, or SCHOOL BOARD or personal property therein. The SCHOOL BOARD reserves the right to require any employee of the Bidder to submit to a polygraph test if the SCHOOL BOARD has a reasonable suspicion that the employee is or was involved in the incident or activity under investigation. The Bidder shall obtain a waiver from the employee authorizing the release to the SCHOOL BOARD of information acquired by the Bidder from the polygraph test. The SCHOOL BOARD, at its discretion, may require that the Bidder immediately remove the employee under investigation from working within SCHOOL BOARD buildings for the following reasons: 1) The employee's refusal to submit to a polygraph test in the above circumstances, or 2) an employee's refusal to sign the waiver referenced above or 3) an analysis of the polygraph test indicates that the employee is or was involved in the incident under investigation. If the test results show involvement on the part of the Bidder's employee, the Bidder will be obligated to cover the cost of the examination. If the test results indicate that the Bidder's employee was not involved in the incident, when the SCHOOL BOARD will pay for the cost of the examination.
- S. CONTROLLED SUBSTANCE OR ALCOHOL ABUSE ON SCHOOL BOARD PROPERTY: The successful Bidder(s) is hereby notified that the unlawful manufacture, distribution, dispensation, possession or use of a controlled substance or alcohol is prohibited on any school district property, or at any school board activities. Violations may subject the Bidder and/or the Bidder's employee(s) to prosecution, fines, imprisonment and/or cancellation of this or any other contract(s) that this Bidder presently holds. The Bidder(s) are required by this school board to take appropriate disciplinary action in such cases and/or require that the employee(s) satisfactory participation in a rehabilitation program.
- T. Any Bidder's employee convicted of violating a criminal drug statute in the workplace must report the conviction to the employer within five (5) workdays. Bidders (Employers) are required to report such convictions to the school board within ten (10) workdays of receiving this information.
- U. The School District of Osceola County, Florida, is committed to the education and safety of its students and employees. To that end, any bidder awarded a contract will be required to assure that the personnel assigned to the project, do not possess criminal records that would violate the School Board's standards for employment as set forth by the Florida

Department of Education. Each bidder must certify that the company and its employees are or will be in compliance with those standards for the project awarded.

- V. The Bidder shall strictly prohibit interaction between their employees and the student(s).
- W. Bidder's employees may not solicit, distribute or sell products while on School District property.
- X. Friends, visitors or family members of the Bidder's employees are not permitted in the work area.
- Y. The Bidder shall adhere to all of the District's security standards.

2.38 COMPLIANCE WITH THE JESSICA LUNSFORD ACT

A. LEVEL 2 BACKGROUND SCREENING

In pursuant to Florida Statutes 1012.465, as modified, the School District will be required to screen any awarded vendor, their employee(s), or agent(s), and/or representative(s) who will be on school grounds when students may be present. This is a level 2 background screening. Participating bidders must take this into consideration when bidding on this contract. Prior to the start of any work/project/contract the awarded vendor must schedule with the district, dates and time with which to have the assigned personnel finger printed by the school district. The School District will notify the awarded vendor the names of those employee(s) that will be allowed to work on School District property. The School District reserves the right to check, at random, any person hired by the awarded vendor working on School District premises to see that the vendor is in compliance of this requirement. The awarded vendor must certify that the company and its employees are, or will be, in compliance with these standards for each project/contract awarded, prior to the finger printing process.

The fee to be charged all awarded vendors shall be the same fee charged the School Board at the time the fingerprinting is performed. Currently the School District is being charged \$61.00/set of fingerprinting.

The School District of Osceola County is now Sharing Finger Print Data with other Districts, if your employee(s) have been finger printed by another School District they only need to register with our District. To do so, they must bring to the School District's Human Resources Department the following items:

1. Two (2) separate forms of identification.
 - a. One must be a State issued "photo" ID
 - b. Social Security Number

B. FELONY OFFENCES

The awarded vendor(s), by signing this bid, certifies that all his employees, who may be assigned work under this contract, and who may have access to school grounds, have not been convicted of a felony, a misdemeanor involving (a) sexual assault, (b) obscenity and related offences, (c) drugs, (d) moral turpitude, (e) physical or sexual abuse or neglect of a child or an equivalent offense in another state, and/or (f) are not listed in any sexual offender registry.

2.39 CLAIM NOTICE

The bidder shall immediately report in writing to the School Board's designated representative or agent any incident that might reasonably be expected to result in any claim under any of the coverage mentioned herein. The bidder agrees to cooperate with the School Board in promptly releasing reasonable information periodically as to the disposition of any claims, including a resume' of claims experience relating to all bidder operations at the School Board project site.

2.40 BANKRUPTCY / INSOLVENCY

At the time of bid submittal, vendor/firm shall not be in the process of or engaged in any type of proceedings in insolvency or bankruptcy, either voluntary or involuntary, or receivership proceedings. If the vendor/firm is awarded a contract for six (6) months or longer, and files for bankruptcy, insolvency or receivership, the District may, at its option, terminate and cancel said contract, in which event all rights hereunder shall immediately cease and terminate.

2.41 CONTRACT/BIDDER RELATIONSHIP

The School Board reserves the right to award one or more contracts to provide the required services as deemed to be in the best interest of the School Board.

Any awarded bidder shall provide the services required herein strictly under a contractual relationship with the School Board and is not, nor shall be, construed to be an agent or employee of the School Board. As an independent bidder the awarded bidder shall pay any and all applicable taxes required by law; shall comply with all pertinent Federal, State, and local statutes including, but not limited to, the Fair Labor Standards Act, The Americans with Disabilities Act, the Federal Civil Rights Act, and any and all relevant employment laws. The bidder shall be responsible for all income tax, FICA, and any other withholdings from its employees' or sub-bidder's wages or salaries. Benefits for same shall be the responsibility of the bidder including, but not limited to, health and life insurance, mandatory Social Security, retirement, liability/risk coverage, and workers' and unemployment compensation.

The independent bidder shall hire, compensate, supervise, and terminate members of its work force; shall direct and control the manner in which work is performed including conditions under which individuals will be assigned duties, how individuals will report, and the hours individuals will perform.

The independent bidder shall not be provided special space, facilities, or equipment by the School Board to perform any of the duties required by the contract nor shall the School Board pay for any business, travel, or training expenses or any other contract performance expenses not specifically set forth in the specifications.

The independent bidder shall not be exclusively bound to the School Board and may provide professional services to other private and public entities as long as it is not in direct conflict and does not provide a conflict of interest with the services to be performed for the School Board.

2.42 NEW MATERIAL

Unless otherwise provided for in this specification, the bidder represents and warrants that the goods, materials, supplies, or components offered to the School District under this Bid solicitation are new, not used or reconditioned, and are not of such age or so deteriorated as to impair their usefulness or safety and that the goods, materials, supplies, or components offered are current production models of the respective manufacturer. If the bidder believes that furnishing used or reconditioned goods, materials, supplies, or components will be in the School Board's interest, the bidder shall so notify the School District Buyer in writing no later than ten (10) working days prior to the date set for opening of Bids. The notice shall include the reasons for the request and any benefits that may accrue to the School District if the Buyer authorizes the Bidding of used or reconditioned goods, materials, supplies, or components.

2.43 DAMAGES

Due to the nature of the services to be provided and the potential impact to the School District for loss of *fencing*, the bidder cannot disclaim consequential or inconsequential damages related to the performance of this contract. The bidder shall be responsible and accountable for any and all damages, directly or indirectly, caused by the actions or inaction of its employees, staff, or sub-consultants. There are no limitations to this liability.

2.44 CONFLICT OF INTEREST FORM

All bidders shall complete and have notarized the attached disclosure form of any potential conflict of interest that the bidder may have due to ownership, other clients, contracts, or interest associated with this project.

2.45 RESOLUTION OF BID PROTESTS

The School Board Rule 7.70.V shall be followed as outlined below for the resolution of any bid protests:

- A. The School Board shall follow the procedure specified in Florida Statutes, Section 120.57(3) and as the same may be amended from time to time for the resolution of bid protests.
- B. The Purchasing Department shall provide notice of a decision or intended decision concerning a solicitation, contract award, or exceptional purchase by electronic posting.

The notice shall contain the following statement:

Failure to file a protest within the time prescribed in Section 120.57(3), Florida Statutes, or failure to post the bond or other security required by law within the time allowed for filing a bond shall constitute a waiver of proceedings under Chapter 120, Florida Statutes.

- C. Any person who is adversely affected by the intended award of a solicitation or contract by the School Board or the recommendation of the Director of Purchasing or other responsible employee of the School Board shall file with the Director of Purchasing as agent for the School Board a notice of protest in writing within 72 hours after the electronic posting of the award or intended decision, and shall file a formal written protest within ten (10) days after the date he or she has filed the notice of protest. With respect to a protest of the specifications contained in a solicitation, the notice of protest shall be filed in writing within 72 hours after the electronic posting of the solicitation, and the formal written protest shall be filed within ten (10) days after the date the notice of protest is filed. All formal written protests must be filed with a bond payable to the School District equal to 1% of the estimated contract amount (Florida Statute 287.042(2)(c)). Failure to file a notice of protest or failure to file a formal written protest and bond shall constitute a waiver of proceedings under Chapter 120, Florida Statutes. The School Board may, in its discretion, waive any procedural irregularity or defect in procedures so long as any opposing party is not materially prejudiced by such waiver. Saturdays, Sundays, and state holidays shall be excluded in the computation of the 72-hour time periods provided by this paragraph. The notice of protest and formal written protest shall be filed in the Purchasing Department between the hours of 8:00 a.m. and 4:30 p.m. upon any day the office is open for business.

The provisions specified herein constitute the exclusive remedy for any adversely affected party with respect to a bid protest. The formal written protest shall state with particularity the facts and law upon which the protest is based.

- D. Upon receipt of the formal written protest which has been timely filed, the Purchasing Director shall stop the bid solicitation process or the contract award process until the subject of the protest is resolved by final agency action, unless the School Board, by duly enacted resolution sets forth in writing the particular facts and circumstances which require the continuance of the bid solicitation process or the contract award process without delay in order to avoid an immediate and serious danger to the public health, safety or welfare.

The School Board finds that a substantial interest in the public welfare is the timely award of contracts when required as a condition of receiving grants or funds from outside sources which will be in addition to the regular school budget.

- E. The Purchasing Director shall schedule a meeting to provide an opportunity to resolve the protest by mutual agreement between the parties within seven (7) days, excluding Saturdays, Sundays, and state holidays, after receipt of a formal written protest and bond.
- F. If the Purchasing Director cannot resolve the protest by mutual agreement within the seven (7) day period referred to in Paragraph V.E above, the School Board shall conduct an informal administrative hearing, under Section 120.57(2), Florida Statutes, acting as the agency head, where there are no disputed issues of material fact. The informal hearing shall be held with notice of no less than 72 hours, excluding Saturdays, Sundays, and legal holidays within thirty (30) days of receipt of the formal written protest and bond, unless the parties, with the consent of the School Board, agree to extend the time for the hearing. The School Board shall have the right to schedule the hearing subject to these provisions.

2.46 DEFINITIONS

As used in this Bid, the following terms shall have the meanings set forth below:

Bidder: That person or entity, including employees, servants, partners, principals, agents and assignees of the person or entity that has submitted a bid proposal for the purpose of obtaining business with the School District to provide the product and/or services set forth herein.

Contract Administrator: The School District's Director of Purchasing and Warehouse or designee shall serve as Contract Administrator. The Contract Administrator shall be responsible for addressing any concerns within the scope of the contract. Any changes to the resulting contract shall be done in writing and authorized by the Director of Purchasing and Warehouse and/or the School Board Chair.

Contract: The document resulting from this solicitation between the School District and the Bidder, including this bid, along with any written addenda and other written documents, which are expressly incorporated by reference.

Contractor's Project Manager: The Project Manager has responsibility for administering this contract for the successful Bidder(s) and will be designated prior to the issue of the resulting Price Agreement or Purchase Order.

Day: The word "day" means each calendar day or accumulation of calendar days.

Director: The Director is the Director of Purchasing and Warehouse for the School District.

Exceptions to Bid: An exception is defined as the Bidder's inability or unwillingness to meet a term, condition, specification, or requirement in the manner specified in the bid.

Person or Persons: An individual, firm, partnership, corporation, association, executor, administrator, trustee, or other legal entity, whether singular or plural, masculine or feminine, as the context may require.

School Board: The word School Board refers to the elected officials of the School Board of Osceola County, Florida.

School Board's Project Manager(s): The Project Manager(s) have responsibility for the day-to-day administration of the resulting contract for the School District and will be designated prior to award of the resulting Purchase Order.

School District: The word School District refers to the entity, The School District of Osceola County, Florida.

**3.0 SUBMITTAL REQUIREMENTS
(Submit in the following order)**

- A. Completed Invitation To Bid cover page.
- B. Completed Bid Submittal Form (use attached form).
- C. Any addenda issued subsequent to the release of this solicitation must be signed and returned with the firm's bid. **Failure to return signed addenda may be cause for the bid to be considered non-responsive.**
- D. Drug free workplace Certification
- E. Debarment Certification
- F. Emergency/Storm related catastrophe-Contractor agreement form
- G. Conflict of Interest- All bidders shall properly complete, have notarized and attach with their Bid Submittal the attached notarized disclosure statement of any potential conflict of interest that the bidder may have due to ownership, other clients, contracts or interests associated with this project.
- H. List at least three (3) recent references where the proposed product has been used within the past year. Use of the attached form will aid in evaluation.
- I. Those firms located within the Osceola County, Florida, must include a copy of their County Business Tax Receipt (formerly known as an occupational license). **If a bidder is located within Osceola County, failure to have or obtain an Osceola County Business Tax Receipt prior to the bid closing date and time shall automatically render a bidder non-responsive.** Note: Charitable organizations that qualify under Florida Statute No. 205.192 are exempt from this requirement.
- J. Attach evidence of required insurance coverage or proof of insurability in the amounts indicated. If available, a properly completed ACORD Form is preferable. **Final forms must contain the correct solicitation and/or project number and School Board contact person.**

Firms that have owner/operators that have filed a "Notice of Election to be Exempt" shall submit a copy with their submittal.

Incorporated and unincorporated firms that qualify for an exemption under the Florida Worker's Compensation law in Chapter 440 Florida Statutes shall submit an executed Hold Harmless Agreement relieving the School Board of liability in the event they and/or their employees are injured while providing goods and/or services to the School Board.

- K. Hold Harmless Agreement
- L. Confidential materials – any materials that qualify as “trade secrets” shall be segregated, clearly labeled and accompanied by an executed Non-Disclosure Agreement for Confidential Materials shall be submitted in this section.
- M. All bidders shall be prepared to supply a financial statement upon request, preferably a certified audit, but a third party prepared financial statement and the latest D & B report will be accepted.
- N. All vendors, including predecessors or related vendor or entity, shall identify any litigation in which they have been involved in, including arbitration and administrative proceedings, during

the past five (5) years involving claims for excess of ten (10) percent of the contact value. Include a brief legal description of the dispute and its current status. Where the action or lawsuit involved a similar project as herein discussed, bidder shall describe the particular circumstances giving rise to the dispute.

- O.** The bidder must submit with his bid proposal the name, address, and phone number of the person(s) to be contacted for the placement of an order and the coordination of service. A contact for both regular work-hours and after-hours, weekends, and holidays must be identified.
- P.** If a vendor must subcontract any portion of a contract for any reason, he must state the name and address of the subcontractor and the name of the person to be contacted. The School District of Osceola County also reserves the right to reject a bid or any bidder if the bid names a subcontractor who has previously failed to deliver on time contracts of similar nature, or who is not in a position to perform properly this award. The School District of Osceola County reserves the right to inspect all facilities of any subcontractors in order to make a determination as to the foregoing.
- Q.** Required licenses and proof of five (5) years in business under present business name.

BID SUBMITTAL FORM

_____, 2008

TO: The School District of Osceola County, Florida
Purchasing Department, Building 2000
817 Bill Beck Blvd.
Kissimmee, Florida 34744-4495

The undersigned hereby declare that [firm name] _____
_____ has carefully examined the specifications to furnish:

Fencing, Materials and Installation, for which Bid Submittals were advertised to be received **no later than 2:00 p.m., local time, on Wednesday, September 3, 2008**, and further declare that will furnish the Fencing, Materials and Installation according to specifications.

Price Sheet is in Excel Form, under separate attachment (Exhibit "A", 6 pages)

Have you supplied all the Submittal Requirements outlined below?

- Invitation To Bid cover page
- Completed and executed Bid Submittal form
- Any addenda pertaining to this ITB
- Drug Free Certification
- Debarment Certification
- Emergency/Storm related catastrophe-Contractor agreement form
- Conflict of Interest form
- References, in accordance with Section 2.10, *Definition of Responsive and Responsible*
- Licenses / Occupational
- Proof of Insurance
- Hold Harmless Agreement and/or Notice of Election to be Exempt, if required
- Did you include a CD, as required in the section entitled **Bid Submittal Form?**
- Proof of 5 years in business under present name

Prompt Payment Terms: _____ % _____ Days; Net 45 Days

Do you accept electronic funds transfer (ETF)? YES NO

If yes, does you firm offer a discount? _____ %

Do you accept Purchase/Payment by Visa card? YES NO

The School Board reserves the right to reject any or all proposals, to waive informalities, and to accept all or any part of any proposal as they may deem to be in the best interest of the School Board.

I hereby certify that I have read and understand the requirements of this Invitation To Bid No. **SDOC 09-B-??? CJ, "Fencing, Materials and Installation"**, and that I, as the bidder, will comply with all requirements, and that I am duly authorized to execute this proposal/offer document and any contract(s) and/or other transactions required by award of this ITB.

Company _____

Per _____ (Print name)

Signature _____

Address _____

City _____ State _____ ZIP _____

Telephone _____ Fax _____

E-Mail Address: _____

Dunn & Bradstreet # _____ Fed. I.D. # _____

DRUG FREE WORKPLACE
CERTIFICATION FORM

In accordance with Florida Statute 287.087, preference shall be given to businesses with drug-free workplace programs. Whenever two or more bids are equal with respect to price, quality and service are received by the State or by any political subdivision for the procurement of commodities or contractual services, a bid received from a business that certifies that it has implemented a drug-free workplace program shall be given preference in the award process. Established procedures for processing tie bids will be followed if none of the tied vendors have a drug-free workplace program. In order to have a drug-free workplace program, a business shall:

1. Publish a statement notifying employees that the unlawful manufacture, distribution, dispensing, possession or use of a controlled substance is prohibited in the workplace and specifying the actions that will be taken against employees for violations of such prohibition.

2. Inform employees about the dangers of drug abuse in the workplace, the business's policy of maintaining a drug-free workplace, any available drug counseling, rehabilitation, and employee assistance programs and penalties that may be imposed upon employees for drug abuse violations.

3. Give each employee engaged in providing the commodities or contractual services that are under bid a copy of the statement specified in subsection (1).

4. In the statement specified in subsection (1) notify employees that as a condition of working on the commodities or contractual services that are under bid, the employee will abide by the terms of the statement and will notify the employer of any conviction of, or plea of guilty or nolo-contendere to, any violation of chapter 893 or of any controlled substance law of the United States or any state, for a violation occurring in the workplace no later than five (5) days after such conviction.

5. Impose a sanction on, or require the satisfactory participation in a drug abuse assistance or rehabilitation program if such is available in the employee's community, by any employee who is so convicted.

6. Make a good faith effort to continue to maintain a drug-free workplace through implementation of this section.

As the person authorized to sign the statement, I certify that this firm complies fully with the above requirements.

Vendor's Signature

**CERTIFICATION REGARDING DEBARMENT, SUSPENSION
INELIGIBILITY AND VOLUNTARY EXCLUSION – LOWER TIER COVERED TRANSACTIONS**

This certification is required by the regulations implementing *Executive Order 12549, Debarment and Suspension, 7 CFR Part 3017, Section 3017.510 Participants responsibilities*. The regulations were published as **Part IV of the January 30, 1989, Federal Register (pages 4722-4733)**.

***** BEFORE COMPLETING CERTIFICATION, READ INSTRUCTIONS ON NEXT PAGE *****

- (1) The prospective lower tier participant certifies, by submission of this proposal, that neither it nor its principals is presently debarred, suspended, proposed for debarment, declared ineligible, or voluntarily excluded from participation in this transaction by any Federal department of agency.
- (2) Where the prospective lower tier participant is unable to certify to any of the statements in this certification, such prospective participant shall attached an explanation to this proposal.

Organization Name

Fencing, Materials and Installation
SDOC-09-B-007 CJ

Bid Name & Number

Names and Titles of Authorized Representative(s)

Signature(s)

Date

INSTRUCTIONS FOR DEBARMENT CERTIFICATION

-
1. By signing and submitting this form, the prospective lower tier participant is providing the certification set out herein in accordance with these instructions.
 2. The certification in this clause is a material representation of fact upon which reliance was placed when this transaction was entered into. If it is later determined that the prospective lower tier participant knowingly rendered an erroneous certification, in addition to other remedies available to the Federal Government, the department of agency with which this transaction originated may pursue available remedies, including suspension and/or debarment.
 3. The prospective lower tier participant shall provide immediate written notice to the person to whom this proposal is submitted if at any time the prospective lower tier participant learns that its certification was erroneous when submitted or has become erroneous by reason of changed circumstances.
 4. The terms "covered transaction", "debarred", "suspended", "ineligible", "lower tier covered transaction", "participant", "person", "primary covered transaction", "principal", "proposal", "voluntarily exclude", as used in this clause, have the meanings set out in the Definitions and Coverage sections of rules implementing Executive Order 12549. You may contact the person to which this proposal is submitted for assistance in obtaining a copy of these regulations.
 5. The prospective lower tier participant agrees by submitting this form that, should the proposed covered transaction be entered into, it shall not knowingly enter into any lower tier covered transaction with a person who is debarred, suspended, declared ineligible, or voluntarily excluded from participation in this covered transaction, unless authorized by the department or agency with which this transaction originated.
 6. The prospective lower tier participant further agrees by submitting this form that it will include this clause titled "Certification Regarding Debarment, Suspension, Ineligibility and Voluntary Exclusion – Lower Tier Covered Transactions", without modification in all lower tier covered transactions and in all solicitations for lower tier covered transactions.
 7. A participant in a covered transaction may rely upon a certification of a perspective participant in a lower tier covered transaction that it is not debarred, suspended, ineligible, or voluntarily excluded from the covered transaction, unless it knows that the certification is erroneous. A participant may decide the method and frequency by which it determines the eligibility of its principals. Each participant may, but is not required to, check the Non-procurement List.
 8. Nothing contained in the foregoing shall be construed to require establishment of a system of records in order to render in good faith the certification required by this clause. The knowledge and information of a participant is not required to exceed that which is normally possessed by a prudent person in the ordinary course of business dealings.
 9. Except for transactions authorized under paragraph 5 of these instructions, if a participant in a covered transaction knowingly enters into a lower tier covered transaction with a person who is suspended, debarred, ineligible, or voluntarily excluded from participation in this transaction, in addition to other remedies available to the Federal Government, the department or agency with which this transaction may pursue available remedies, including suspension and/or debarment.

EMERGENCY / STORM RELATED CATASTROPHE
AGREEMENT

Due to Acts of God, Acts of Terrorism or War, any vendors working with the School District shall acknowledge and agree to the following terms and conditions. This will allow the District to obtain Federal funding if available.

CONDITIONS FOR EMERGENCY / HURRICANE OR DISASTER

It is hereby made a part of this Invitation To Bid that before, during and after a public emergency, disaster, hurricane, flood or acts of God that the municipal government, through the School District of Osceola County, shall require a "first priority" basis for goods and services. It is vital and imperative that the majority of citizens are protected from any emergency situation, which threatens public health and safety, as, determined by the School District of Osceola County. Vendor/Contractor agrees to rent/sell/lease all goods and services to the School Board of Osceola County or other government entity as opposed to a private citizen, on a first priority basis. The District expects to pay a fair and reasonable price for all products in the event of a disaster, emergency or hurricane. Vendor/Contractor shall furnish a "24-hour" phone number in the event of such an emergency.

I hereby understand and agree to the above statement:

(Signature)

(Print Name)

(Title)

Emergency Telephone Number: _____

Home Telephone Number: _____

Beeper or Cellular Phone Number: _____

CONFLICT OF INTEREST FORM

I HEREBY CERTIFY that

1. I, (*printed name*) _____, am the
 (*Title*) _____ and the duly authorized representative of the firm of (*Firm Name*) _____ whose address is _____, and that I possess the
 Legal authority to make this affidavit on behalf of myself and the firm for which I am acting; and,
2. Except as listed below, no employee, officer, or agent of the firm have any conflicts of interest, real or apparent, due to ownership, other clients, contracts, or interests associated with this project; and,
3. This Bid Submittal is made without prior understanding, agreement, or connection with any corporation, firm, or person submitting a bid for the same services, and is in all respects fair and without collusion or fraud.

EXCEPTIONS to items above (List): _____

Signature: _____
 Printed Name: _____
 Firm Name: _____
 Date: _____

STATE OF _____

COUNTY OF _____

Sworn to and subscribed before me this _____ day of _____, 20____, by
 _____, who is personally known to me or who has produced
 _____ as identification.

 NOTARY PUBLIC – STATE OF _____

Type or print name:

Commission No.: _____

Commission Expires _____

(Seal)

LIST OF REFERENCES

#1	Agency	
Address		
City, State, ZIP		
Contact Person		
Telephone		
Date(s) of Service		
Type of Service		
Comments:		
#2	Agency	
Address		
City, State, ZIP		
Contact Person		
Telephone		
Date(s) of Service		
Type of Service		
Comments:		
#3	Agency	
Address		
City, State, ZIP		
Contact Person		
Telephone		
Date(s) of Service		
Type of Service		
Comments:		

HOLD HARMLESS AGREEMENT

**Return this page ONLY if claiming exemption from the
Worker's Compensation Insurance Requirement**

I _____ am the owner of _____, an incorporated/unincorporated business operating in the State of Florida. As such, I am bound by all laws of the state of Florida, including but not limited to those regarding the workers' compensation law.

I hereby affirm that the above named business employs fewer than four employees, including myself, and therefore, the business is exempt from the statutory requirement for workers' compensation insurance for its employees.

On behalf of the business, and its employees, I hereby agree to indemnify, keep and hold harmless the School Board, Florida, its agents, officials and employees, against all injuries, deaths, losses, damages, claims, liabilities, judgments, costs and expenses, direct, indirect or consequential (including, but not limited to, fees and charges of attorneys and other professionals) arising out of our contract with the School Board, whether or not it shall be alleged or determined that the act was caused by intention or through negligence or omission of School Board or their employees, or of their subcontractors or their employees. The named business shall pay all charges of attorneys and all costs and other expenses incurred in connection with the indemnity provided herein, and if any judgment shall be rendered against the School Board in any action indemnified hereby, the named business shall, at its own expense, satisfy and discharge the same. The foregoing is not intended nor should it be construed as, a waiver of sovereign immunity of the SCHOOL BOARD under Section 768.28, Florida Statutes.

Signature

Printed Name

Firm Name

Date

STATE OF _____

COUNTY OF _____

Sworn to and subscribed before me this _____ day of _____, 20____, by _____, who is personally known to me or who has produced _____ as identification.

NOTARY PUBLIC – STATE OF _____

Type or print name:

Commission No.: _____

(Seal)Commission Expires _____



NON-DISCLOSURE AGREEMENT
For
CONFIDENTIAL MATERIALS

Reference # _____

RETURN THIS FORM *ONLY* IF CONFIDENTIAL MATERIALS ARE BEING INCLUDED IN THE SUBMITTAL. PLEASE READ THE SECTION IN THE BID DOCUMENT TO DETERMINE IF THIS APPLIES. THE CONFIDENTIAL MATERIALS WILL ONLY BE HANDED OUT TO THE SELECTION COMMITTEE ON THE DAY OF THE EVALUATION, THEREFORE, THE EVALUATION OF THIS MATERIAL WILL BE LIMITED TO THAT TIME ONLY.

Respondent:

Address:

This Agreement is entered into as of the date of the last signature set forth below between the School District of Osceola County, a political subdivision of the State of Florida (the "District"), and the above named Respondent (hereinafter the "Respondent"). The School District of Osceola County and the Respondent are collectively referred to as the "Parties" and may be referred to individually as a Party.

RECITALS

WHEREAS, the Respondent possesses certain confidential trade secret materials that it wishes to disclose to the School District of Osceola County for the purpose of responding to a request for proposal or otherwise conducting business with the School District; and

WHEREAS, the School District desires to review such materials in order to evaluate the District's interest in negotiating and concluding an agreement for the purchase of certain products and services, or otherwise conducting business with the Respondent.

NOW THEREFORE, in consideration of the mutual promises and premises contained herein, the receipt and sufficiency of which are hereby acknowledged, the School District and the Respondent agree as follows:

1. Confidential Materials. The Respondent warrants and represents to the School District that the materials described in the attached Exhibit A (the "Confidential Materials") constitute trade secrets as defined by Section 812.081(1)(c), Florida Statutes, or financial statements required by the School District for projects as defined in 119.071(1)(c), Florida Statutes. Subject to the terms and conditions of this Agreement, the School District agrees not to disclose such Confidential Materials to third parties.

2. Additional Materials. During the course of the negotiations or the business relationship with the School District, the Respondent may disclose additional confidential or trade secret information to the District in which case the restrictions and obligations on the use and disclosure of the Confidential Materials imposed by this Agreement shall also apply to such additional information to the extent permitted by Florida law. Any such additional confidential or trade secret information shall be duly marked and stamped “confidential” or “trade secret” prior to delivery to the School District, and shall be subject to this Agreement and Section 812.081(2), Florida Statutes, only if written receipt is provided by the School District acknowledging receipt of such materials.

3. Exclusions. For purposes of this Agreement, the term “Confidential Materials” does not include the following:

- (a) Information already known or independently developed by the School District;
- (b) Information in the public domain through no wrongful act of the School District;
- (c) Information received by the School District from a third party who was legally free to disclose it;
- (d) Information disclosed by the Respondent to a third party without restriction on disclosure;
- (e) Information disclosed by requirement of law or judicial order, including without limitation Chapter 119 Florida Statutes; or
- (f) Information that is disclosed with the prior written consent of the Respondent, but only to the extent permitted by such consent.

4. Non Disclosure by Respondent. In the event that the School District discloses confidential or trade secret information to Respondent, the Respondent agrees to not disclose such information to any third party or copy such information or use it for any purpose not explicitly set forth herein without the School District’s prior written consent. Further, upon conclusion of discussions or business transactions between the School District and the Respondent, or at any time upon request of the School District, Respondent agrees to return such information (including any copies) to the School District.

5. Duty of Care. Each Party agrees to treat the other Party’s confidential or trade secret information with the same degree of care, but not less than reasonable care, as the receiving Party normally takes to preserve and protect its own similar confidential information and to inform its employees of the confidential nature of the disclosing Party’s information and of the requirement of nondisclosure. In the event either Party has actual knowledge of a breach of the nondisclosure requirements set forth in this Agreement, the Party acquiring such knowledge shall promptly inform the other Party and assist that Party in curing the disclosure, where possible, and preventing future disclosures.

6. Limitations of Florida Law. Respondent understands and agrees that its assertion that any item is confidential or a trade secret does not, in and of itself, render such material exempt from the Florida Public Records Law, Chapter 119 of the Florida Statutes, and that the School District's ability to prevent disclosure of confidential and trade secret information may be subject to determination by a Florida court that such materials qualify for trade secret protection under Florida law. In the event a third party makes a public records request for the Confidential Materials or other materials deemed by Respondent to be confidential or a trade secret, the School District may submit the materials to the court for inspection in camera as set forth in Section 119.07(1)(e) Florida Statutes. Respondent further understands that the School District may be required to disclose such information if directed by a court of competent jurisdiction.

7. Indemnification by Respondent. In the event of any litigation instituted by a third party to compel the School District to disclose such materials, Respondent shall, at its sole cost and expense, provide assistance to the School District in defending the denial of the records request, and shall hold the School District harmless from any claim for statutory costs and attorneys fees arising from the School District's refusal to disclose such materials.

8. No Additional Obligations. This Agreement shall not be construed in any manner to be an obligation for either Party to enter into any subsequent contract or agreement.

9. Sovereign Immunity. Nothing in this Agreement shall be deemed as a waiver of immunity or limits of liability of the School District beyond any statutory limited waiver of immunity or limits of liability, which has been or which may be adopted by the Florida Legislature, regardless of the nature of any claim which may arise, including but not limited to a claim sounding in tort, equity or contract. In no event shall the School District be liable for any claim or claims for breach of contract, including without limitation the wrongful disclosure of confidential or trade secret information for an amount which exceeds, individually and collectively, the then current statutory limits of liability for tort claims. Nothing in this Agreement shall inure to the benefit of any third party for the purpose of allowing any claim against the School District, which would otherwise be barred under the Doctrine of Sovereign Immunity or by operation of law.

10. Notice. Whenever either Party desires to give notice unto the other, it must be given by written notice, sent by registered United States mail, with return receipt requested, addressed to the party for whom it is intended, at the place last specified, and the place for giving of notice in compliance with the provisions of this paragraph. For the present, the Respondent designates the address set forth above as its place for receiving notice, and the School District designates the following address for such notice:

The School District of Osceola County, Florida
Director of Purchasing and Warehouse
817 Bill Beck Blvd., Building 2000
Kissimmee, Florida 34744

11. Governing Law. This Agreement shall be governed by the laws of the State of Florida, and venue for any action arising out of or relating to the subject matter of this Agreement shall be exclusively in Osceola County, Florida, or the Federal District Court for the Middle District of Florida, Orlando Division.

12. Respondent and the School District hereby expressly waive any rights either may have to a trial by jury of any civil litigation related to this Agreement for any litigation limited solely to the parties of this Agreement.

IN WITNESS WHEREOF, the parties hereto have caused this Agreement to be executed by their duly authorized officers the day and year as set forth below.

The School District of Osceola County, Florida

Respondent

BY: _____

BY: _____

NAME: Dr. Michael A. Grego

NAME: _____

TITLE: Superintendent

TITLE: _____

DATE: _____

DATE: _____

ATTEST:

BY: _____

NAME: _____

TITLE: _____

DATE: _____

EXHIBIT A
DESCRIPTION OF CONFIDENTIAL MATERIALS

**Notification Regarding Public Entity Crime and Discriminatory Vendor List Requirements
And Disqualification Provision**

A. Pursuant to Florida Statutory requirements, potential Respondents are notified:

287.133(2)(a) A person or affiliate who has been placed on the convicted vendor list following a conviction for a public entity crime may not submit a bid, proposal, or reply on a contract to provide any goods or services to a public entity; may not submit a bid, proposal, or reply on a contract with a public entity for the construction or repair of a public building or public work; may not submit bids, proposals, or replies on leases of real property to a public entity; may not be awarded or perform work as a contractor, supplier, subcontractor, or consultant under a contract with any public entity; and may not transact business with any public entity in excess of the threshold amount provided in s. 287.017 for CATEGORY TWO for a period of 36 months following the date of being placed on the convicted vendor list.

287.133(2)(b) A public entity may not accept any bid, proposal, or reply from, award any contract to, or transact any business in excess of the threshold amount provided in s. 287.017 for CATEGORY TWO with any person or affiliate on the convicted vendor list for a period of 36 months following the date that person or affiliate was placed on the convicted vendor list unless that person or affiliate has been removed from the list pursuant to paragraph (3)(f). A public entity that was transacting business with a person at the time of the commission of a public entity crime resulting in that person being placed on the convicted vendor list may not accept any bid, proposal, or reply from, award any contract to, or transact any business with any other person who is under the same, or substantially the same, control as the person whose name appears on the convicted vendor list so long as that person's name appears on the convicted vendor list.

287.134(2)(a) An entity or affiliate who has been placed on the discriminatory vendor list may not submit a bid, proposal, or reply on a contract to provide any goods or services to a public entity; may not submit a bid, proposal, or reply on a contract with a public entity for the construction or repair of a public building or public work; may not submit bids, proposals, or replies on leases of real property to a public entity; may not be awarded or perform work as a contractor, supplier, subcontractor, or consultant under a contract with any public entity; and may not transact business with any public entity.

287.134(2)(b) A public entity may not accept any bid, proposals, or replies from, award any contract to, or transact any business with any entity or affiliate on the discriminatory vendor list for a period of 36 months following the date that entity or affiliate was placed on the discriminatory vendor list unless that entity or affiliate has been removed from the list pursuant to paragraph (3)(f). A public entity that was transacting business with an entity at the time of the discrimination resulting in that entity being placed on the discriminatory vendor list may not accept any bid, proposal, or reply from, award any contract to, or transact any business with any other entity who is under the same, or substantially the same, control as the entity whose name appears on the discriminatory vendor list so long as that entity's name appears on the discriminatory vendor list.

B. By submitting a proposal, the Respondent represents and warrants that the submission of its proposal does not violate Section 287.133, Florida Statutes (2005), nor Section 287.134, Florida Statutes (2005).

C. In addition to the foregoing, the Respondent represents and warrants that Respondent, Respondent's subcontractors and Respondent's implementer, if any, is not under investigation for violation of such statutes.

D. Respondent should read carefully all provisions of 287.133 and 287.134, Florida Statutes (2005).

STATEMENT OF NO BID

The School District of Osceola County, Florida
Purchasing Department
817 Bill Beck Boulevard, Building 2000
Kissimmee, Florida 34744-4495

Attn: Cheryl Jessee – Senior Buyer

Bid # _____

We, the undersigned, have decided not to bid for the following reasons.

- _____ We do not handle products/services in this classification
- _____ Opening date does not allow sufficient time to complete bid
- _____ Cannot supply at this time
- _____ Suitable but engaged in other work
- _____ Quantity too small
- _____ Cannot meet required delivery
- _____ Equivalent not presently available
- _____ Unable to meet specifications
- _____ Unable to meet insurance/bond requirements
- _____ Please remove our name from the vendor file only for the commodity listed above
- _____ Please remove our name from the School Board’s entire vendor files
- _____ Other reasons or remarks

We understand that if the “No Bid” letter is not returned by the bid due date, our name may be deleted from the School District of Osceola County’s vendor list for this commodity.

Company Name _____

Authorized Signature _____

Print Name of Authorized Person _____

Email Address for Authorized Person _____

Telephone Number _____

Fax Number _____

ATTACHMENT A
PAGES 43-57

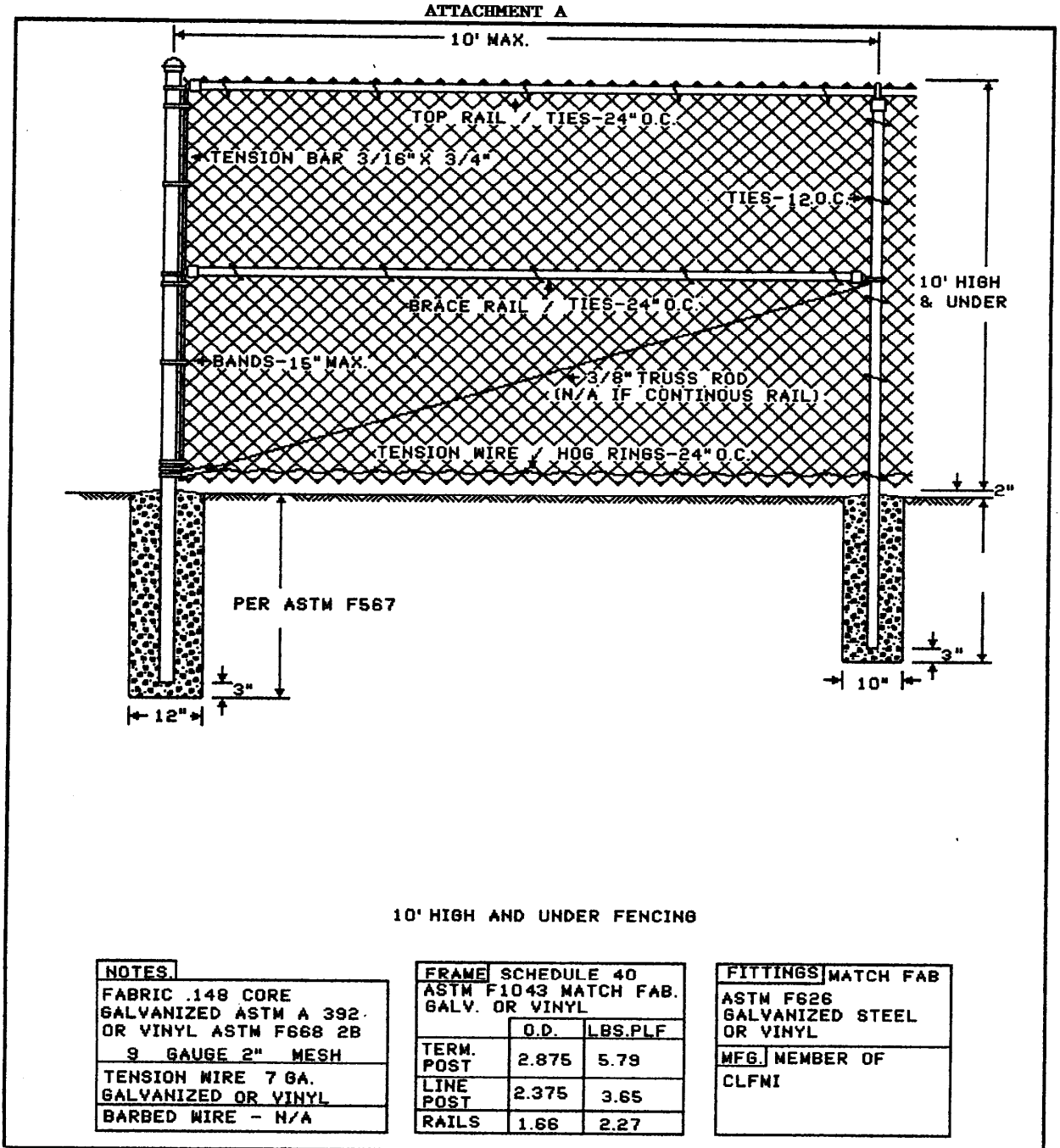

ATTACHMENT A

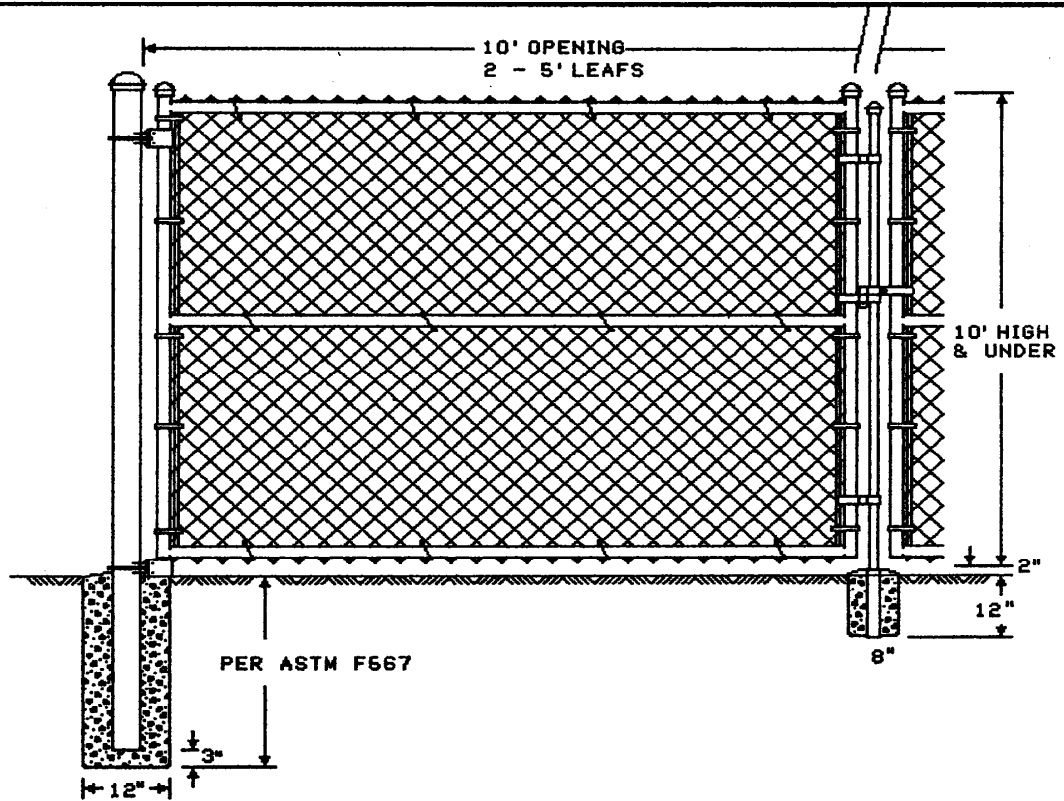

10' WIDE X
10' HIGH AND UNDER

NOTES
FABRIC .148 CORE GALVANIZED ASTM A 392 OR VINYL ASTM F668 2B 9 GAUGE 2" MESH
TENSION WIRE - N/A
BARBED WIRE - N/A

FRAME	SCHEDULE 40	
	ASTM F1043 MATCH FAB. GALV. OR VINYL	
	O.D.	LBS.PLF
GATE POST	2.875	5.79
GATE FRAME RAILS	1.90	2.72

FITTINGS	MATCH FAB
ASTM F626 GALVANIZED STEEL OR VINYL	
NFG. MEMBER OF CLFMI	

ATTACHMENT A

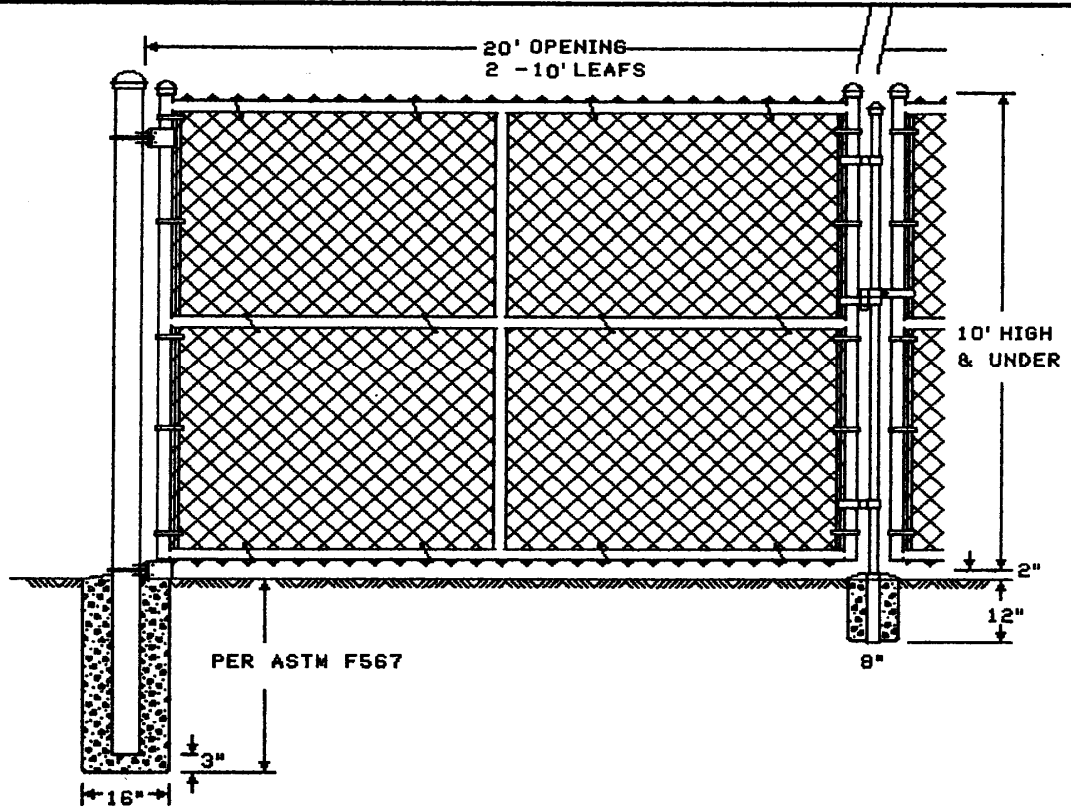

20' WIDE X
10' HIGH AND UNDER

NOTES
FABRIC .148 CORE GALVANIZED - ASTM A392 OR VINYL ASTM F668 2B
9 GAUGE 2" MESH
TENSION WIRE - N/A
BARBED WIRE - N/A

FRAME	SCHEDULE 40	
	ASTM F1043 MATCH FAB. GALV. OR VINYL	
	O.D.	LBS.PLF
GATE POST	4.00	9.10
GATE FRAME	1.90	2.72
RAILS		

FITTINGS	MATCH FAB
ASTM F626 GALVANIZED STEEL OR VINYL	
MFG. MEMBER OF CLFMI	

ATTACHMENT A

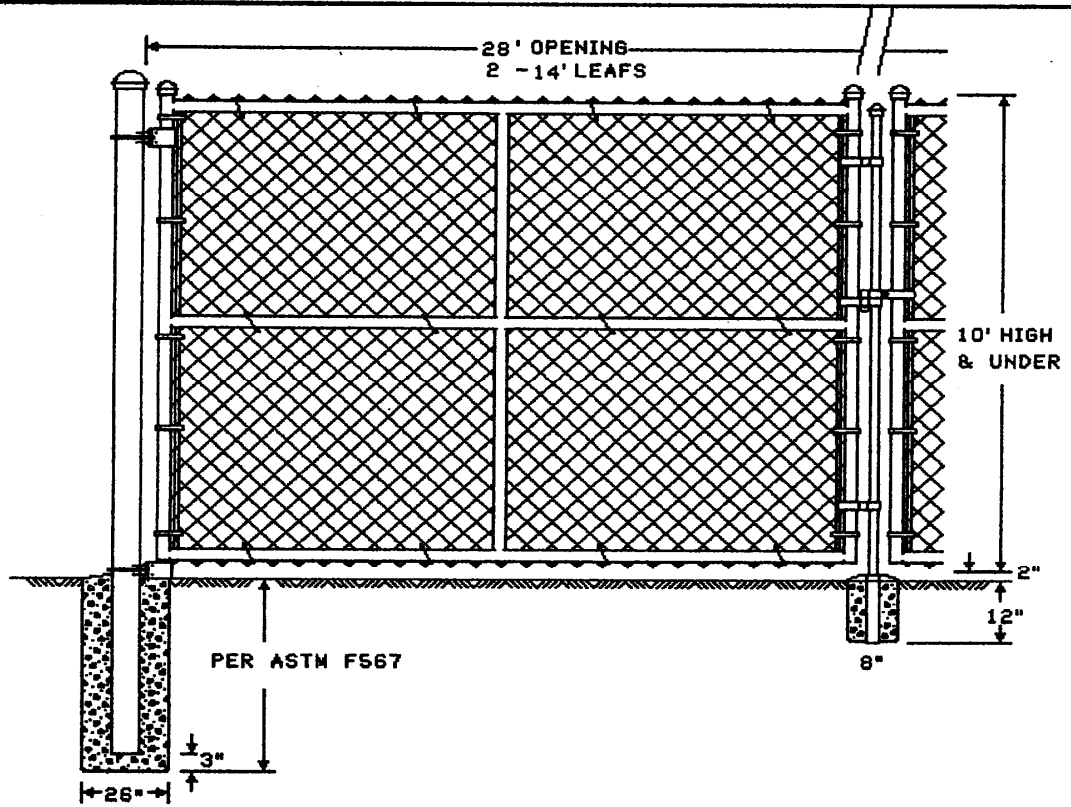

28' WIDE X
10' HIGH AND UNDER

NOTES
FABRIC .149 CORE GALVANIZED ASTM A392 OR VINYL ASTM F668 2B
9 GAUGE 2" MESH
TENSION WIRE - N/A
BARBED WIRE - N/A

FRAME	SCHEDULE 40	
	ASTM F1043 MATCH FAB. GALV. OR VINYL	
	O.D.	LBS.PLF
GATE POST	6.625	18.99
GATE FRAME	1.90	2.72
RAILS		

FITTINGS	MATCH FAB
ASTM F626 GALVANIZED STEEL OR VINYL	
MFG. MEMBER OF CLFMI	

ATTACHMENT A

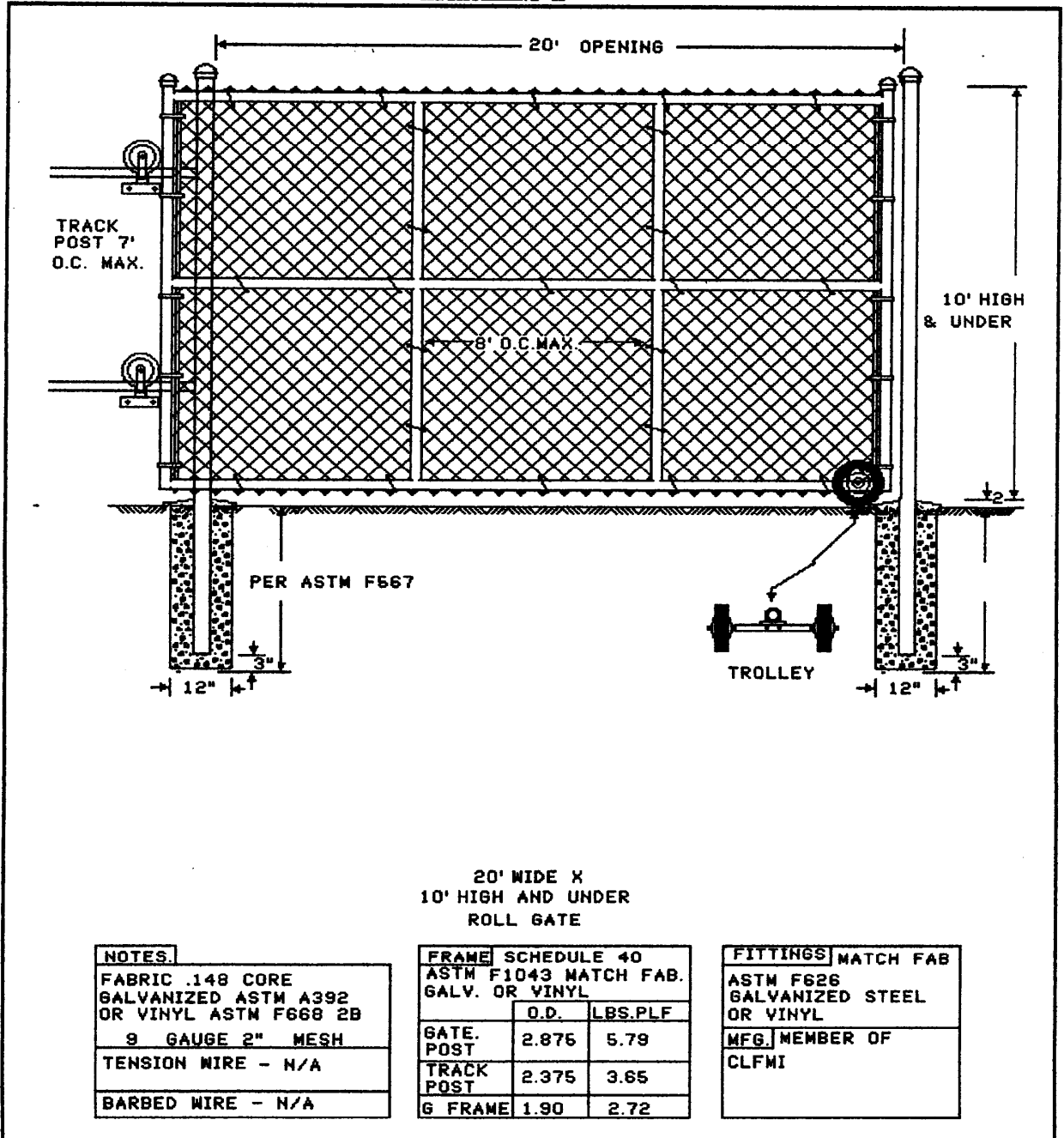

ATTACHMENT A

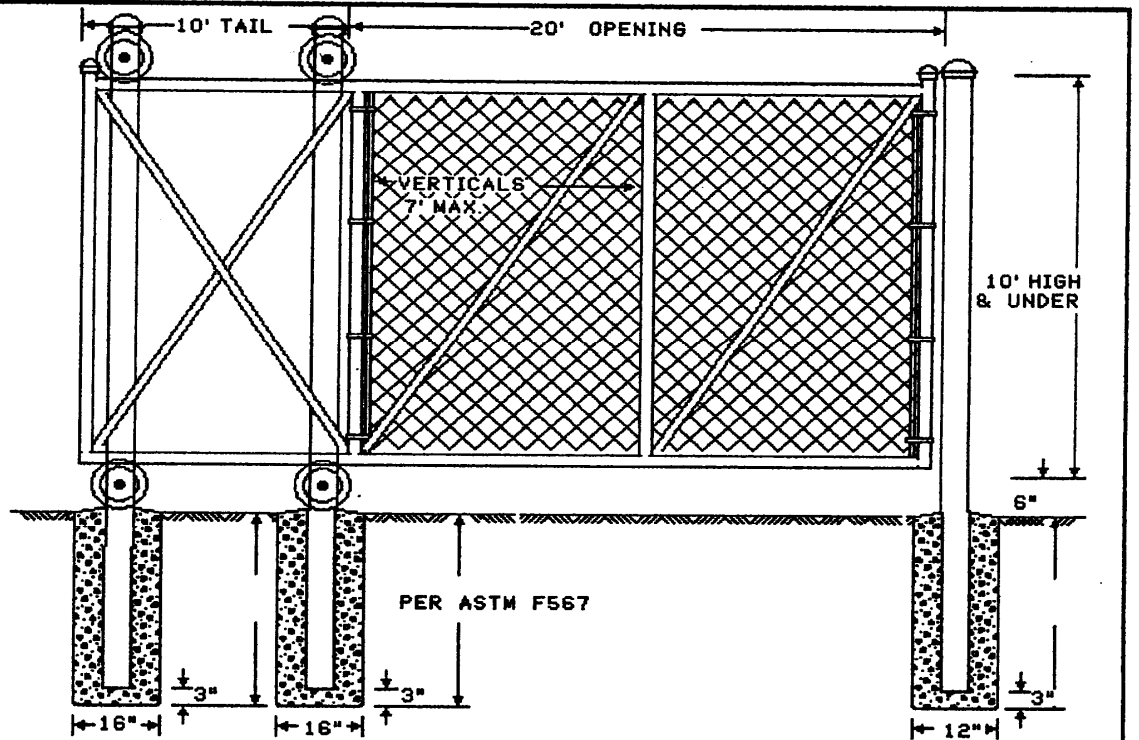

OPENING BETWEEN POST - 20'
 GATE SIZE FOR OPENING - 20' 6"
 TAIL SECTION - 10'

20' WIDE X
 10' HIGH AND UNDER
 CANTILEVER GATE

FRAME SCHEDULE 40 ASTM F1043 MATCH FAB. GALV. OR VINYL		
	O.D.	LBS.PLF
TERM. POST	4.00	9.10
LATCH POST	2.875	6.79
GATE FRAME		
TOP & BOTTOM	2.375	3.65
HORZ & DIA.	1.66	2.27
VERT.	1.90	2.72

NOTES
FABRIC .148 CORE GALVANIZED ASTM A392 OR VINYL ASTM F668 2B 9 GAUGE 2" MESH
TENSION WIRE 7 GA. GALVANIZED OR VINYL
BARBED WIRE - N/A

FITTINGS MATCH FAB
ASTM F626 GALVANIZED STEEL OR VINYL
MFG. MEMBER OF CLFMI

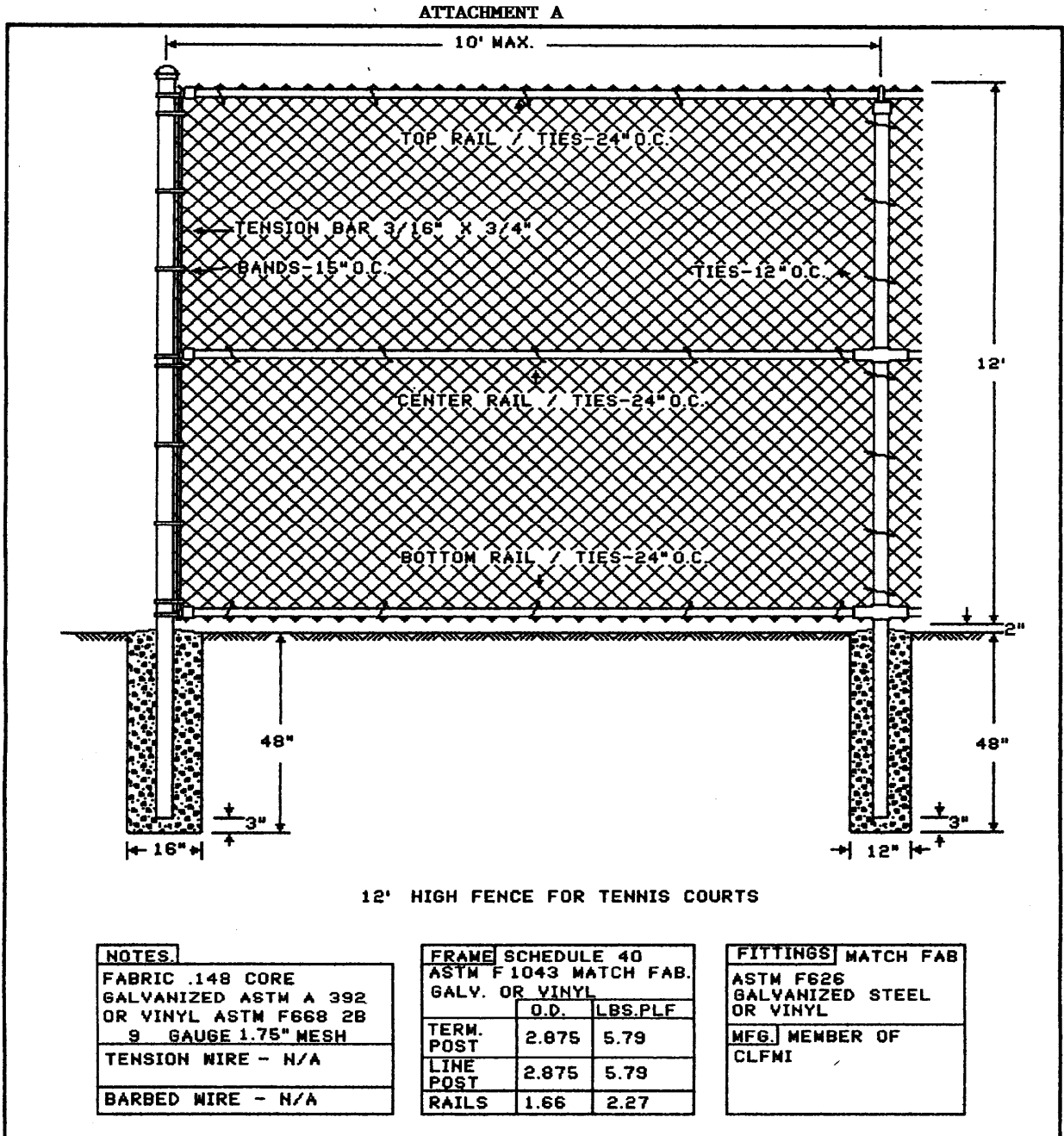

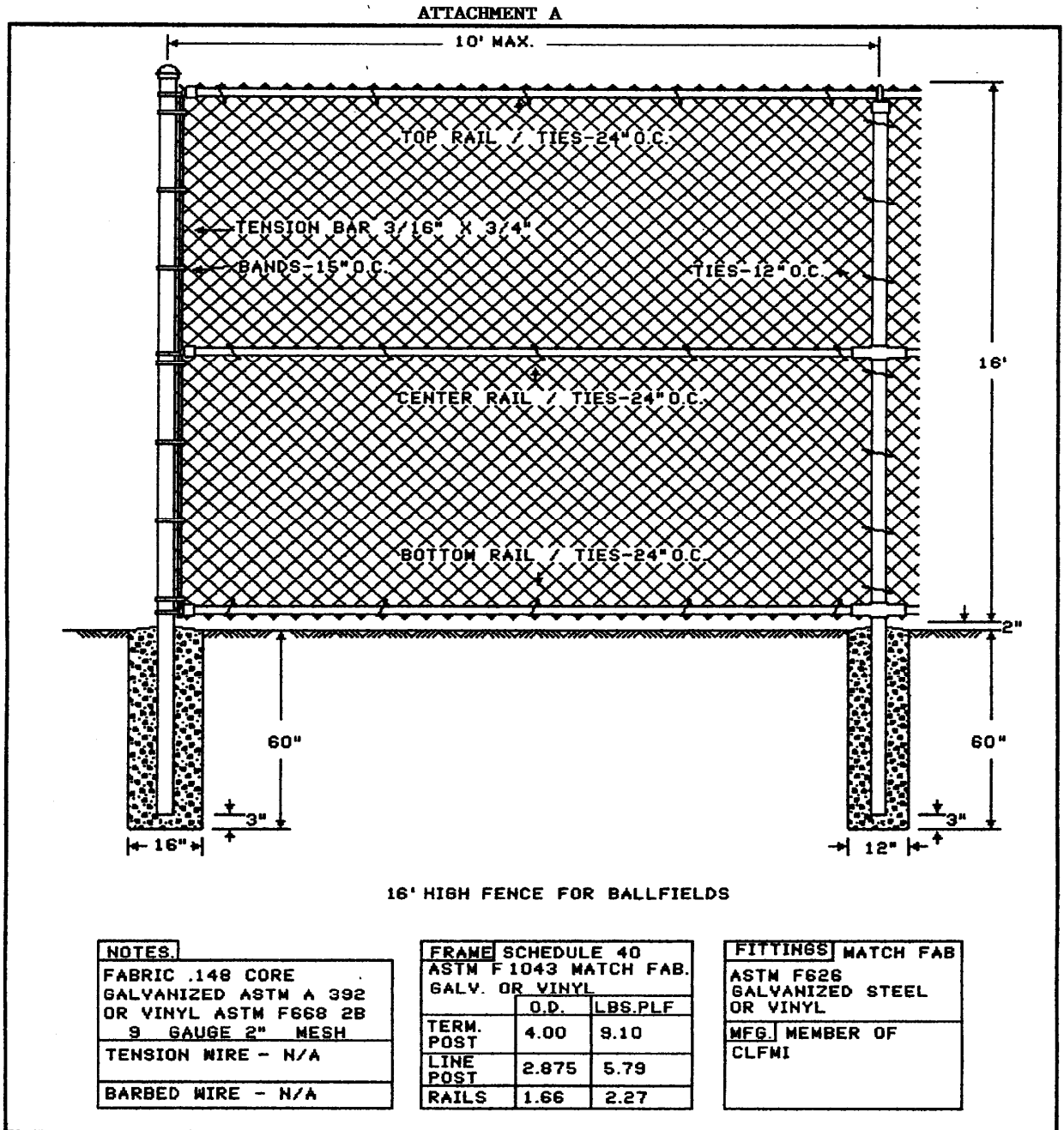

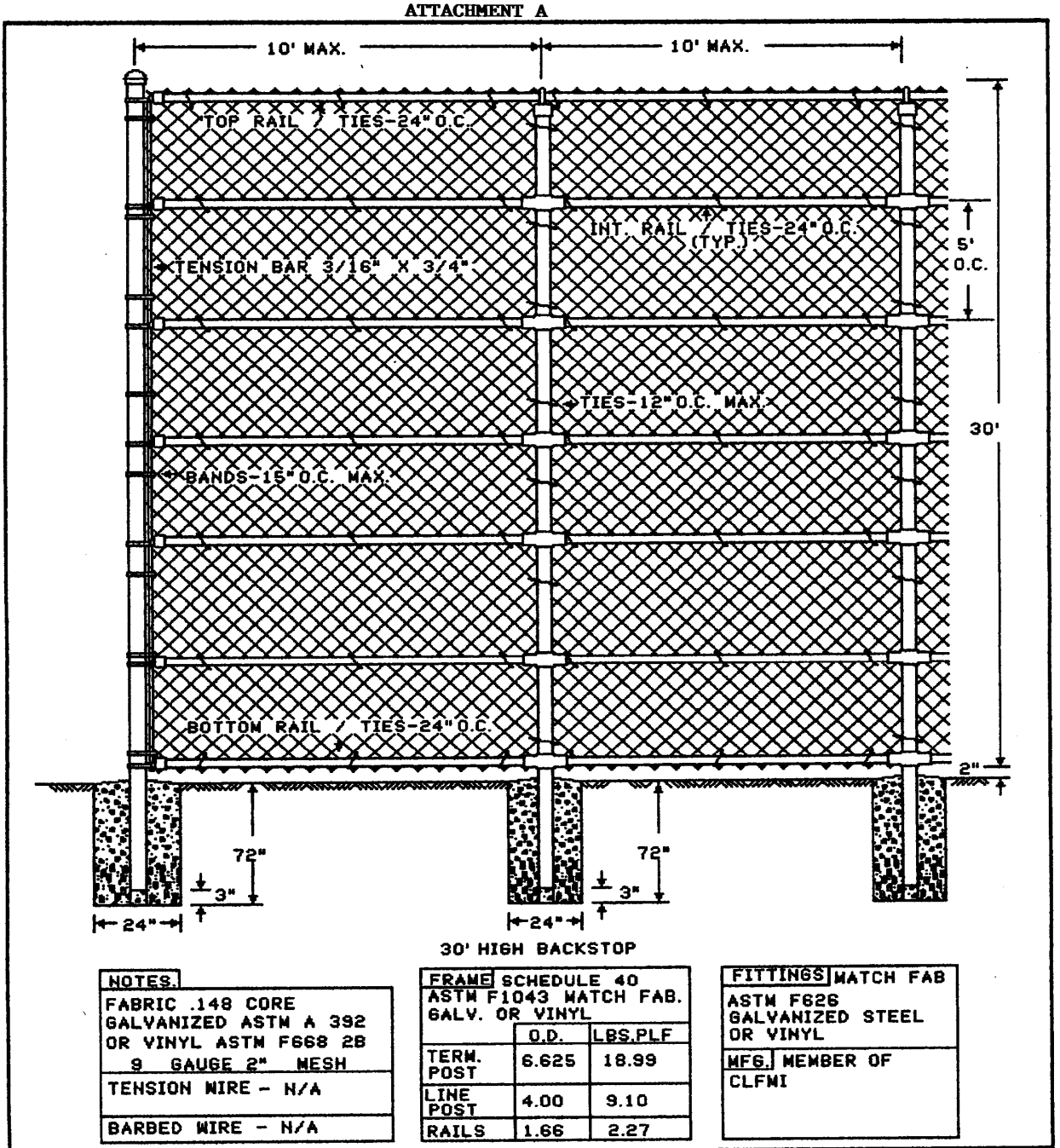

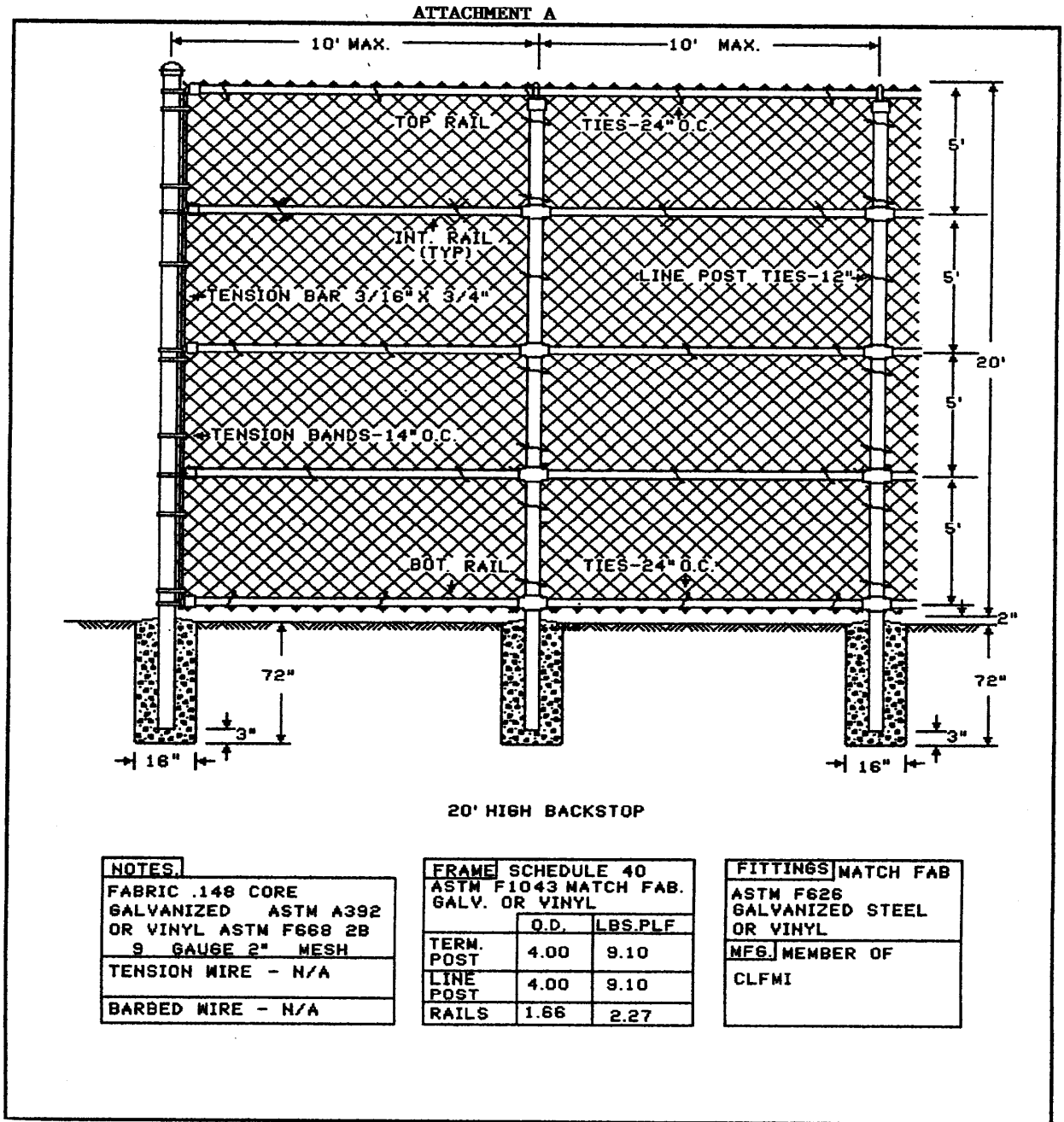

ATTACHMENT A

BACKSTOP LAYOUT

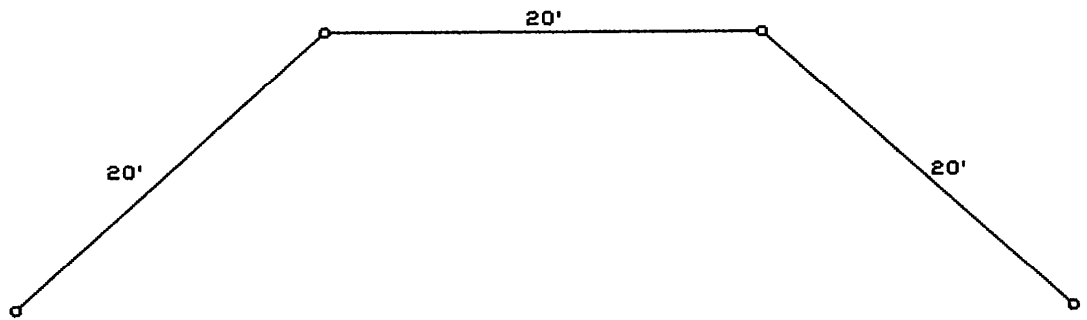

ATTACHMENT A

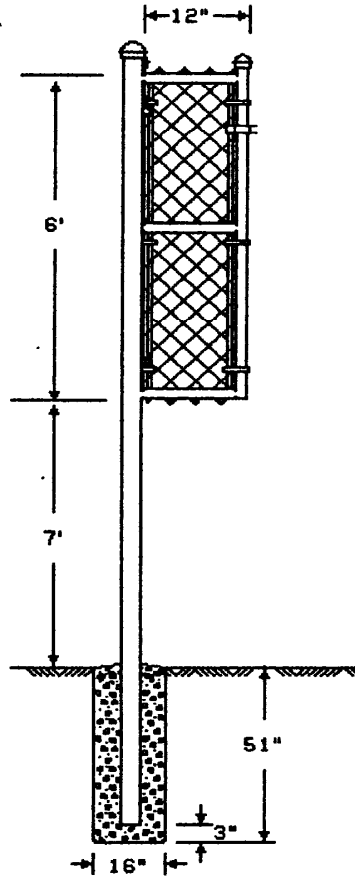

FOUL POLE DETAIL

NOTES
FABRIC .192 CORE GALVANIZED ASTM A392 PAINT TRAFFIC YELLOW 6 GAUGE 2" MESH
TENSION WIRE N/A
BARBED WIRE - N/A

FRAME	SCHEDULE 40 ASTM F1043 POLY COAT OR SPRAYPAINT T. YELLOW	
	O.D.	LBS. PLF
MAIN POST	4.00	9.10
SCREEN FRAME	1.90	2.72
RAILS		

FITTINGS
ASTM F626 GALVANIZED STEEL PAINTED T. YELLOW
MFG. MEMBER OF CLFMI

ATTACHMENT A

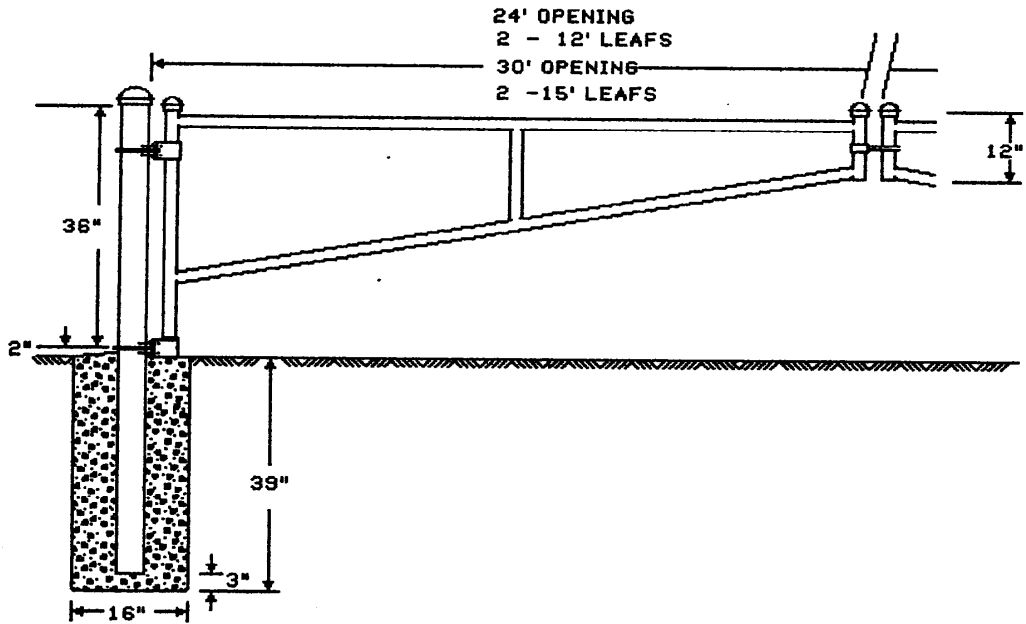

24' X 3' BARRIER GATE
OR
30' X 3' BARRIER GATE

NOTES		
FRAME	SCHEDULE 40 ASTM F1043 POLY COAT OR SPRAYPAINT T. YELLOW	
	O.D.	LBS. PLF
GATE, POST	4.00	9.10
GATE FRAME	1.90	2.72

FITTINGS	
ASTM F626 GALVANIZED STEEL PAINT YELLOW	
MFG.	MEMBER
CLFMI	